

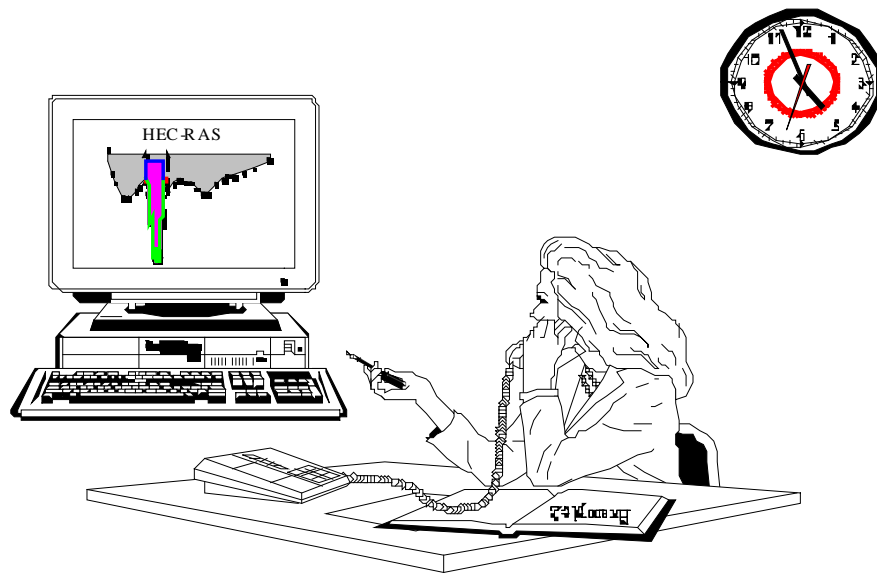

**US Army Corps  
of Engineers**  
Hydrologic Engineering Center

---

# HEC-RAS



## River Analysis System

Applications Guide

Version 5.0  
February 2016

Approved for Public Release. Distribution Unlimited

CPD-70

<b>REPORT DOCUMENTATION PAGE</b>			<i>Form Approved</i> <i>OMB No. 0704-0188</i>	
Public reporting burden for this collection of information is estimated to average 1 hour per response, including the time for reviewing instructions, searching existing data sources, gathering and maintaining the data needed, and completing and reviewing the collection of information. Send comments regarding this burden estimate or any other aspect of this collection of information, including suggestions for reducing this burden, to Washington Headquarters Services, Directorate for Information Operations and Reports, 1215 Jefferson Davis Highway, Suite 1204, Arlington, VA 22202-4302, and to the Office of Management and Budget, Paperwork Reduction Project (0704-0188), Washington, DC 20503.				
<b>1. AGENCY USE ONLY</b> <i>(Leave blank)</i>	<b>2. REPORT DATE</b> February, 2016	<b>3. REPORT TYPE AND DATES COVERED</b> Computer Program Documentation		
<b>4. TITLE AND SUBTITLE</b> HEC-RAS, River Analysis System Applications Guide			<b>5. FUNDING NUMBERS</b>	
<b>6. AUTHOR(S)</b> Gary W. Brunner, John C. Warner, Brent C. Wolfe, Steven S. Piper, and Landon Marston				
<b>7. PERFORMING ORGANIZATION NAME(S) AND ADDRESS(ES)</b> US ARMY CORPS OF ENGINEERS HYDROLOGIC ENGINEERING CENTER (HEC) 609 Second Street Davis, CA 95616-4687			<b>8. PERFORMING ORGANIZATION REPORT NUMBER</b> CPD-70	
<b>9. SPONSORING / MONITORING AGENCY NAME(S) AND ADDRESS(ES)</b>			<b>10. SPONSORING / MONITORING AGENCY REPORT NUMBER</b>	
<b>11. SUPPLEMENTARY NOTES</b>				
<b>12a. DISTRIBUTION / AVAILABILITY STATEMENT</b> Approved for Public Release. Distribution is unlimited.			<b>12b. DISTRIBUTION CODE</b>	
<p><b>13. ABSTRACT</b> <i>(Maximum 200 words)</i></p> <p>The U.S. Army Corps of Engineers' River Analysis System (HEC-RAS) is software that allows you to perform one-dimensional steady and unsteady flow river hydraulics calculations.</p> <p>HEC-RAS is an integrated system of software, designed for interactive use in a multi-tasking, multi-user network environment. The system is comprised of a graphical user interface (GUI), separate hydraulic analysis components, data storage and management capabilities, graphics and reporting facilities.</p> <p>The HEC-RAS system contains four one-dimensional hydraulic analysis components for: (1) steady flow water surface profile computations; (2) unsteady flow simulation; (3) movable boundary sediment transport computations; and (4) temperature and water quality constituent transport modeling.. A key element is that all four components use a common geometric data representation and common geometric and hydraulic computation routines. In addition to the four hydraulic analysis components, the system contains several hydraulic design features that can be invoked once the basic water surface profiles are computed.</p>				
<b>14. SUBJECT TERMS</b> water surface profiles, river hydraulics, steady and unsteady flow, One-dimensional and two-dimensional hydrodynamics, computer program			<b>15. NUMBER OF PAGES</b> 521	
			<b>16. PRICE CODE</b>	
<b>17. SECURITY CLASSIFICATION OF REPORT</b> UNCLASSIFIED	<b>18. SECURITY CLASSIFICATION OF THIS PAGE</b> UNCLASSIFIED	<b>19. SECURITY CLASSIFICATION OF ABSTRACT</b> UNCLASSIFIED	<b>20. LIMITATION OF ABSTRACT</b> UNLIMITED	

# **HEC-RAS**

# **River Analysis System**

## **Applications Guide**

**Version 5.0**

**February 2016**

US Army Corps of Engineers  
Institute for Water Resources  
Hydrologic Engineering Center  
609 Second Street  
Davis, CA 95616

(530) 756-1104  
(530) 756-8250 FAX  
[www.hec.usace.army.mil](http://www.hec.usace.army.mil)

## **River Analysis System, HEC-RAS**

The HEC-RAS executable code and documentation was developed with U.S. Federal Government resources and is therefore in the public domain. It may be used, copied, distributed, or redistributed freely. However, it is requested that HEC be given appropriate acknowledgment in any subsequent use of this work.

HEC cannot provide technical support for this software to non-Corps users. See our software vendors list (on our web page) to locate organizations that provide the program, documentation, and support services for a fee. However, we will respond to all documented instances of program errors. Documented errors are bugs in the software due to programming mistakes not model problems due to user-entered data.

This document contains references to product names that are trademarks or registered trademarks of their respective owners. Use of specific product names does not imply official or unofficial endorsement. Product names are used solely for the purpose of identifying products available in the public market place.

Microsoft, Windows, and Excel are registered trademarks of Microsoft Corp.  
ArcView is a trademark of ESRI, Inc.

## **Terms and Conditions of Use:**

Use of the software described by this document is controlled by certain terms and conditions. The user must acknowledge and agree to be bound by the terms and conditions of usage before the software can be installed or used. The software described by this document can be downloaded for free from our internet site ([www.hec.usace.army.mil](http://www.hec.usace.army.mil)).

The United States Government, US Army Corps of Engineers, Hydrologic Engineering Center ("HEC") grants to the user the rights to install Watershed Analysis Tool (HEC-RAS) "the Software" (either from a disk copy obtained from HEC, a distributor or another user or by downloading it from a network) and to use, copy and/or distribute copies of the Software to other users, subject to the following Terms and Conditions for Use:

All copies of the Software received or reproduced by or for user pursuant to the authority of this Terms and Conditions for Use will be and remain the property of HEC.

User may reproduce and distribute the Software provided that the recipient agrees to the Terms and Conditions for Use noted herein.

HEC is solely responsible for the content of the Software. The Software may not be modified, abridged, decompiled, disassembled, unobfuscated or reverse engineered. The user is solely responsible for the content, interactions, and effects of any and all amendments, if present, whether they be extension modules, language resource bundles, scripts or any other amendment.

The name "HEC-RAS" must not be used to endorse or promote products derived from the Software. Products derived from the Software may not be called "HEC- RAS " nor may any part of the "HEC- RAS " name appear within the name of derived products.

No part of this Terms and Conditions for Use may be modified, deleted or obliterated from the Software.

No part of the Software may be exported or re-exported in contravention of U.S. export laws or regulations.

### **Waiver of Warranty:**

THE UNITED STATES GOVERNMENT AND ITS AGENCIES, OFFICIALS, REPRESENTATIVES, AND EMPLOYEES, INCLUDING ITS CONTRACTORS AND SUPPLIERS PROVIDE HEC-WAT "AS IS," WITHOUT ANY WARRANTY OR CONDITION, EXPRESS, IMPLIED OR STATUTORY, AND SPECIFICALLY DISCLAIM ANY IMPLIED WARRANTIES OF TITLE, MERCHANTABILITY, FITNESS FOR A PARTICULAR PURPOSE AND NON-INFRINGEMENT. Depending on state law, the foregoing disclaimer may not apply to you, and you may also have other legal rights that vary from state to state.

**Limitation of Liability:**

IN NO EVENT SHALL THE UNITED STATES GOVERNMENT AND ITS AGENCIES, OFFICIALS, REPRESENTATIVES, AND EMPLOYEES, INCLUDING ITS CONTRACTORS AND SUPPLIERS, BE LIABLE FOR LOST PROFITS OR ANY SPECIAL, INCIDENTAL OR CONSEQUENTIAL DAMAGES ARISING OUT OF OR IN CONNECTION WITH USE OF HEC-WAT REGARDLESS OF CAUSE, INCLUDING NEGLIGENCE.

THE UNITED STATES GOVERNMENT'S LIABILITY, AND THE LIABILITY OF ITS AGENCIES, OFFICIALS, REPRESENTATIVES, AND EMPLOYEES, INCLUDING ITS CONTRACTORS AND SUPPLIERS, TO YOU OR ANY THIRD PARTIES IN ANY CIRCUMSTANCE IS LIMITED TO THE REPLACEMENT OF CERTIFIED COPIES OF HEC-WAT WITH IDENTIFIED ERRORS CORRECTED. Depending on state law, the above limitation or exclusion may not apply to you.

**Indemnity:**

As a voluntary user of HEC- RAS you agree to indemnify and hold the United States Government, and its agencies, officials, representatives, and employees, including its contractors and suppliers, harmless from any claim or demand, including reasonable attorneys' fees, made by any third party due to or arising out of your use of HEC- RAS or breach of this Agreement or your violation of any law or the rights of a third party.

**Assent:**

By using this program you voluntarily accept these terms and conditions. If you do not agree to these terms and conditions, uninstall the program and return any program materials to HEC (if you downloaded the program and do not have disk media, please delete all copies, and cease using the program.)

## Table of Contents

Table of Contents.....	i
FOREWORD.....	IX
INTRODUCTION.....	XI
<i>HEC-RAS Documentation</i> .....	xii
<i>Overview of this Manual</i> .....	xii
<b>CHAPTER 1.....</b>	<b>1-1</b>
CRITICAL CREEK.....	1-1
<i>Purpose</i> .....	1-1
<i>Subcritical Flow Analysis</i> .....	1-1
Geometric Data.....	1-1
Flow Data.....	1-3
Steady Flow Analysis.....	1-4
Subcritical Flow Output Review.....	1-5
<i>Mixed Flow Analysis</i> .....	1-10
Modification of Existing Geometry.....	1-11
Flow Data.....	1-13
Mixed Flow Analysis.....	1-14
Review of Mixed Flow Output.....	1-14
<i>Summary</i> .....	1-16
<b>CHAPTER 2.....</b>	<b>2-1</b>
BEAVER CREEK - SINGLE BRIDGE.....	2-1
<i>Purpose</i> .....	2-1
<i>Pressure/Weir Flow Analysis</i> .....	2-1
River System Schematic.....	2-2
Cross Section Geometric Data.....	2-3
Bridge Geometry Data.....	2-8
Ineffective Flow Areas.....	2-13
Bridge Modeling Approach.....	2-14
Steady Flow Data.....	2-16
Pressure/Weir Flow Simulation.....	2-19
Review of Pressure/Weir Flow Output.....	2-19
<i>Energy Method Analysis</i> .....	2-22
Energy Method Data and Simulation.....	2-22
Review of Energy Method Output.....	2-22
<i>Evaluation of Cross Section Locations</i> .....	2-23
Expansion Reach Length.....	2-23
Contraction Reach Length.....	2-25
Expansion Coefficient.....	2-27
Contraction Coefficient.....	2-27
<i>Model Calibration</i> .....	2-28
<i>Comparison of Energy and Pressure/Weir Flow Methods to Observed Data</i> .....	2-30
<i>Summary</i> .....	2-33
<b>CHAPTER 3.....</b>	<b>3-1</b>
SINGLE CULVERT (MULTIPLE IDENTICAL BARRELS).....	3-1
<i>Purpose</i> .....	3-1
<i>Geometric Data</i> .....	3-1
River System Schematic.....	3-1
Cross Section Geometry.....	3-2
Cross Section Placement.....	3-4
Culvert Data.....	3-8
<i>Steady Flow Data</i> .....	3-14

*Table of Contents*

---

Flow Data .....	3-14
Boundary Conditions .....	3-15
<i>Steady Flow Analysis</i> .....	3-17
<i>Output Analysis</i> .....	3-17
Expansion and Contraction Reach Length Evaluation .....	3-18
Channel Contraction and Expansion Coefficients .....	3-20
Water Surface Profiles .....	3-21
<i>Summary</i> .....	3-27
<b>CHAPTER 4.....</b>	<b>4-1</b>
MULTIPLE CULVERTS .....	4-1
<i>Purpose</i> .....	4-1
<i>Geometric Data</i> .....	4-1
River System Schematic .....	4-1
Cross Section Geometry .....	4-2
Expansion and Contraction Reach Lengths .....	4-2
Culvert Data .....	4-3
Ineffective Flow Areas .....	4-8
<i>Steady Flow Data</i> .....	4-8
<i>Steady Flow Analysis</i> .....	4-9
<i>Output Analysis</i> .....	4-9
Expansion and Contraction Reach Lengths .....	4-9
Channel Expansion and Contraction Coefficients .....	4-12
Water Surface Profiles .....	4-12
<i>Summary</i> .....	4-16
<b>CHAPTER 5.....</b>	<b>5-1</b>
MULTIPLE OPENINGS .....	5-1
<i>Purpose</i> .....	5-1
<i>River System Geometric Data</i> .....	5-1
River System Schematic .....	5-2
Cross Section Geometry .....	5-2
Placement of the Cross Sections .....	5-2
<i>Bridge Geometry</i> .....	5-3
Deck/Roadway Data .....	5-3
Piers and Abutments .....	5-5
Bridge Modeling Approach .....	5-6
<i>Culvert Geometry</i> .....	5-6
<i>Multiple Openings</i> .....	5-7
Stagnation Limits .....	5-8
Ineffective Flow Areas .....	5-10
Manning's n Values .....	5-10
<i>Cross Section Locations</i> .....	5-11
Expansion Reach Length .....	5-11
Contraction Reach Length .....	5-13
Coefficients of Expansion and Contraction .....	5-13
<i>Steady Flow Analysis</i> .....	5-14
<i>Multiple Opening Output Analysis</i> .....	5-14
Cross Section Placement Evaluation .....	5-15
Water Surface Profiles .....	5-15
Multiple Opening Profile Table .....	5-16
<i>Summary</i> .....	5-19
<b>CHAPTER 6.....</b>	<b>6-1</b>
FLOODWAY DETERMINATION .....	6-1
Purpose .....	6-1
<i>Floodplain Encroachment Analysis Procedure</i> .....	6-1
<i>Base Flood Profile</i> .....	6-3
<i>Method 5 Optimization Procedure</i> .....	6-4



Method 5 Steady Flow Data .....	6-4
Method 5 Encroachment Data .....	6-4
Method 5 Output Review.....	6-6
<i>Method 4 Encroachment Analysis - Trial 1</i> .....	6-7
Method 4 Steady Flow Data - Trial 1 .....	6-8
Method 4 Encroachment Data - Trial 1 .....	6-9
Method 4 Output - Trial 1.....	6-10
<i>Method 4 Encroachment Analysis - Trial 2</i> .....	6-12
Method 4 Steady Flow Data - Trial 2 .....	6-12
Method 4 Encroachment Data - Trial 2 .....	6-12
Method 4 Output - Trial 2.....	6-13
<i>Method 4 Encroachment Analysis - Trial 3</i> .....	6-16
<i>Method 1 Encroachment Analysis</i> .....	6-18
Method 1 Steady Flow Data .....	6-18
Method 1 Encroachment Data .....	6-18
Method 1 Output.....	6-18
<i>Summary</i> .....	6-20
<b>CHAPTER 7.....</b>	<b>7-1</b>
MULTIPLE PLANS .....	7-1
<i>Purpose</i> .....	7-1
<i>Elements of a Project</i> .....	7-1
<i>Elements of a Plan</i> .....	7-2
<i>Existing Conditions Analysis</i> .....	7-3
Existing Conditions Geometry.....	7-3
Steady Flow Data.....	7-5
Existing Conditions Plan .....	7-6
Existing Conditions Output .....	7-7
<i>Proposed Conditions Analysis</i> .....	7-8
Proposed Conditions Geometric Data.....	7-8
Steady Flow Data.....	7-9
Proposed Conditions Plan.....	7-10
Proposed Conditions Output.....	7-10
<i>Comparison of Existing and Proposed Plans</i> .....	7-10
Profile Plot.....	7-10
Cross Section Plots .....	7-12
Standard Table.....	7-13
Bridge Only Table .....	7-13
X-Y-Z Perspective Plot.....	7-14
<i>Summary</i> .....	7-15
<b>CHAPTER 8.....</b>	<b>8-1</b>
LOOPED NETWORK.....	8-1
<i>Purpose</i> .....	8-1
<i>Geometric Data</i> .....	8-1
River System Schematic .....	8-1
Cross Section Data.....	8-2
Stream Junction Data.....	8-2
<i>Steady Flow Data</i> .....	8-3
Profile Data.....	8-4
Boundary Conditions.....	8-5
<i>Steady Flow Analysis</i> .....	8-5
<i>Analysis of Results for Initial Flow Distribution</i> .....	8-6
<i>Steady Flow Analysis with New Flow Distribution</i> .....	8-7
<i>Analysis of Results for Final Flow Distribution</i> .....	8-8
<i>Summary</i> .....	8-8
<b>CHAPTER 9.....</b>	<b>9-1</b>
MIXED FLOW ANALYSIS.....	9-1
<i>Purpose</i> .....	9-1

*Table of Contents*

---

<i>Geometric Data</i> .....	9-1
River System Schematic .....	9-1
Cross Section Data.....	9-2
Location of the Cross Sections .....	9-2
<i>Bridge Data</i> .....	9-4
<i>Steady Flow Data</i> .....	9-7
Profile Data.....	9-7
Boundary Conditions .....	9-8
<i>Steady Flow Analysis</i> .....	9-9
<i>Review of Output for Energy Analysis</i> .....	9-10
Water Surface Profile .....	9-10
Water Surface Profiles for Subcritical and Supercritical Flow Analyses.....	9-13
Profile Table - Bridge Comparison .....	9-14
Cross Section Table - Bridge.....	9-15
<i>Pressure/Weir Analysis</i> .....	9-16
<i>Review of Output for Pressure/Weir Analysis</i> .....	9-18
Water Surface Profile .....	9-18
Expansion and Contraction Reach Lengths .....	9-19
Bridge Comparison Table.....	9-20
Bridge Detailed Output Table.....	9-21
X-Y-Z Perspective Plot.....	9-22
<i>Summary</i> .....	9-23
<b>CHAPTER 10.....</b>	<b>10-1</b>
STREAM JUNCTION .....	10-1
<i>Purpose</i> .....	10-1
<i>Geometric Data</i> .....	10-1
River System Schematic .....	10-1
Cross Section Placement.....	10-2
Cross Section Data.....	10-4
Stream Junction Data - Energy Method.....	10-4
<i>Steady Flow Data</i> .....	10-6
<i>Steady Flow Analysis (Stream Junction Energy Method)</i> .....	10-8
<i>Review of Output for Stream Junction Energy Analysis</i> .....	10-8
Water Surface Profile .....	10-9
Standard Table 2.....	10-9
<i>Steady Flow Analysis (Stream Junction Momentum Method)</i> .....	10-11
<i>Review of Output for Stream Junction Momentum Analysis</i> .....	10-12
Water Surface Profile .....	10-12
Standard Table 2.....	10-13
<i>Comparison of Energy and Momentum Results</i> .....	10-14
<i>Summary</i> .....	10-16
<b>CHAPTER 11.....</b>	<b>11-1</b>
BRIDGE SCOUR.....	11-1
<i>Purpose</i> .....	11-1
<i>Geometric Data</i> .....	11-1
<i>Steady Flow Data</i> .....	11-3
<i>Steady Flow Analysis</i> .....	11-4
<i>Hydraulic Design - Bridge Scour</i> .....	11-5
Contraction Scour.....	11-6
Pier Scour .....	11-8
Abutment Scour.....	11-9
Total Bridge Scour.....	11-10
<i>Summary</i> .....	11-12
<b>CHAPTER 12.....</b>	<b>12-1</b>
INLINE STRUCTURE .....	12-1

<i>Purpose</i> .....	12-1
<i>Geometric Data</i> .....	12-1
Cross Section Data.....	12-2
Inline Structure .....	12-2
Gated Spillways.....	12-5
Ineffective Flow Areas .....	12-7
Cross Section Placement.....	12-8
<i>Steady Flow Data</i> .....	12-9
Flow Profiles .....	12-9
Boundary Conditions.....	12-10
Gate Openings .....	12-11
<i>Steady Flow Analysis</i> .....	12-12
<i>Output Analysis</i> .....	12-13
Water Surface Profiles.....	12-13
Inline Structure Detailed Output Table.....	12-14
Inline Structure Profile Summary Table.....	12-17
<i>Summary</i> .....	12-18
<b>CHAPTER 13</b> .....	<b>13-1</b>
BOGUE CHITTO - SINGLE BRIDGE (WSPRO).....	13-1
<i>Purpose</i> .....	13-1
<i>Geometric Data</i> .....	13-2
River System Schematic .....	13-2
Cross Section Geometric Data .....	13-3
Cross Section Placement.....	13-4
Bridge Geometry Data.....	13-7
Ineffective Flow Areas .....	13-11
Bridge Modeling Approach .....	13-14
<i>Steady Flow Data</i> .....	13-18
<i>Steady Flow Analysis</i> .....	13-20
<i>Review of Output</i> .....	13-21
Water Surface Profiles.....	13-21
Profile Tables.....	13-22
Detailed Output Tables.....	13-25
<i>Evaluation of Cross Section Locations</i> .....	13-26
Expansion Reach Length .....	13-27
Contraction Reach Length.....	13-28
Expansion and Contraction Coefficients.....	13-29
<i>Summary</i> .....	13-29
<b>CHAPTER 14</b> .....	<b>14-1</b>
ICE-COVERED RIVER .....	14-1
<i>Purpose</i> .....	14-1
<i>Open Water Analysis</i> .....	14-1
Open Water Geometry.....	14-2
Steady Flow Data.....	14-2
Open Water Plan.....	14-2
Open Water Output.....	14-3
<i>Ice Cover Analysis</i> .....	14-3
Ice Cover Geometry.....	14-3
Steady Flow Data.....	14-3
Ice Cover Plan .....	14-3
Ice Cover Output .....	14-4
<i>Ice Jam Analysis</i> .....	14-4
Ice Jam Geometry.....	14-4
Steady Flow Data.....	14-5
Ice Jam Plan.....	14-5
Ice Jam Output.....	14-5
<i>Comparison of Open Water, Ice Cover, and Ice Jam Results</i> .....	14-6
Profile Plot.....	14-6
Ice Table.....	14-7

<b>CHAPTER 15.....</b>	<b>15-1</b>
SPLIT FLOW JUNCTION WITH LATERAL WEIR/SPILLWAY .....	15-1
<i>Purpose</i> .....	15-1
Geometric Data.....	15-1
Stream Junction Data.....	15-2
Cross Section Data.....	15-3
Lateral Structure .....	15-3
Gated Spillway .....	15-6
<i>Steady Flow Data</i> .....	15-8
Flow Profiles .....	15-8
Boundary Conditions .....	15-9
Gate Openings .....	15-10
<i>Steady Flow Analysis</i> .....	15-11
<i>Output Analysis</i> .....	15-13
Water Surface Profiles.....	15-13
Lateral Structure Detailed Output Table.....	15-14
Lateral Structure Profile Summary Table.....	15-15
Junctions Profile Summary Table.....	15-16
Standard Profile Summary Table.....	15-17
<i>Additional Adjustments</i> .....	15-17
Junction Flow Split.....	15-18
Lateral Structure Flow Split.....	15-18
<i>Summary</i> .....	15-18
<b>CHAPTER 16.....</b>	<b>16-1</b>
CHANNEL MODIFICATION.....	16-1
<i>Purpose</i> .....	16-1
<i>Geometric Data</i> .....	16-1
Channel Modification Data.....	16-1
Performing the Channel Modifications.....	16-4
Saving the Channel Modifications.....	16-4
<i>Steady Flow Analysis</i> .....	16-5
<i>Comparing Existing and Modified Conditions</i> .....	16-5
Steady Flow Analysis .....	16-5
Water Surface Profiles.....	16-6
Cross Section Plots .....	16-8
X-Y-Z Perspective Plot.....	9
Standard Table.....	10
<i>Summary</i> .....	11
<b>CHAPTER 17.....</b>	<b>17-1</b>
UNSTEADY FLOW APPLICATION .....	17-1
<i>Purpose</i> .....	17-1
<i>Geometric Data</i> .....	17-1
General Description.....	17-1
Creating Storage Areas.....	17-3
Entering Data for a Storage Area.....	17-5
Lateral Structure Connected to a Storage Area.....	17-7
Storage Area Connections .....	17-10
Parameters for Hydraulic Tables .....	17-12
Cross Section Table Parameters .....	17-13
<i>Unsteady Flow Data</i> .....	17-14
Boundary Conditions .....	17-14
Upstream Boundary Condition.....	17-15
Downstream Boundary Condition .....	17-17
Initial Conditions.....	17-18
<i>Unsteady Flow Analysis</i> .....	17-19
Simulation Time Window.....	17-20
Computation Settings .....	17-21

Location of Stage and Flow Hydrographs .....	17-21
<i>Unsteady Flow Simulation</i> .....	17-22
Geometry Pre-processor (HTAB) .....	17-22
Unsteady Flow Simulation and the Post-Processor.....	17-24
<i>Summary</i> .....	17-29
<b>CHAPTER 18.....</b>	<b>18-1</b>
ADVANCED INLINE STRUCTURE MODELING.....	18-1
<i>Purpose</i> .....	18-1
<i>Geometric Data</i> .....	18-1
General Geometric Features .....	18-2
Inline Structure .....	18-3
<i>Unsteady Flow Data</i> .....	18-10
Boundary Conditions.....	18-11
Upstream Boundary Condition .....	18-12
Downstream Boundary Condition .....	18-13
Internal Boundary Conditions.....	18-14
Initial Conditions.....	18-16
<i>Unsteady Flow Analysis</i> .....	18-17
<i>Output Analysis</i> .....	18-19
Water Surface Profiles.....	18-19
Inline Structure Detailed Output Table.....	18-19
Inline Structure Profile Summary Table .....	18-20
<i>Summary</i> .....	18-21
<b>CHAPTER 19.....</b>	<b>19-1</b>
HYDROLOGIC UNSTEADY ROUTING – MODIFIED PULS.....	19-1
<i>Purpose</i> .....	19-1
<i>Geometric Data</i> .....	19-1
<i>Unsteady Flow Data</i> .....	19-2
Boundary Conditions.....	19-3
Upstream Boundary Condition .....	19-4
Downstream Boundary Condition .....	19-5
Initial Conditions.....	19-6
<i>Steady Flow Analysis</i> .....	19-8
Purpose .....	19-8
Steady Flow Data.....	19-8
Boundary Conditions.....	19-9
Steady Flow Computations.....	19-11
<i>Hydrologic Unsteady Routing</i> .....	19-11
<i>Unsteady Flow Analysis</i> .....	19-15
Simulation Time Window.....	19-16
Computation Settings .....	19-16
Programs to Run .....	19-17
Location of Stage and Flow Hydrographs .....	19-17
<i>Output Analysis</i> .....	19-18
Water Surface Profiles.....	19-18
Stage and Flow Hydrographs.....	19-19
Full Unsteady Flow and Hydrologic Unsteady Routing Comparison.....	19-19
<i>Summary</i> .....	19-20
<b>CHAPTER 20.....</b>	<b>20-1</b>
HAGER’S LATERAL WEIR EQUATION .....	20-1
<i>Purpose</i> .....	20-1
Geometric Data.....	20-1
Cross Section Data.....	20-2
Lateral Structure .....	20-3
Lateral Weir Embankment – Hager’s Equation .....	20-4
<i>Unsteady Flow Data</i> .....	20-7
<i>Unsteady Flow Analysis</i> .....	20-8

## Table of Contents

---

<i>Output Analysis</i> .....	20-10
Water Surface Profiles.....	20-10
Lateral Structure Detailed Output Table.....	20-10
Lateral Structure Profile Summary Table.....	20-12
<i>Summary</i> .....	20-13
<b>CHAPTER 21.....</b>	<b>21-1</b>
OVERFLOW GATES .....	21-1
<i>Purpose</i> .....	21-1
<i>Geometric Data</i> .....	21-1
Cross Section Data.....	21-2
Inline Structure.....	21-3
Ineffective Flow Areas .....	21-6
Creating Storage Areas.....	21-7
Entering Data for a Storage Area.....	21-7
Lateral Structure Connected to a Storage Area.....	21-8
Storage Area Connections .....	21-11
<i>Unsteady Flow Data</i> .....	21-14
Boundary Conditions.....	21-15
Upstream Boundary Condition.....	21-15
Downstream Boundary Condition .....	21-16
Internal Boundary Conditions.....	21-16
Initial Conditions.....	21-18
<i>Unsteady Flow Analysis</i> .....	21-20
<i>Output Analysis</i> .....	21-21
Water Surface Profiles.....	21-21
Detailed Output Tables.....	21-21
Profile Summary Table.....	21-23
<i>Summary</i> .....	21-24
<b>CHAPTER 22.....</b>	<b>22-1</b>
GROUNDWATER INTERFLOW .....	22-1
<i>Purpose</i> .....	22-1
<i>Geometric Data</i> .....	22-1
River System Schematic.....	22-1
Cross Section Geometry .....	22-3
Creating Storage Areas.....	22-3
Entering Data for a Storage Area.....	22-3
Lateral Structure Connected to a Storage Area.....	22-4
<i>Unsteady Flow Data</i> .....	22-6
Boundary Conditions.....	22-7
Upstream Boundary Condition.....	22-9
Downstream Boundary Condition .....	22-10
Groundwater Interflow (Internal Boundary Condition).....	22-10
Initial Conditions.....	22-12
<i>Unsteady Flow Analysis</i> .....	22-14
Simulation Time Window.....	22-15
Computation Settings .....	22-15
Programs to Run .....	22-16
Location of Stage and Flow Hydrographs .....	22-16
Flow Distribution Locations.....	22-17
<i>Output Analysis</i> .....	22-18
Stage and Flow Hydrographs.....	22-18
DSS Plot.....	22-20
<i>Summary</i> .....	22-21
<b>CHAPTER 23.....</b>	<b>23-1</b>
URBAN MODELING .....	23-1
<i>Purpose</i> .....	23-1

<i>Geometric Data</i> .....	23-1
<i>Subsurface Modeling</i> .....	23-2
Cross Section Data.....	23-3
Minor Losses .....	23-4
Stream Junction Data.....	23-5
<i>Surface Modeling</i> .....	23-6
Creating Storage Areas .....	23-6
Entering Data for a Storage Area.....	23-6
Storage Area Connections .....	23-7
Lateral Structure Connected to a Storage Area.....	23-9
Levee (Lateral Structure) Breach Data .....	23-12
Inline Structure .....	23-13
Pump Station .....	23-16
Cross Section Hydraulic Table Parameters.....	23-19
<i>Unsteady Flow Data</i> .....	23-20
Boundary Conditions .....	23-21
Upstream Boundary Conditions.....	23-22
Downstream Boundary Condition .....	23-23
Internal Boundary Conditions.....	23-24
Initial Conditions.....	23-26
<i>Unsteady Flow Analysis</i> .....	23-28
<i>Output Analysis</i> .....	23-29
Water Surface Profiles.....	23-29
Stage and Flow Hydrographs.....	23-30
<i>Summary</i> .....	23-31
<b>CHAPTER 24</b> .....	<b>24-1</b>
MANNING'S N CALIBRATION .....	24-1
<i>Purpose</i> .....	24-1
<i>Geometric Data</i> .....	24-1
Cross Section Data.....	24-2
Stream Junction Data.....	24-3
Creating Storage Areas .....	24-4
Entering Data for a Storage Area.....	24-4
Storage Area Connections .....	24-5
Lateral Structures.....	24-7
Inline Structure .....	24-9
Cross Section Table Parameters .....	24-12
<i>Unsteady Flow Data</i> .....	24-13
Boundary Conditions.....	24-14
Upstream Boundary Conditions.....	24-15
Downstream Boundary Condition .....	24-17
Internal Boundary Conditions.....	24-18
Initial Conditions.....	24-19
<i>Unsteady Flow Analysis</i> .....	24-21
<i>Calibration of Manning's n Values</i> .....	24-22
Adding Observed (Measured) Data .....	24-22
Calibration of Base Manning's n Values .....	24-23
Automatic Calibration of Manning's n .....	24-25
<i>Output Analysis</i> .....	24-29
Stage and Flow Hydrographs.....	24-29
<i>Summary</i> .....	24-30
REFERENCES.....	1





# Foreword

The U.S. Army Corps of Engineers' River Analysis System (HEC-RAS) is software that allows you to perform one-dimensional steady flow hydraulics; one and two-dimensional unsteady flow river hydraulics calculations; quasi Unsteady and full unsteady flow sediment transport-mobile bed modeling; water temperature analysis; and generalized water quality modeling (nutrient fate and transport).

The first version of HEC-RAS (version 1.0) was released in July of 1995. Since that time there have been several major releases of this software package, including versions: 1.1; 1.2; 2.0; 2.1; 2.2; 3.0, 3.1, 3.1.1, 3.1.2, 3.1.3, 4.0, 4.1 and now version 5.0 in February of 2015.

The HEC-RAS software was developed at the Hydrologic Engineering Center (HEC), which is a division of the Institute for Water Resources (IWR), U.S. Army Corps of Engineers.

The software was designed by Mr. Gary W. Brunner, leader of the HEC-RAS development team. The user interface and graphics were programmed by Mr. Mark R. Jensen. The steady flow water surface profiles computational module and the majority of the one-dimensional unsteady flow computations modules was programmed by Mr. Steven S. Piper. The One-dimensional unsteady flow matrix solution algorithm was developed by Dr. Robert L. Barkau (Author of UNET and HEC-UNET).

The two-dimensional unsteady flow modeling capabilities were developed by Gary W. Brunner, Mark R. Jensen, Steve S. Piper, Ben Chacon (Resource Management Consultants, RMA), and Alex J. Kennedy.

The sediment transport interface module was programmed by Mr. Stanford A. Gibson. The quasi Unsteady flow computational sediment transport capabilities were developed by Stanford A. Gibson and Steven S. Piper. The Unsteady flow sediment transport modules were developed by Stanford A. Gibson, Steven S. Piper, and Ben Chacon (RMA). Special thanks to Mr. Tony Thomas (Author of HEC-6 and HEC-6T) for his assistance in developing the quasi-unsteady flow sediment transport routines used in HEC-RAS.

The water quality computational modules were designed and developed by Mr. Mark R. Jensen, Dr. Cindy Lowney and Zhonglong Zhang (ERDC-RDE-EL-MS).

The spatial data and mapping tools (RAS-Mapper) were developed by Mark R. Jensen, Cameron T. Ackerman, and Alex J. Kennedy.

The interface for channel design/modifications was designed and developed by Mr. Cameron T. Ackerman and Mr. Mark R. Jensen. The stable channel design functions were programmed by Mr. Chris R. Goodell.

The routines that import HEC-2 and UNET data were developed by Ms. Joan Klipsch. The routines for modeling ice cover and wide river ice jams were developed by Mr. Steven F. Daly of the Cold Regions Research and Engineering Laboratory (CRREL).

Many other HEC staff members have made contributions in the development of this software, including: Vern R. Bonner, Richard Hayes, John Peters, Al Montalvo, and Michael Gee. Mr. Matt Fleming was the Chief of the H&H Division, and Mr. Chris Dunn was the director during the development of this version of the software.

This manual was written by John C. Warner, Gary W. Brunner, Brent C. Wolfe, Steven S. Piper, and Landon Marston.

HEC-RAS uses the following third party libraries:

1. Hierarchical Data Format (HDF) – HEC-RAS uses the HDF5 libraries in both the User Interface and the Computational engines for writing and reading data to binary files that follow the HDF5 standards. The HDF Group:  
<http://www.hdfgroup.org/HDF5/>
2. Geospatial Data Abstraction Library (GDAL) – HEC-RAS uses the GDAL libraries in the HEC-RAS Mapper tool. These libraries are use for all Geospatial data rendering, coordinate transformations, etc... GDAL: <http://www.gdal.org/>
3. Bitmiracle LibTiff .Net. LibTiff.Net provides support for the Tag Image File Format (TIFF), a widely used format for storing image data. Bitmiricle:  
<http://bitmiracle.com/libtiff/>
4. Oxyplot – 2 dimensional X-Y plots in HEC-RAS Mapper. Oxyplot:  
<http://oxyplot.org/>
5. SQLite – Reading and writing database files. SQLite: <https://www.sqlite.org/>
6. cURL - HTTP support for GDAL <http://curl.haxx.se/>

# Introduction

Welcome to the Hydrologic Engineering Center's River Analysis System (HEC-RAS). This software allows you to perform one-dimensional steady flow, one and two-dimensional unsteady flow, sediment transport calculations, and water quality computations (temperature modeling and constituent transport and fate). The HEC-RAS modeling system was developed as a part of the Hydrologic Engineering Center's "Next Generation" (NexGen) of hydrologic engineering software. The NexGen project encompasses several aspects of hydrologic engineering, including: rainfall-runoff analysis; river hydraulics; reservoir system simulation; flood damage analysis; and real-time river forecasting for reservoir operations.

This introduction discusses the documentation for HEC-RAS and provides an overview of this manual.

## Contents

- HEC-RAS Documentation
- Overview of this Manual

## HEC-RAS Documentation

The HEC-RAS package includes several documents. Each document is designed to help the user learn to use a particular aspect of the modeling system. The documentation is arranged in the following three categories:

<b>Documentation</b>	<b>Description</b>
<i>User's Manual</i>	This manual is a guide to using HEC-RAS. The manual provides an introduction and overview of the modeling system, installation instructions, how to get started, simple examples, detailed descriptions of each of the major modeling components, and how to view graphical and tabular output.
<i>Hydraulic Reference Manual</i>	This manual describes the theory and data requirements for the hydraulic calculations performed by HEC-RAS. Equations are presented along with the assumptions used in their derivation. Discussions are provided on how to estimate model parameters, as well as guidelines on various modeling approaches.
<i>Applications Guide</i>	This document contains examples that demonstrate various aspects of HEC-RAS. Each example consists of a problem statement, data requirements, general outline of solution steps, displays of key input and output screens, and discussions of important modeling aspects.

## Overview of this Manual

This Applications Guide contains written descriptions of 24 examples that demonstrate the main features of the HEC-RAS program. The project data files for the examples are contained within the HEC-RAS program distribution Setup package, and will be written to the **HEC Data\HEC-RAS\Example Data\Applications Guide** directory when the program is installed. The discussions in this manual contain detailed descriptions for the data input and analysis of the output for each example. The examples display and describe the input and output screens used to enter the data and view the output. The user can activate the projects within the HEC-RAS program when reviewing the descriptions for the examples in this manual. All of the projects have been computed, and the user can review the input and output screens that are discussed as they appear in this manual. The user can use the zoom features and options selections (plans, profiles, variables, reaches, etc.) to obtain clearer views of the graphics, as well as viewing additional data screens that may be referenced to in the discussions. The examples are intended as a guide for performing similar analyses. This manual is organized as follows:

- **Example 1, Critical Creek**, demonstrates the procedure to perform a basic flow analysis on a single river reach. This river reach is situated on a steep slope, and the analysis was performed in a mixed flow regime to obtain solutions in both subcritical and supercritical flows. Additionally, the example describes the procedure for cross section interpolation.
- **Example 2, Beaver Creek - Single Bridge**, illustrates an analysis of a single river reach that contains a bridge crossing. The data entry for the bridge and determination for the placement of the cross sections are shown in detail. The hydraulic calculations are performed with both the energy and pressure/weir flow methods for the high flow events. Additionally, the model is calibrated with observed high flow data.
- **Example 3, Single Culvert (Multiple Identical Barrels)**, describes the data entry and review of output for a single culvert with two identical barrels. Additionally, a review for the locations of the cross sections in relation to the culvert is presented.
- **Example 4, Multiple Culverts, is a continuation of Example 3**, with the addition of a second culvert at the same cross section. The second culvert also contains two identical barrels, and this example describes the review of the output for multiple culverts.
- **Example 5, Multiple Openings**, presents the analysis of a river reach that contains a culvert opening (single culvert with multiple identical barrels), a main bridge opening, and a relief bridge opening all occurring at the same cross section. The user should be familiar with individual bridge and culvert analyses before reviewing this example.
- **Example 6, Floodway Determination**, illustrates several of the methods for floodplain encroachment analysis. An example procedure for the floodplain encroachment analysis is performed. The user should be aware of the site specific guidelines for a floodplain encroachment analysis to determine which methods and the appropriate procedures to perform.
- **Example 7, Multiple Plans**, describes the file management system used by the HEC-RAS program. The concepts of working with projects and plans to organize geometry, flow, and other files are described. Then, an application is performed to show a typical procedure for organizing a project that contains multiple plans.
- **Example 8, Looped Network**, demonstrates the analysis of a river system that contains a loop. The loop is a split in the main channel that forms two streams which join back together. The example focuses on the procedure for balancing of the flows around the loop.
- **Example 9, Mixed Flow Analysis**, describes the use of a mixed flow regime to analyze a river reach containing a bridge crossing. The bridge crossing constricts the main channel supercritical flow, creating a subcritical backwater effect, requiring the use of the mixed flow regime for the analysis. Results by subcritical and supercritical flow regime analyses are presented to show inconsistencies that developed, and to provide guidance when to perform a mixed flow analysis.
- **Example 10, Stream Junction**, demonstrates the analysis of a river system that contains a junction. This example illustrates a flow combining of two subcritical streams, and both the energy and momentum methods are used for two separate analyses.
- **Example 11, Bridge Scour**, presents the determination of a bridge scour analysis. The user should be familiar with the procedures for modeling bridges before reviewing this example. The scour equations and

procedures are based upon the methods outlined in Hydraulic Engineering Circular No. 18 (FHWA 1995).

- **Example 12, Inline Weir and Gated Spillway**, demonstrates the analysis of a river reach that contains an inline weir and a gated spillway. Procedures for entering the data to provide flexibility for the flow analysis are provided.
- **Example 13, Bogue Chitto - Single Bridge (WSPRO)**, performs an analysis of a river reach that contains a bridge crossing. The example is similar to Example 2, however, all of the water surface profiles are low flow and are computed using the WSPRO (FHWA, 1990) routines that have been adapted to the HEC-RAS methodology of cross section locations around and through a bridge.
- **Example 14, Ice-Covered River**, is an example of how to model an ice covered river as well as a river ice-jam.
- **Example 15, Split Flow Junction With Lateral Weir and Spillway**, is an example of how to perform a split flow optimization with the steady flow analysis portion of the software. This example has a split of flow at a junction, as well as a lateral weir.
- **Example 16, Channel Modification**. This example demonstrates how to use the channel modification feature within the HEC-RAS Geometric Data Editor. Channel modifications are performed, and existing and modified conditions geometry and output are compared.
- **Example 17, Unsteady Flow Application**. This example demonstrates how to perform an unsteady flow analysis with HEC-RAS. Discussions include: entering storage area information; hydraulic connections; unsteady flow data (boundary conditions and initial conditions); performing the computations; and reviewing the unsteady flow results.
- **Example 18, Advanced Inline Structure Modeling**. This example demonstrates all of the inline structure capabilities within a single structure. This includes: overflow weirs; gates; culverts; user defined rating curves; and a flow time series outlet.
- **Example 19, Hydrologic Unsteady Flow Routing – Modified Puls**. This example demonstrates how to intermix hydrologic routing in the middle of an unsteady flow model. Hydrologic routing can be used for very steep reaches where the full unsteady flow equations may not be applicable or stable.
- **Example 20, Hager’s Lateral Weir Equation**. This example demonstrates how to use Hager’s Lateral Weir equation for a Lateral Structure.
- **Example 21, Overflow Gates**. This example demonstrates how to use overflow gates in HEC-RAS.
- **Example 22, Groundwater Interflow**. This example demonstrates how to use the groundwater interflow options in HEC-RAS, within a river reach or with storage areas.
- **Example 23, Urbane Modeling**. This example demonstrates how to model pressurized pipe systems within the HEC-RAS unsteady flow modeling capabilities.
- **Example 24, Manning’s n Calibration**. This example discusses how to calibrate an unsteady flow model for base Manning’s n values, as well as how to use the HEC-RAS automated Manning’s n value calibration option.
- **Appendix A** contains a list of references.

## CHAPTER 1

# Critical Creek

## Purpose

Critical Creek is a steep river comprised of one reach entitled "Upper Reach." The purpose of this example is to demonstrate the procedure for performing a basic flow analysis on a single river reach. Additionally, the example will demonstrate the need for additional cross sections for a more accurate estimate of the energy losses and water surface elevations.

## Subcritical Flow Analysis

From the main HEC-RAS window, select **File** and then **Open Project**. Go to the directory in which you have installed the HEC-RAS example data sets. From the "Applications Guide\Chapter 1 – Critical Creek" subdirectory, select the project labeled "Critical Creek - Example 1." This will open the project and activate the following files:

Plan:	"Existing Conditions Run"
Geometry:	"Base Geometry Data"
Flow:	"100 Year Profile"

## Geometric Data

From the main program window, select **Edit** and then **Geometric Data**. This will activate the **Geometric Data Editor** and display the river system schematic, as shown in Figure 1.1. As shown in the figure, the river name was entered as "Critical Creek," and the reach name was "Upper Reach." The reach was defined with 12 cross sections numbered 12 to 1, with cross section 12 being the most upstream cross section. These cross-section identifiers are only used by the program for placement of the cross sections in a numerical order, with the highest number being the most upstream section.

The cross section data were entered in the **Cross Section Data Editor**, which is activated by selecting the **Cross Section** icon on the **Geometric Data Editor** (as outlined in Chapter 6 of the **User's Manual**). Most of the 12 cross sections contain at least 50 pairs of X-Y coordinates, so the cross section data will not be shown here for brevity. The distances between the cross sections are as shown in Figure 1.2 (The reach lengths for cross section 12 can be seen by using the scroll bars in the window.). This summary table can be viewed by selecting **Tables** and then **Reach Lengths** on the **Geometric Data Editor**.

Example 1 Critical Creek

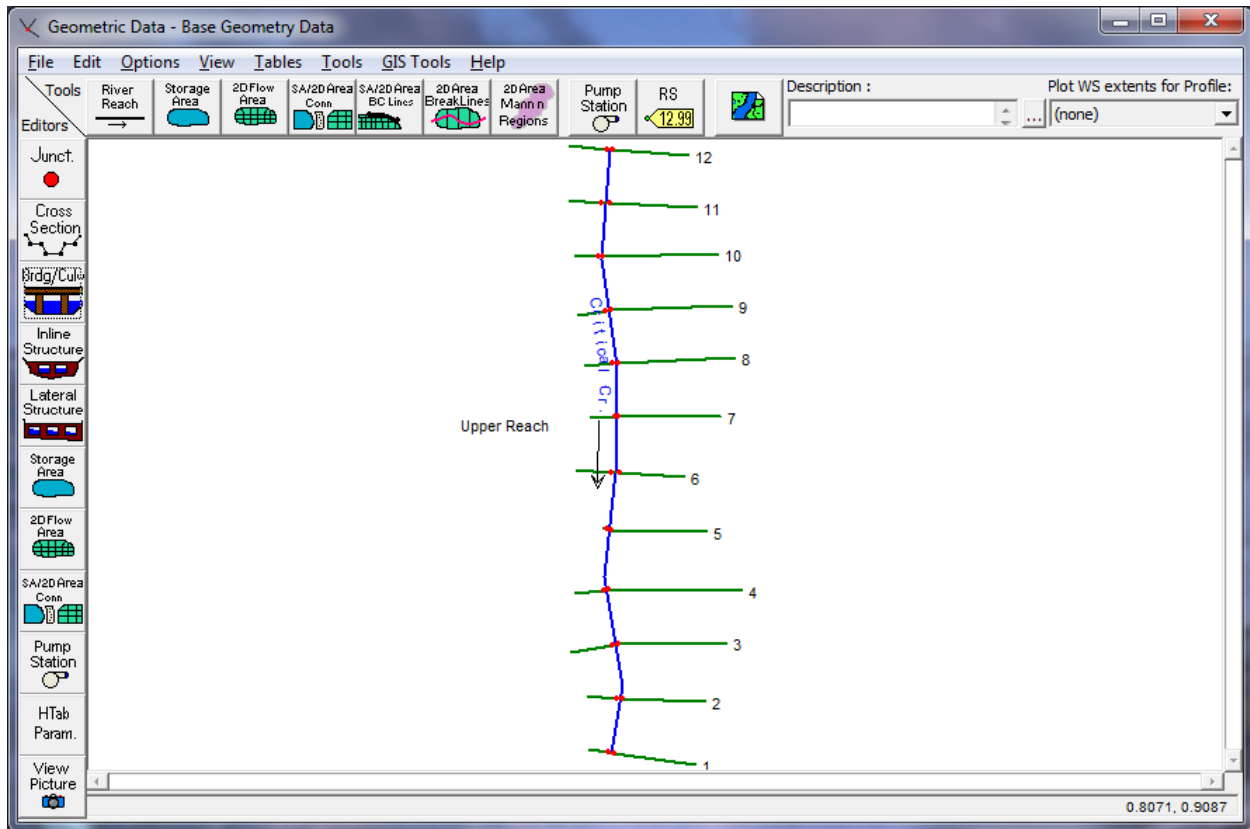

Figure 1-1: River System Schematic for Critical Creek



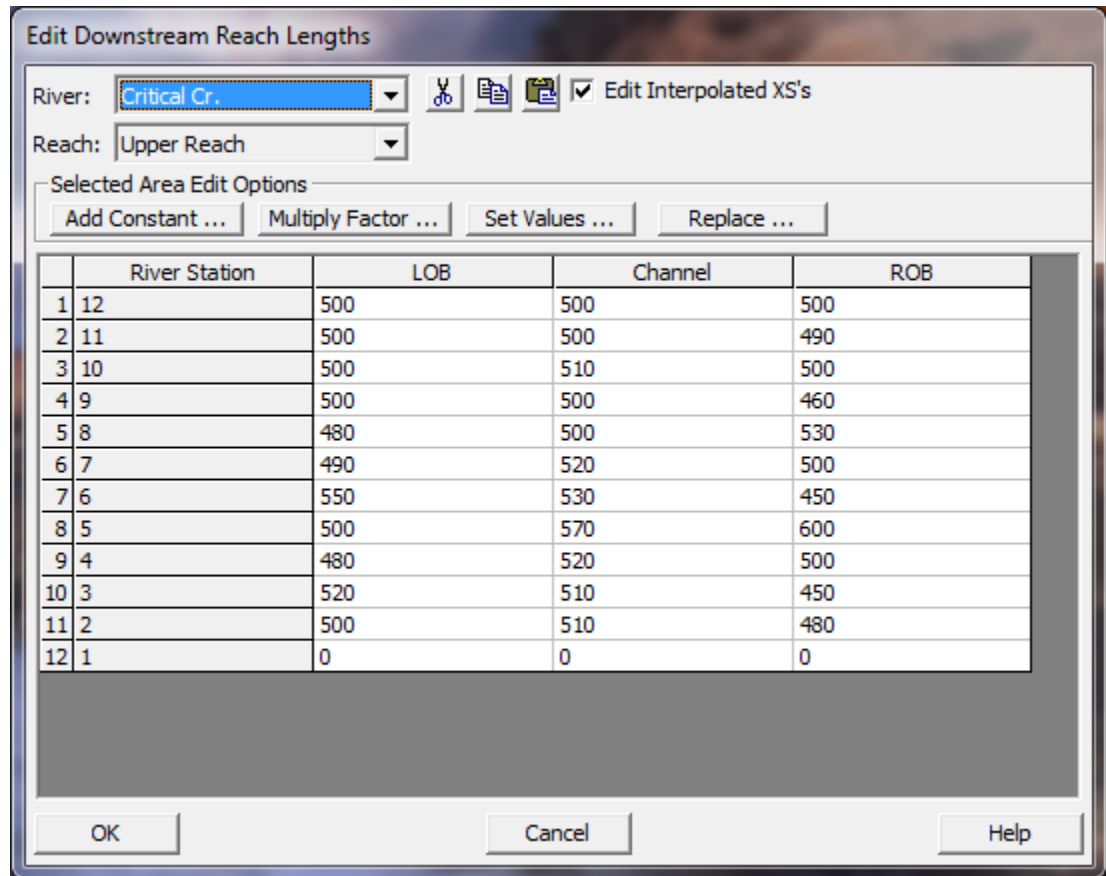

Figure 1-2: Reach Lengths For Critical Creek

From the geometric data, it can be seen that most of the cross sections are spaced approximately 500 feet apart. The change in elevation from cross section 12 to cross-section 1 is approximately 56 feet along the river reach of 5700 feet. This yields a slope of approximately 0.01 ft/ft, which can be considered as a fairly steep slope. The remaining geometric data consists of Manning's n values of 0.10, 0.04, and 0.10 in the left overbank (LOB), main channel, and right overbank (ROB), respectively. Also, the coefficients of contraction and expansion are 0.10 and 0.30, respectively. After all the geometric data was entered, it was saved as the file "Base Geometry Data."

## Flow Data

To enter the steady flow data, from the main program window **Edit** and then **Steady Flow Data** were selected. This activated the **Steady Flow Data Editor**, as shown in Figure 1.3. For this steady flow analysis, the one percent chance flow profile was analyzed. A flow of 9000 cfs was used at the upstream end of the reach at section 12 and a flow change to 9500 cfs was used at section 8 to account for a tributary inflow into the main river reach. This flow change location was entered by selecting the river, reach, river station, and then pressing the **Add A Flow Change Location** button. Then, the table in the central portion of the editor added the row for river station 8. Finally, the profile name was changed from the default heading of "PF#1" to "100 yr." The change to the profile label was made by selecting **Edit Profile Names** from the **Options** menu and typing in the new name.

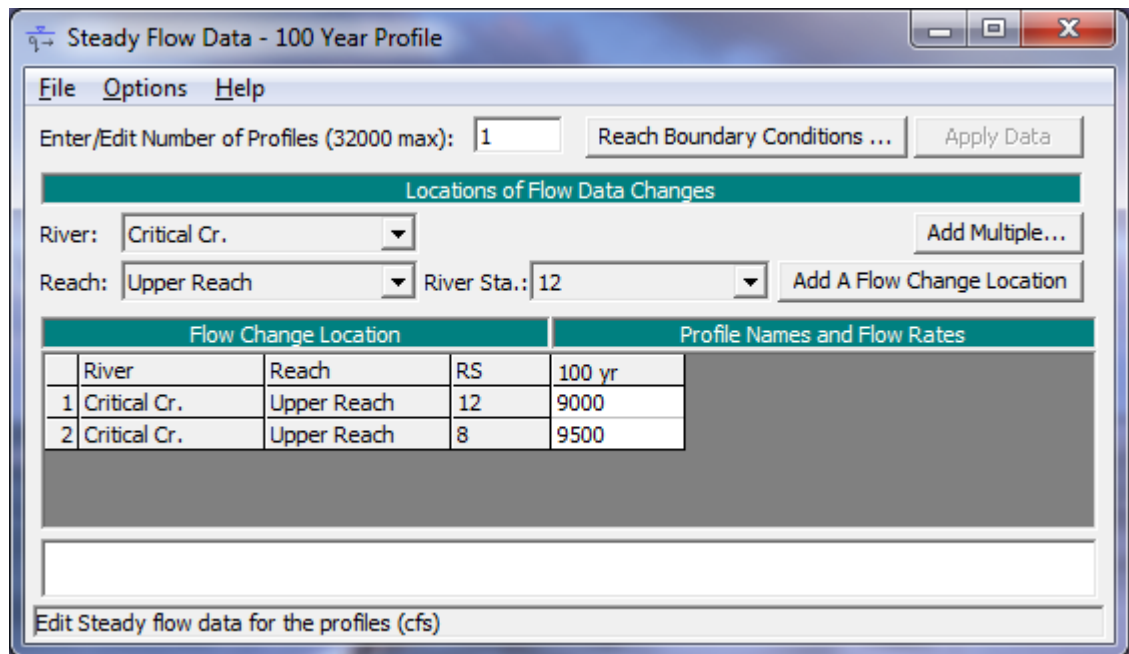

Figure 1-3: Steady Flow Data Editor

Next, the **Reach Boundary Conditions** button located at the top of the **Steady Flow Data Editor** was selected. The reach was analyzed for subcritical flow with a downstream normal depth boundary condition of  $S = 0.01$  ft/ft. This value was estimated as the average slope of the channel near the downstream boundary. For a subcritical flow analysis, boundary conditions must be set at the downstream end(s) of the river system. After all of the flow data was entered, it was saved as the file "100 Year Profile."

### Steady Flow Analysis

To perform the steady flow analysis, from the main program window Run and then **Steady Flow Analysis** were selected. This activated the **Steady Flow Analysis Window** as shown in Figure 1.4. Before performing the steady flow analysis, **Options** and then **Critical Depth Output Option** were selected. The option **Critical Always Calculated** was chosen to have critical depth calculated at all locations. This will enable the critical depth to be plotted at all locations on the profile when the results are analyzed. Next, the **Flow Regime** was selected as "Subcritical". The geometry file was selected as "Base Geometry Data," and the flow file was selected as "100 Year Profile". The plan was then saved as "Existing Conditions", with a short ID of "Exist Cond". Finally, the steady flow analysis was performed by selecting **COMPUTE** from the **Steady Flow Analysis** window.

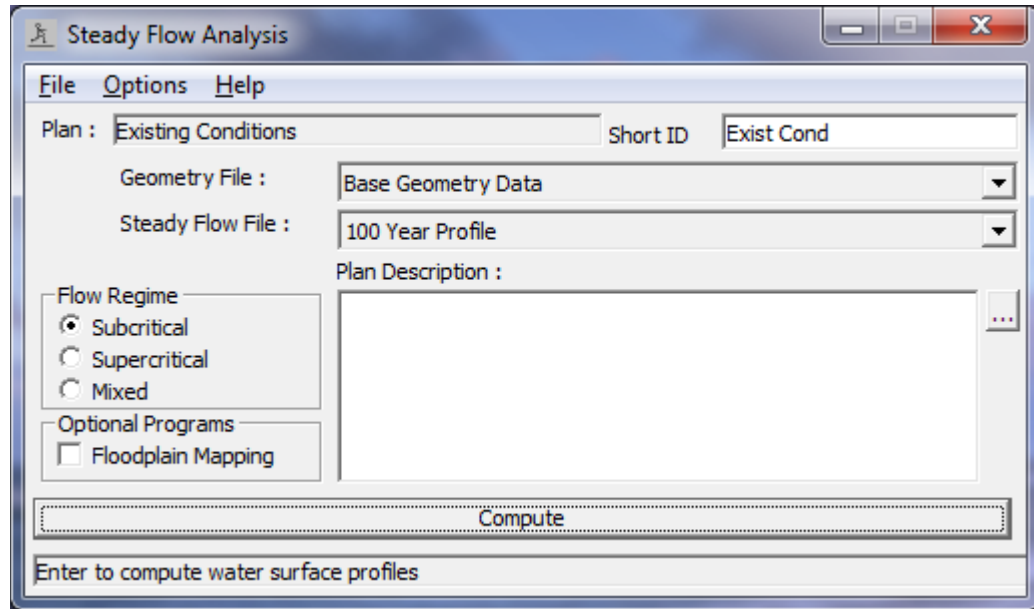

Figure 1-4: Steady Flow Analysis Window

### Subcritical Flow Output Review

As an initial view of the steady flow analysis output, from the main program window **View** and then **Water Surface Profiles** were selected. This activated the water surface profile as shown in Figure 1.5. From the **Options** menu, the **Variables** of water surface, energy, and critical depth, were chosen to be plotted.

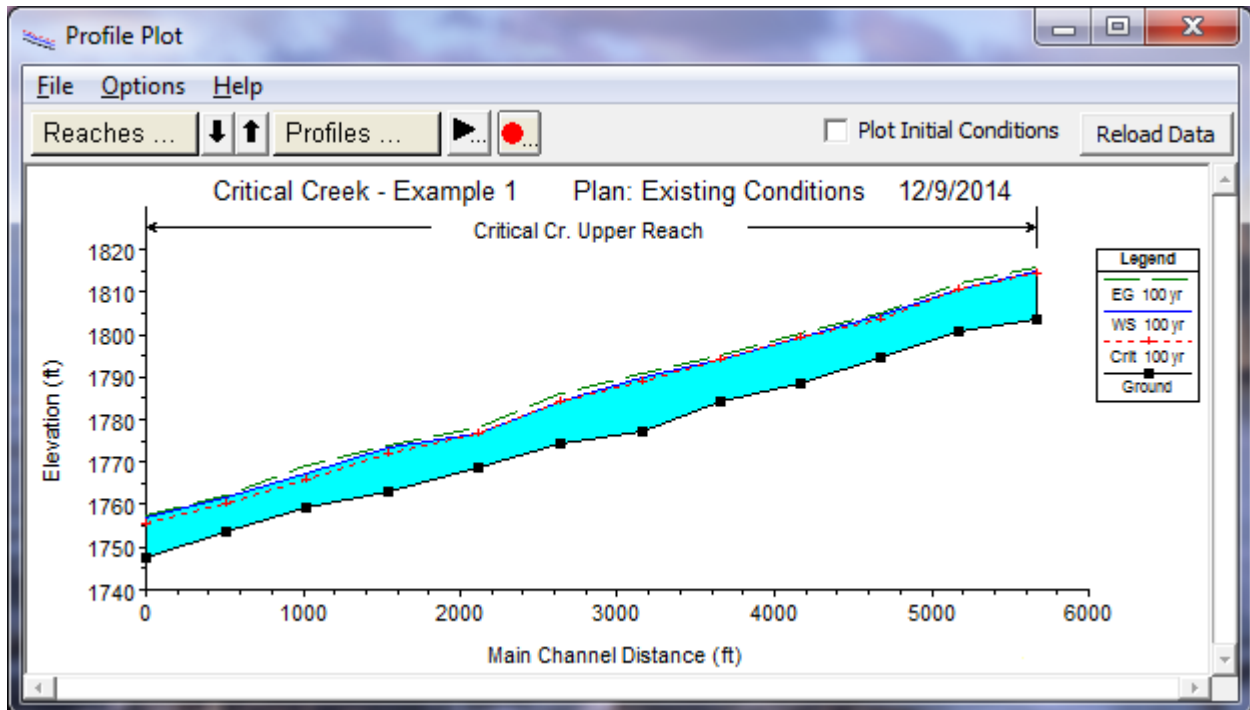

Figure 1-5: Profile Plot for Critical Creek

From this profile, it can be seen that the water surface appears to approach or is equal to the critical depth at several locations. For example, from section 12 through 8, the water surface appears to coincide with the critical depth. This implies that the program may have had some difficulty in determining a subcritical flow value in this region, or perhaps the actual value of the flow depth is in the supercritical flow regime. To investigate this further, a closer review of the output needs to be performed. This can be accomplished by reviewing the output at each of the cross sections in either graphical or tabular form, and by viewing the summary of **Errors, Warnings and Notes**.

First, a review of the output at each cross section will be performed. From the main program window, select **View, Detailed Output Tables, Type**, and then **Cross Section**. Selection of cross section 12 should result in the display as shown in Figure 1.6. At the bottom of the table is a box that displays any errors, warnings, or notes that are specific to that cross section. For this example, there are several warning messages at cross section 12. The first warning is that the velocity head has changed by more than 0.5 feet and that this may indicate the need for additional cross sections. To explain this message, it is important to remember that for a subcritical flow analysis, the program starts at the downstream end of the reach and works upstream. After the program computed the water surface elevation for the 11th cross section, it moved to the 12th cross section. When the program computed the water surface elevation for the 12th cross section, the difference in the velocity head from the 11th to the 12th cross section was greater than 0.5 feet. This implies that there was a significant change in the average velocity from section 11 to section 12. This change in velocity could be reflecting the fact that the shape of the cross section is changing dramatically and causing the flow area to be contracting or expanding, or that a significant change in slope occurred. In order to model this change more effectively, additional cross sections should be supplied in the region of the contraction or expansion. This will allow the program to better calculate the energy losses in this region and compute a more accurate water surface profile.

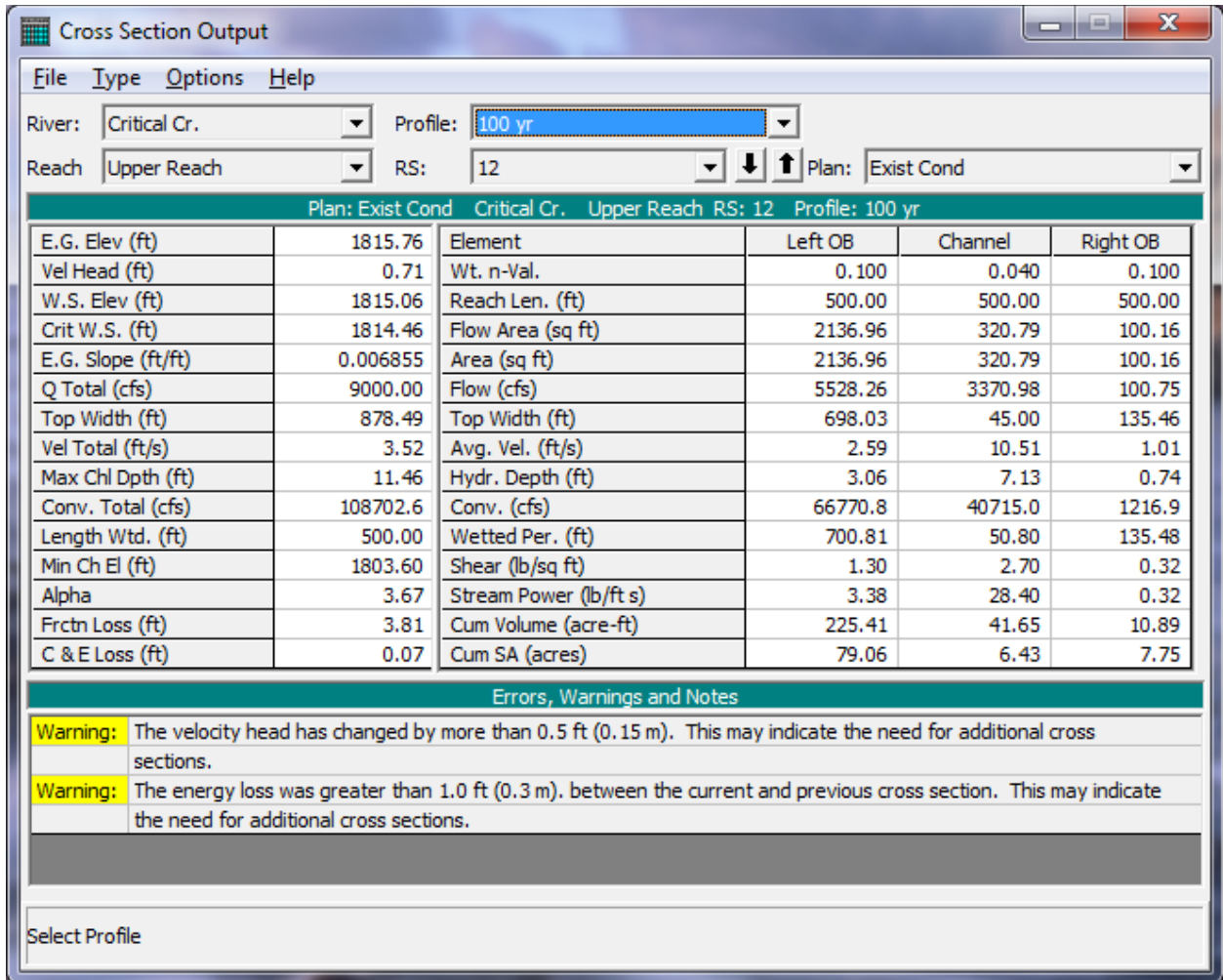

Figure 1-6: Cross Section Table For River Station 12

The second warning at cross section 12 states that the energy loss was greater than 1.0 feet between the current cross section (#12) and the previous cross section (#11). This warning also indicates the possible need for additional cross sections. This is due to the fact that the rate of energy loss is usually not linear. However, the program uses, as a default, an average conveyance equation to determine the energy losses. Therefore, if the cross sections are too far apart, an appropriate energy loss will not be determined between the two cross sections. (The user may select alternate methods to compute the average friction slope. Further discussion of user specified friction loss formulation is discussed in Chapter 4 of the **Hydraulic Reference Manual**.)

A review of other cross sections reveals the same and additional warnings. To review the errors, notes, and warnings for all of the cross sections, select **Summary Errors, Warnings, and Notes** from the **View** menu on the main program window. A portion of the summary table is shown in Figure 1.7.

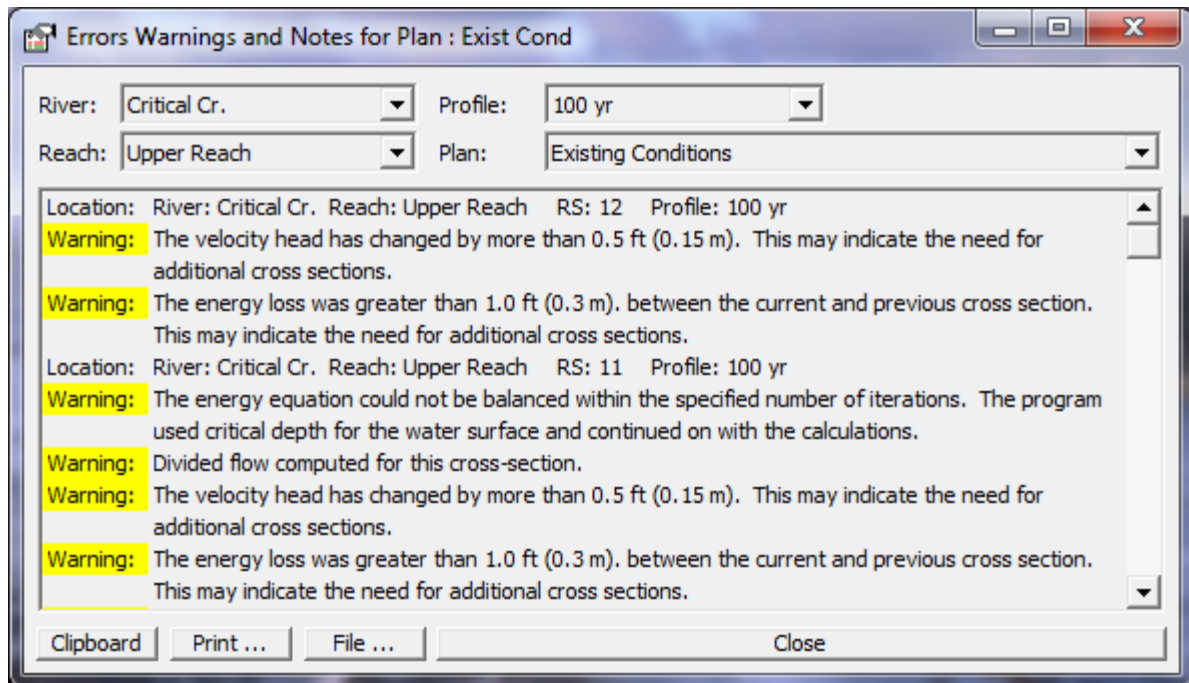

Figure 1-7: Summary of Warnings and Notes for Critical Creek

The additional warnings and notes that are listed in the summary table are described as follows.

- Warning - The energy equation could not be balanced within the specified number of iterations. The program used critical depth for the water surface and continued on with the calculations. This warning implies that during the computation of the upstream water surface elevation, the program could not compute enough energy losses to provide for a subcritical flow depth at the upstream cross section. Therefore, the program defaulted to critical depth and continued on with the analysis.
- Warning - Divided flow computed for this cross-section. After the flow depth was calculated for the cross section, the program determined that the flow was occurring in more than one portion of the cross section. For example, this warning occurred at river station # 10 and the plot of this cross section is shown in Figure 1.8. From the figure, it can be seen that at approximately an X-coordinate of 800, there exists a large vertical land mass. During this output analysis, it must be determined whether or not the water can actually be flowing on both sides of the land mass at this flow rate. Since the main channel is on the right side of the central land mass, could the water be flowing on the left side or should all of the flow be contained to the right side of the land mass? By default, the program will consider that the water can flow on both sides of the land mass. If this is not correct, then the modeler needs to take additional action.

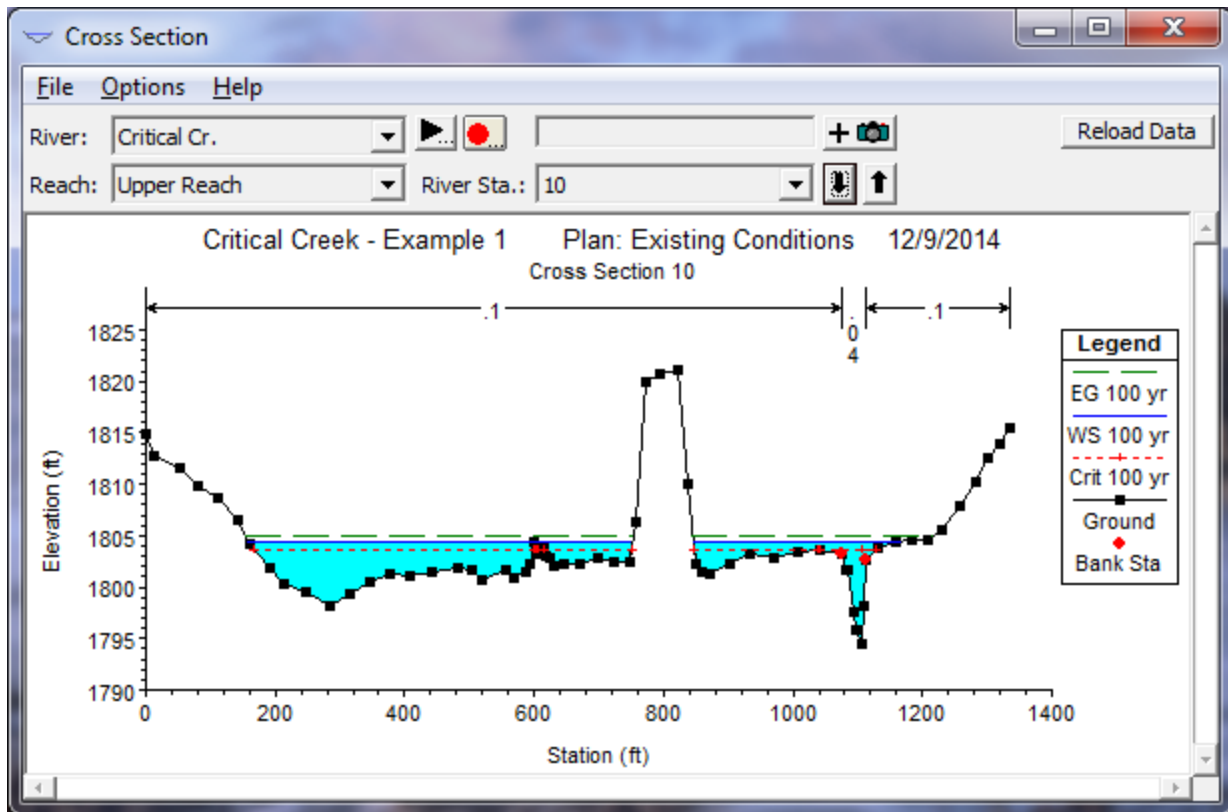

Figure 1-8: Cross Section 10, Showing Divided Flow

Additional action can be one of two procedures. First, if the existing scenario is not feasible, then the water on the left side may be considered as an ineffective flow area, where the water is accounted for volumetrically but it is not considered in the conveyance determination until a maximum elevation is reached. Secondly, if all of the flow should be occurring only on the right side of the land mass, then the land mass could be considered as a levee. By defining the central vertical land mass as a levee, the program will not permit a flow onto the left side of the levee until the flow depth overtops the levee.

For further discussion on ineffective flow areas and levees, refer to Chapter 6 of the **User's Manual** and Chapter 3 of the **Hydraulic Reference Manual**.

- Warning - During the standard step iterations, when the assumed water surface was set equal to critical depth, the calculated water surface came back below critical depth. This indicates that there is not a valid subcritical answer. The program defaulted to critical depth. This warning is issued when a subcritical flow analysis is being performed but the program could not determine a subcritical flow depth at the specified cross section. As the program is attempting to determine the upstream depth, it is using an iterative technique to solve the energy equation. During the iterations, the program tried critical depth as a possible solution, which resulted in a flow depth less than critical. Since this is not possible in a subcritical analysis, the program defaulted to using critical depth at this cross section and continued on with the analysis. This error is often associated with too long of a reach length between cross sections or misrepresentation of the effective flow area of the cross section.
- Warning - The parabolic search method failed to converge on critical depth. The program will try the cross section slice/secant method to find

critical depth. This message appears if the program was required to calculate the critical depth and had difficulty in determining the critical depth at the cross section. The program has two methods for determining critical depth: a parabolic method and a secant method. The parabolic method is the default method (this can be changed by the user) because this method is faster and most cross sections have only one minimum energy point. However, for cross sections with large, flat over banks, there can exist more than one minimum energy point. For further discussion, refer to the section Critical Depth Determination in Chapter 2 of the Hydraulic Reference Manual.

- Note - Multiple critical depths were found at this location. The critical depth with the lowest, valid, water surface was used. This note appears when the program was required to determine the critical depth and accompanies the use of the secant method in the determination of the critical depth (as described in the previous warning message). This note prompts the user to examine closer the critical depth that was determined to ensure that the program supplied a valid answer. For further discussion, refer to the section Critical Depth Determination in Chapter 2 of the Hydraulic Reference Manual.
- Warning - The conveyance ratio (upstream conveyance divided by downstream conveyance) is less than 0.7 or greater than 1.4. This may indicate the need for additional cross sections. The conveyance of the cross section,  $K$ , is defined by:

$$K = \frac{1.486}{n} AR^{2/3} \quad (1-1)$$

If the  $n$  values for two subsequent cross sections are approximately the same, it can be seen that the ratio of the two conveyances is primarily a function of the cross sectional area. If this ratio differs by more than 30%, then this warning will be issued. This warning implies that the cross sectional areas are changing dramatically between the two sections and additional cross sections should be supplied for the program to be able to more accurately compute the water surface elevation.

In summary, these warnings and notes are intended to inform the user that potential problems may exist at the specified cross sections. It is important to note that the user does not have to eliminate all the warning messages. However, it is up to the user to determine whether or not these warnings require additional action for the analysis.

## Mixed Flow Analysis

Upon reviewing the profile plot and the summary of errors, warnings, and notes from the subcritical flow analysis, it was determined that additional cross-section information was required. Additionally, since the program defaulted to critical depth at various locations along the river reach and could not provide a subcritical answer at several locations, a subsequent analysis in the mixed flow regime was performed. A mixed flow analysis will provide results in both the subcritical and supercritical flow regimes.



## Modification of Existing Geometry

Before performing the mixed flow regime analysis, the existing geometry was modified by adding additional cross sections. To obtain the additional cross section information, the modeler should use surveyed cross section data whenever possible. If this data are not available, then the cross section interpolation method within the HEC-RAS program can be used. However, this method is not intended to be a replacement for actual field data. The modeler should review all interpolated cross sections because they are based on a linear transition between the input sections. Whenever possible, use topographic maps for assistance in evaluating whether or not the interpolated cross sections are adequate. The modeler is referred to the discussions in Chapter 6 of the **User's Manual** and Chapter 4 of the **Hydraulic Reference Manual** for additional information on cross section interpolation.

To obtain additional cross sections for this example, the interpolation routines were used. From the **Geometric Data Editor, Tools** and then **XS Interpolation** was selected. The initial type of interpolation was **Within a Reach**. The interpolation was started at cross section 12 and ended at cross section 1. The maximum distance was set to be 150 feet (This value can be changed later by the modeler to develop any number of cross sections desired.). Finally, **Interpolate XS's** was selected. When the computations were completed, the window was closed. At this point, the modeler can view each cross-section individually or the interpolated sections can be viewed between the original sections. The latter option is accomplished by selecting **Tools, XS Interpolation**, and then **Between 2 Xs's**. The up and down arrows are used to toggle up and down the river reach, while viewing the interpolated cross sections. When the upper river station is selected to be 11 (the lower station will automatically be 10), the interpolation shown in Figure 1.9 should appear.

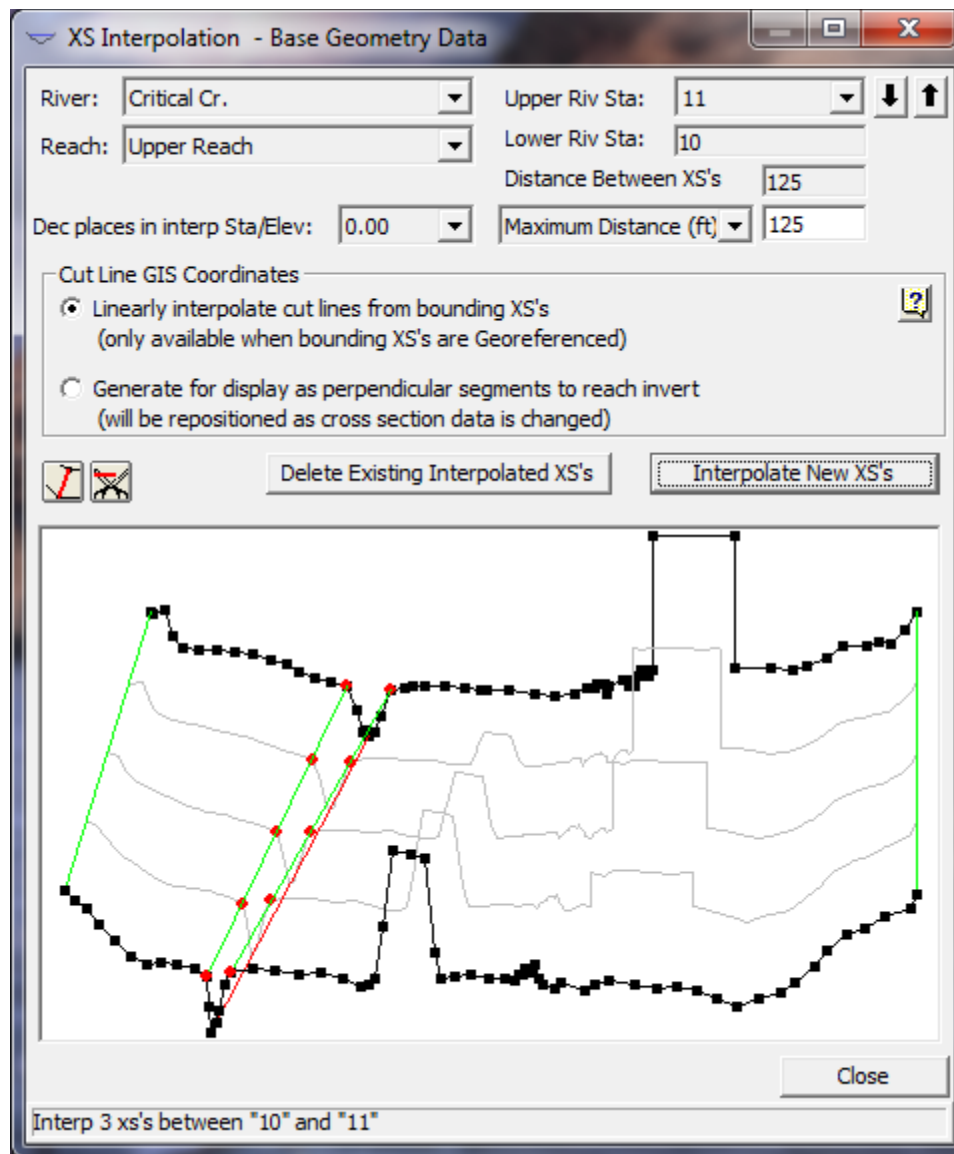

Figure 1-9: Cross Section Interpolation Based on Default Master Cords

As shown in Figure 1.9, the interpolation was adequate for the right overbank and the main channel. However, the interpolation in the left overbank failed to connect the two existing high ground areas. These two high ground areas could be representing a levee or some natural existing feature. Therefore, Del Interp was selected to delete the interpolation. (This only deleted the interpolation between cross sections 11 and 10.) Then, the two high points and the low points of the high ground areas were connected with user supplied master cords. This was accomplished by selecting the Master Cord button and connecting the points where the master cords should be located. Finally, a maximum distance of 150 feet was entered between cross sections and Interpolate was selected. The final interpolation appeared as is shown in Figure 1.10.

The modeler should now go through all of the interpolated cross sections and determine that the interpolation procedure adequately produced cross sections that depict the actual geometry. When completed, the geometric

data was saved as the new file name "Base Geometry + Interpolated." This allowed the original data to be unaltered and available for future reference.

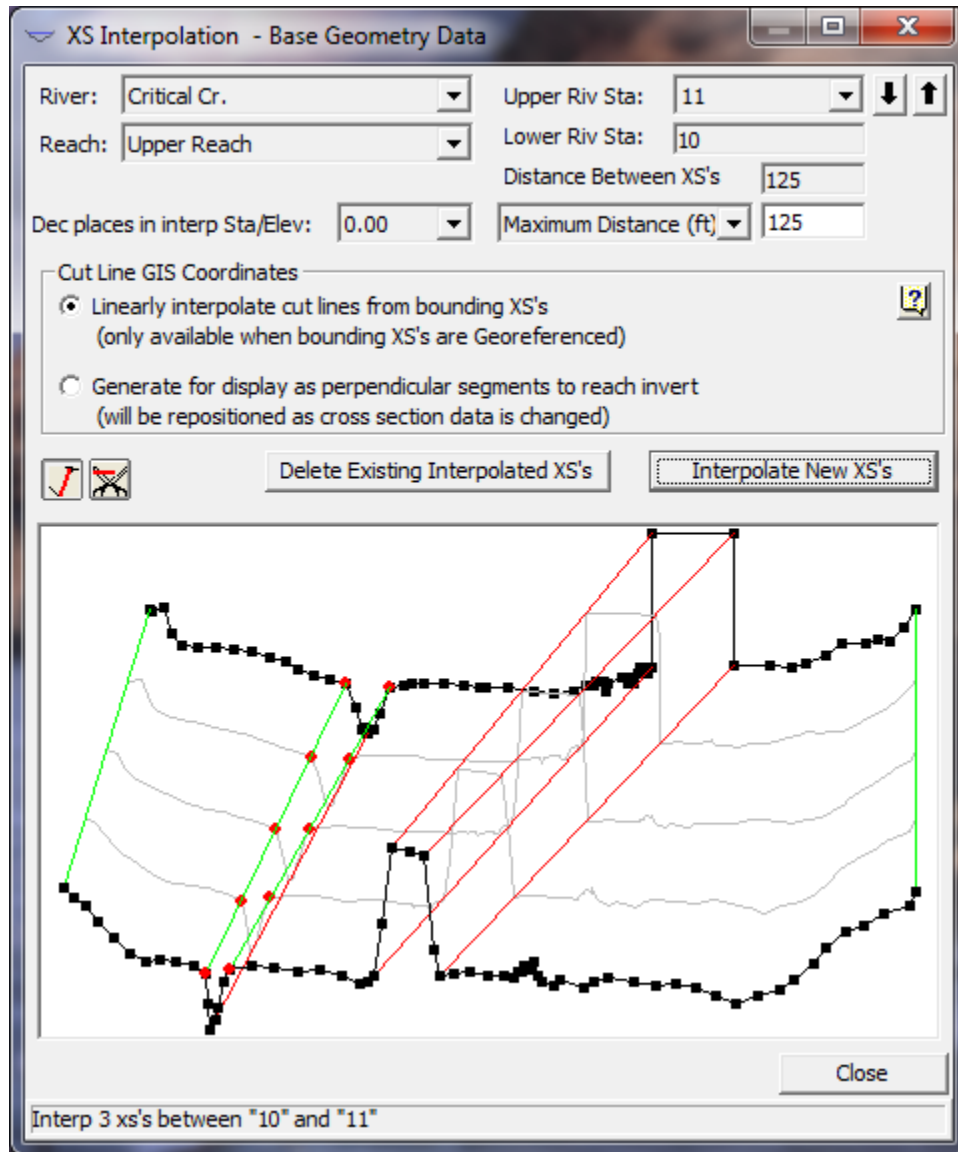

Figure 1-10: Final Interpolated With Additional Master Cords

## Flow Data

At this point, with the additional cross sections, the modeler can perform a flow analysis with subcritical flow as was performed previously and compare the results with the previously obtained data. However, for the purposes of this example, an upstream boundary condition was added and then a mixed flow regime analysis was performed. Since a mixed flow analysis (subcritical and supercritical flow possibilities) was selected, an upstream boundary condition was required. From the main program window, **Edit** and then **Steady Flow Data** were selected. Then the **Boundary Conditions** button was chosen and a normal depth boundary condition was entered at the upstream end of the reach. A slope of 0.01 ft/ft as the approximate slope of the channel at section 12 was used. Finally, the flow data was saved as a

new file name. This will allow the modeler to recall the original data when necessary. For this example, the new flow data file was called "100 YR Profile - Up and Down Bndry." that includes the changes previously mentioned.

### **Mixed Flow Analysis**

To perform the mixed flow analysis, from the main program window Run and **Steady Flow Analysis** were selected. The flow regime was selected to be "Mixed," the geometry file was chosen as "Base Geometry + Interpolated," and the steady flow file as "100 YR Profile - Up and Down Bndry." The Short ID was entered as "Modified Geo," and then File and Save Plan As were selected and a new name for this plan was entered as "Modified Geometry Conditions". This plan will then associate the geometry, flow data, and output file for the changes that were made. Finally, COMPUTE was selected to perform the steady flow analysis.

### **Review of Mixed Flow Output**

As before, the modeler needs to review all of the output, which includes the profile as well as the channel cross sections both graphically and in tabular form. Also, the list of errors, warning, and notes should be reviewed. The modeler then needs to determine whether additional action needs to be taken to perform a subsequent analysis. For example, additional cross sections may still need to be provided between sections in the reach. The modeler may also consider to use additional flow profiles during the next analysis. The modeler should review all of the output data and make changes where they are deemed appropriate.

For this analysis, the resulting profile plot is shown in Figure 1.11. From this figure, it can be seen that the flow depths occur in both the subcritical and supercritical flow regimes. (The user can use the zoom feature under the **Options** menu in the program. This can imply that the geometry of the river reach and the selected flows are producing subcritical and supercritical flow results for the reach.

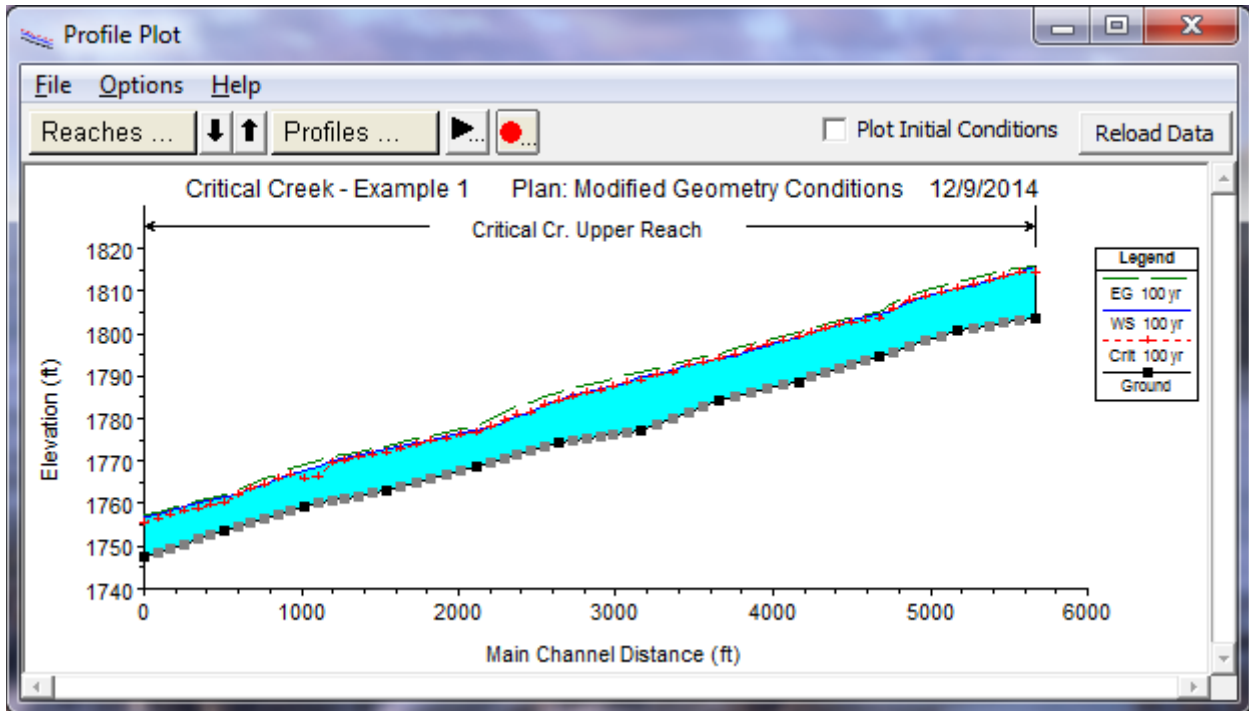

Figure 1-11: Profile Plot for Critical Creek – Mixed Flow Analysis

To investigate this further, the results will be viewed in tabular form. From the main program window, **View, Profile Summary Tables, Std. Tables**, and then **Standard Table 1** were selected. This table for the mixed flow analysis is shown as Figure 1.12. The table columns show the default settings of river, reach, river station, total flow, minimum channel elevation, water surface elevation, etc. The meanings of the headings are described in a box at the bottom of the table. By selecting a cell in any column, the definition of the heading will appear in the box for that column.

From the **Standard Table 1**, the water surface elevations and critical water surface elevations can be compared. The values at river station 11.2\* show that the flow is supercritical at this cross section since the water surface is at an elevation of 1811.29 ft and the critical water surface elevation is 1811.46 ft. Additionally, it can be seen that the flow at river station 11.0 is subcritical. (Note: the asterisks (\*) denote that the cross sections were interpolated.) By selecting the **Cross Section** type table (as performed for Figure 1.6), and toggling to river station 11.0, a note appears at the bottom of the table indicating that a hydraulic jump occurred between this cross section and the previous upstream cross section. These results are showing that the flow is both subcritical and supercritical in this reach. The user can continue this process of reviewing the warnings, notes, profile plot, profile tables, and cross section tables to determine if additional cross sections are required.

Example 1 Critical Creek

Reach	River Sta	Profile	Q Total (cfs)	Min Ch El (ft)	W.S. Elev (ft)	Crit W.S. (ft)	E.G. Elev (ft)	E.G. Slope (ft/ft)	Vel Chnl (ft/s)	Flow Area (sq ft)	Top Width (ft)	Froude # Chl
Upper Reach	12	100 yr	9000.00	1803.60	1815.61	1814.30	1815.94	0.003284	7.65	3060.26	917.39	0.49
Upper Reach	11.8*	100 yr	9000.00	1803.02	1814.57	1814.14	1815.44	0.006453	10.79	2401.95	817.24	0.69
Upper Reach	11.6*	100 yr	9000.00	1802.44	1813.40	1813.40	1814.67	0.008380	12.14	2044.30	764.56	0.80
Upper Reach	11.4*	100 yr	9000.00	1801.86	1812.43	1812.48	1813.82	0.008533	12.25	1894.08	698.93	0.81
Upper Reach	11.2*	100 yr	9000.00	1801.28	1811.29	1811.46	1812.90	0.009619	12.73	1701.29	646.22	0.86
Upper Reach	11	100 yr	9000.00	1800.70	1810.67	1810.42	1811.90	0.007059	11.21	1886.54	649.64	0.75
Upper Reach	10.800*	100 yr	9000.00	1799.44	1809.72	1809.72	1811.11	0.008368	12.10	1853.57	701.59	0.81
Upper Reach	10.600*	100 yr	9000.00	1798.18	1808.65	1808.93	1810.18	0.010182	13.06	1906.42	827.68	0.88
Upper Reach	10.400*	100 yr	9000.00	1796.92	1807.14	1807.66	1808.94	0.014963	14.73	1843.63	854.45	1.04
Upper Reach	10.200*	100 yr	9000.00	1795.66	1805.44	1805.91	1807.16	0.021176	15.71	1762.58	861.98	1.19
Upper Reach	10	100 yr	9000.00	1794.40	1804.63	1803.69	1805.08	0.008684	9.84	2636.08	960.38	0.73
Upper Reach	9.833333*	100 yr	9000.00	1793.45	1803.79	1803.09	1804.34	0.008689	10.48	2624.10	975.48	0.76
Upper Reach	9.666666*	100 yr	9000.00	1792.50	1802.94	1802.59	1803.60	0.008747	10.99	2609.34	997.03	0.78
Upper Reach	9.5*	100 yr	9000.00	1791.55	1802.10	1801.91	1802.85	0.008814	11.36	2607.14	1032.99	0.79
Upper Reach	9.333333*	100 yr	9000.00	1790.60	1801.18	1801.18	1802.07	0.009426	11.90	2566.50	1091.69	0.82

Total flow in cross section.

Figure 1-12: Standard Table 1 for Mixed Flow Analysis – Critical Creek

## Summary

Initially, the river reach was analyzed using the existing geometric data and a subcritical flow regime. Upon analysis of the results, it was determined that additional cross-section data were needed and that there might be supercritical flow within the reach. Additional cross sections were then added by interpolation and the reach was subsequently analyzed using the mixed flow regime method. Review of the mixed flow analysis output showed the existence of both subcritical and supercritical flow within the reach. This exhibits that the river reach is set on a slope that will produce a water surface around the critical depth for the given flow and cross section data. Therefore, a completely subcritical or supercritical profile is not possible.

## CHAPTER 2

# Beaver Creek - Single Bridge

## Purpose

This example demonstrates the use of HEC-RAS to analyze a river reach that contains a single bridge crossing. For this example, the bridge is composed of typical geometry and was located perpendicular to the direction of flow in the main channel.

The stream for this example is a section of Beaver Creek located near Kentwood, Louisiana. The bridge crossing is located along State Highway 1049, near the middle of the river reach. The field data for this example were obtained from the United States Geological Survey (USGS) Hydrologic Atlas No. HA-601. This atlas is one part of a series developed to provide data to support hydraulic modeling of flow at highway crossings in complex hydrologic and geographic settings. The bridge, cross section geometry, and high water flow data were used to evaluate the flood flow of 14000 cfs that occurred on May 22, 1974, along with analysis of two additional flow values of 10000 cfs and 5000 cfs. It should be noted that modelers typically do not have access to high water marks and actual field flow measurements at bridges during the peak events. However, for this example, the flood stage water depth values were compared to the output from the model.

For this analysis, the water surface profiles were determined by first using the pressure/weir flow method and then the energy method. Next, an evaluation of the bridge contraction and expansion reach lengths was performed and resulted in the necessity to reposition the location of certain cross sections. After these adjustments were made, the model was then calibrated with the observed water surface elevation data. Finally, a comparison of the pressure/weir flow method to the energy method was made.

## Pressure/Weir Flow Analysis

From the main HEC-RAS window, select **File** and then **Open Project**. Go to the directory in which you have installed the example data sets. From the "Applications Guide\Chapter 2 – Beaver Creek" subdirectory, select the project labeled "Single Bridge - Example 2." This will open the project and activate the following files:

Plan :	"Pressure/Weir Method"
Geometry :	"Beaver Cr. + Bridge - P/W"
Flow :	"Beaver Cr. - 3 Flows"

To perform the pressure/weir flow analysis, the following data were entered:

## Example 2 Beaver Creek – Single Bridge

- River System Schematic
- Cross Section Geometric Data
- Bridge Geometry Data
- Ineffective Flow Areas
- Bridge Modeling Approach
- Steady Flow Data

After the input of this data, the pressure/weir flow method was used to determine the resulting water surface elevations for the selected flow values.

### River System Schematic

From the main program window, select **Edit** and then **Geometric Data**. This will activate the **Geometric Data Editor** and the screen will display the river system schematic for the Beaver Creek reach, as shown in Figure 2.1. The river name was entered as "Beaver Creek" and the reach name was "Kentwood."

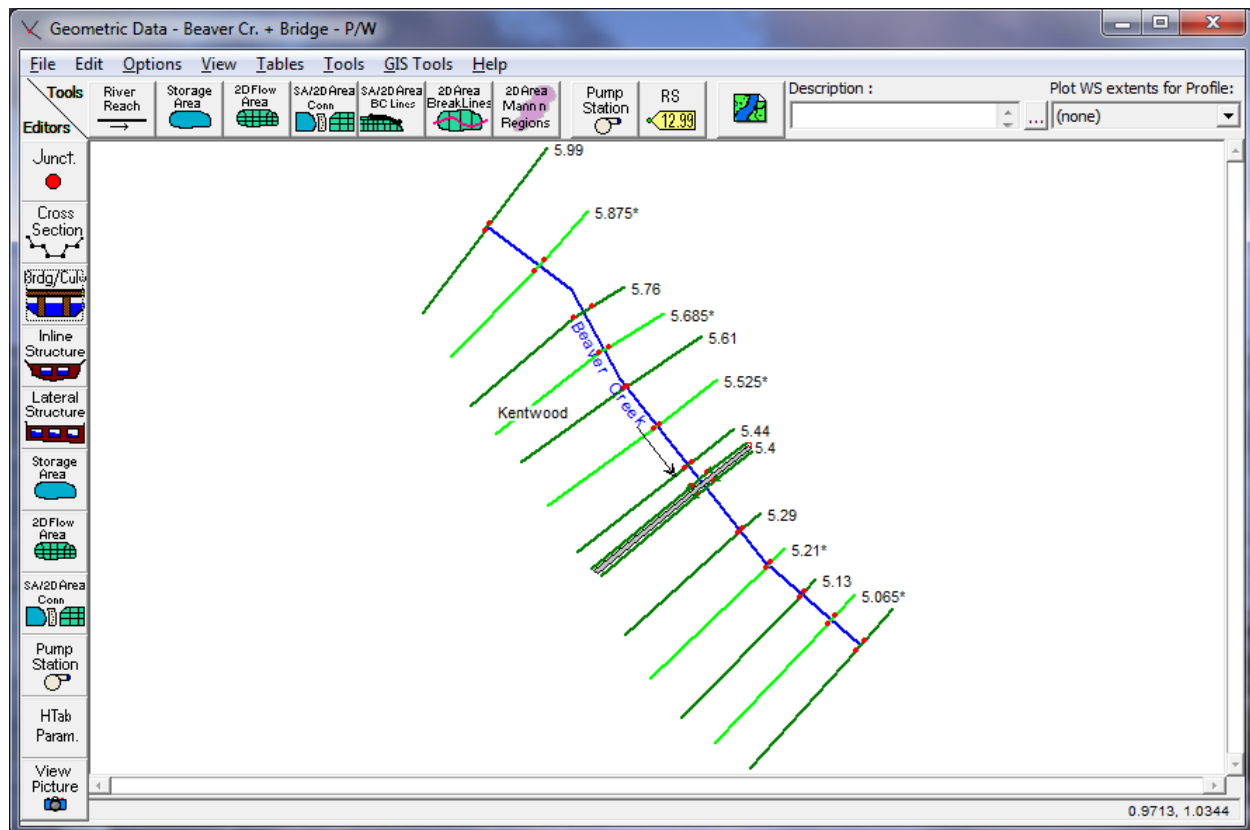

Figure 2-1: River System Schematic for Beaver Creek

The reach was initially defined with 14 cross sections beginning at river mile 5.00 as the downstream river station and river mile 5.99 as the upstream river station. The cross sections with an asterisk (\*) were added by interpolation for the purposes of this example. When the bridge was added, it was placed at river mile 5.40 to place it at the appropriate location. On the river schematic, some of the cross section labels may not appear due to overlapping of the labels. If this occurs, the labels can be seen by zooming in on the location of the closely spaced cross sections.



## Cross Section Geometric Data

The cross section geometric data consists of the: X-Y coordinates, reach lengths, Manning's n values, location of levees, and contraction and expansion coefficients. Each of these river station geometric data components are described in the following sections.

**X-Y Coordinates.** To view the cross section geometry data, from the **Geometric Data Editor** select the **Cross Section** icon. This will activate the **Cross Section Data Editor** as shown in Figure 2.2 for river mile 5.99. As shown in Figure 2.2, the X-Y coordinates were entered in the table on the left side of the editor. The additional components of the cross section geometry are described in the following sections.

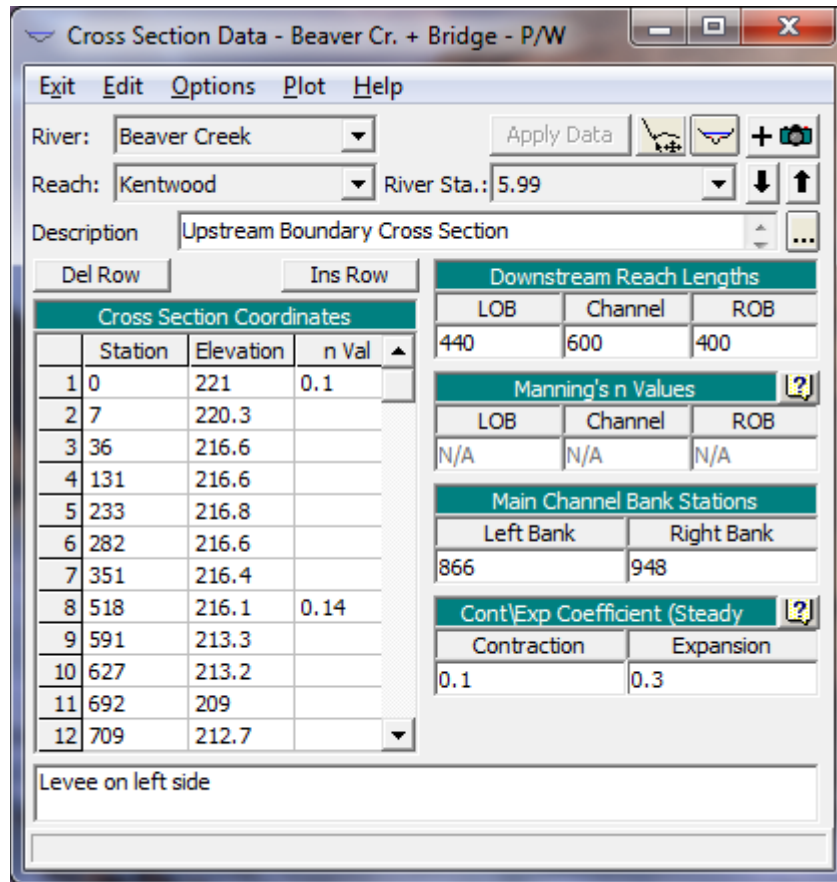

Figure 2-2: Cross Section Data Editor For River Station 5.99

**Reach Lengths.** The distances between the cross sections are entered as the downstream reach lengths in the **Cross Section Data Editor**. To view the summary of the reach lengths, the table as shown in Figure 2.3 can be activated by selecting **Tables** and then **Reach Lengths** from the **Geometric Data Editor**. The reach lengths were obtained by measuring the distances on the USGS atlas. To determine the main channel distances, it was initially assumed that during the peak event, the major active portion of the flow will follow the course of the main channel. If, after the analysis, it is determined that the major portion of the active flow is not following the main channel course, then the main channel flow distances will need to be adjusted. In

other words, if the major portion of the active flow is "cutting across" the meanders of the main channel, then these reach lengths will need to be reevaluated.

The screenshot shows a software dialog box titled "Edit Downstream Reach Lengths". At the top, there are dropdown menus for "River:" (Beaver Creek) and "Reach:" (Kentwood). To the right of the "River:" dropdown are icons for undo, copy, and paste, and a checked checkbox for "Edit Interpolated XS's". Below these are "Selected Area Edit Options" with buttons for "Add Constant ...", "Multiply Factor ...", "Set Values ...", and "Replace ...". The main part of the dialog is a table with the following data:

	River Station	LOB	Channel	ROB
1	5.99	440	600	400
2	5.875*	440	600	400
3	5.76	225	400	275
4	5.685*	225	400	275
5	5.61	240	460	190
6	5.525*	240	460	190
7	5.44	270	170	500
8	5.41	100	100	100
9	5.4 Highway 1049	Bridge		
10	5.39	320	500	580
11	5.29	410	416.5	410
12	5.21*	410	416.5	410

At the bottom of the dialog are "OK", "Cancel", and "Help" buttons.

Figure 2-3: Reach Lengths Summary Table

The reach lengths determine the placement of the cross sections. The placement of the cross sections relative to the location of the bridge is crucial for accurate prediction of expansion and contraction losses. The bridge routine utilizes four cross sections to determine the energy losses through the bridge. (Additionally the program will interpret two cross sections inside of the bridge by superimposing the bridge data onto both the immediate downstream and upstream cross sections from the bridge.) The following is a brief summary for the initial estimation of the placement of the four cross sections. The modeler should review the discussion in Chapter 6 of the **User's Manual** and Chapter 5 of the **Hydraulic Reference Manual** for further detail.

**First Cross Section.** Ideally, the first cross section should be located sufficiently downstream from the bridge so that the flow is not affected by the structure (ie, the flow has fully expanded). This distance should generally be determined by field investigation during high flows and will vary depending on the degree of constriction, the shape of the constriction, the magnitude of the flow, and the velocity of the flow. In order to provide better guidance to determine the location of the fully expanded cross section, a study was performed by the Hydrologic Engineering Center [HEC-1995]. This study focused on determining the expansion reach length, the contraction reach length, and the expansion and contraction energy loss coefficients.

For this example, cross section number 5.29 was initially considered as the cross section of fully expanded flow. This cross section was determined by field investigations as the approximate location of fully expanded flow during the high flow event. After the pressure/weir flow analysis was performed, the

location of this cross section was evaluated using the procedures as outlined in the recent HEC study [HEC-1995]. The procedures required flow parameters at the initially chosen location to evaluate the location of the cross section. These procedures will be described after the pressure/weir flow analysis is performed near the end of this example.

Second Cross Section. The second cross section used by the program to determine the energy losses through the bridge is located a short distance downstream of the structure. This section should be very close to the bridge, and reflect the effective flow area on the downstream side of the bridge. For this example, a roadway embankment sloped gradually from the roadway decking on both sides of the roadway. Cross section 5.39 was located at the toe of the roadway embankment and was used to represent the effective flow area on the downstream side of the bridge opening. The program will superimpose the bridge geometry onto this cross section to develop a cross section inside the bridge at the downstream end.

Third Cross Section. The third cross section is located a short distance upstream from the bridge and should reflect the length required for the abrupt acceleration and contraction of the flow that occurs in the immediate area of the opening. As for the previous cross section, this cross section should also exhibit the effective flow areas on the upstream side of the bridge. For this example, cross section 5.41 was located at the toe of the roadway embankment on the upstream side of the bridge. Similar to the previous cross section, the program will superimpose the bridge geometry onto this cross section to develop a cross section inside the bridge at the upstream end.

Fourth Cross Section. The fourth cross section is located upstream from the bridge where the flow lines are parallel and the cross section exhibits fully effective flow. For this example, cross section 5.44 was initially used as this section where the flow lines were parallel. After the pressure/weir flow analysis, the location of this cross section was evaluated using the procedures as outlined in the HEC study [HEC-1995]. This evaluation will be presented in the discussion near the end of this example.

**Manning's n Values.** The Manning's n values were obtained from the field data displayed on the USGS atlas. For some of the cross sections, the Manning's n values changed along the width of the overbank areas and the horizontal variation in n values option was selected, such as for cross section 5.99. This option was performed from the **Cross Section Data Editor** by selecting **Options** and **Horizontal Variation in n Values**. This caused a new column to appear under the Cross Section X-Y Coordinates heading (as shown in Figure 2.2). For cross section 5.99, the n values changed at the X-coordinates of 518 (in the left overbank), 866 (the main channel left bank station), and 948 (the main channel right bank station). This can be seen by scrolling down in the coordinates window of the cross section editor. The overbank areas have densely wooded areas, which created the necessity for the variation in n values. The final data are shown in the cross section plot in Figure 2.4.

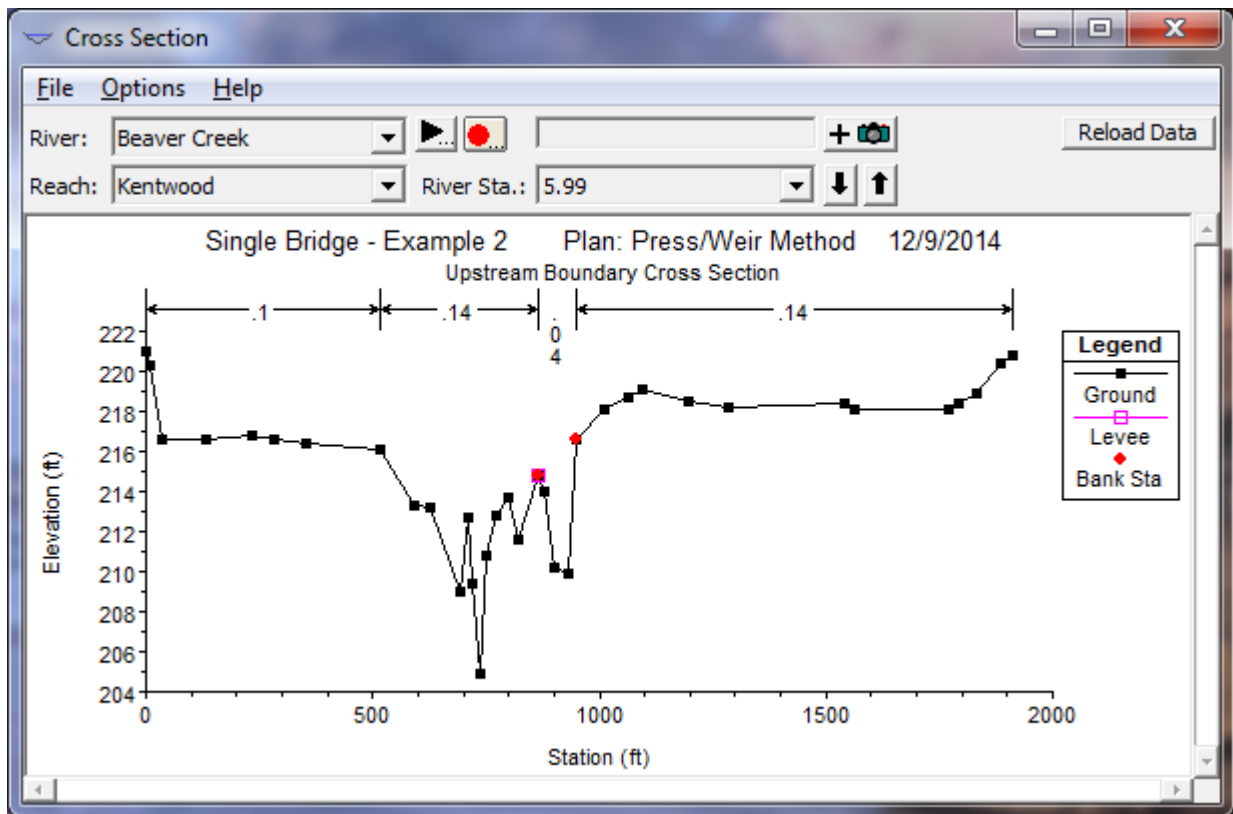
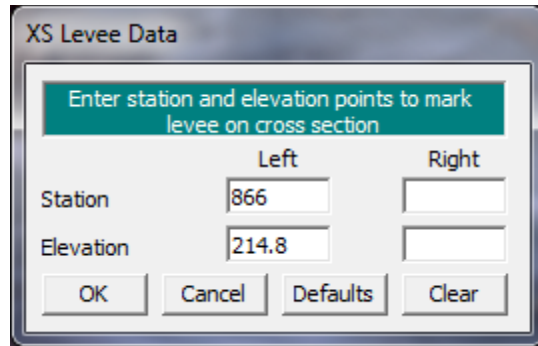

Figure 2-4: Cross Section 5.99: Horizontal  $n$  Variation and Levee Options

**Levees.** As can be seen in the plot of cross section 5.99 in Figure 2.4, there exists a large area to the left of the main channel that is lower in elevation than the invert of the main channel. During the analysis, the program will consider the water to be able to go anywhere in the cross section. The modeler must determine whether or not the lower area to the left of the main channel can initially convey flow. If the area cannot convey flow until the main channel fills up and then overtops, then the levee option should be used. For this example, a left levee was established at the left main channel bank station for river station 5.99. This prevents water from being placed to the left of the levee until the elevation of the levee is reached. The elevation selected for this levee was the elevation of the left side of the main channel.

To insert the levee, **Options** and then **Levees** were selected from the **Cross Section Data Editor**. This resulted in the display shown in Figure 2.5. The values for this example were station 866 and elevation 214.8 for a left levee. As can be seen in Figure 2.4, the levee is displayed as a small square located at the LOB station. Additionally, a note appears identifying the selection of a levee for the specific cross section at the bottom of the **Cross Section Data Editor**. This note can be seen in the box at the bottom of Figure 2.2. Levee options were selected for other cross sections in addition to cross section 5.99. In each case, the modeler needs to view each cross-section and determine whether the levee option needs to be utilized.



The image shows a software dialog box titled "XS Levee Data". At the top, a green banner contains the text "Enter station and elevation points to mark levee on cross section". Below this, the dialog is organized into two columns: "Left" and "Right". Under the "Left" column, there are two input fields: "Station" with the value "866" and "Elevation" with the value "214.8". The "Right" column has two empty input fields. At the bottom of the dialog, there are four buttons: "OK", "Cancel", "Defaults", and "Clear".

Figure 2-5: Levee Option for Cross Section 5.99

**Contraction/Expansion Coefficients.** The contraction and expansion coefficients are used by the program to determine the transition energy losses between two adjacent cross sections. From the data provided by the recent HEC study [HEC-1995], gradual transition contraction and expansion coefficients are 0.1 and 0.3, and typical bridge contraction and expansion coefficients are 0.3 and 0.5, respectively. For situations near bridges where abrupt changes are occurring, the coefficients may take larger values of 0.5 and 0.8 for contractions and expansions, respectively. A listing of the selected values for this river reach can be viewed by selecting **Tables** and then **Contraction/Expansion Coefficients (Steady Flow)** from the **Geometric Data Editor**. This table is shown in Figure 2.6 and displays the values selected for the river cross sections. Typical gradual transition values were selected for stations away from the bridge. However, near the bridge section, the coefficients were increased to 0.3 and 0.5 to represent greater energy losses. For additional discussion concerning contraction and expansion coefficients at bridges, refer to Chapter 5 of the **Hydraulic Reference Manual**.

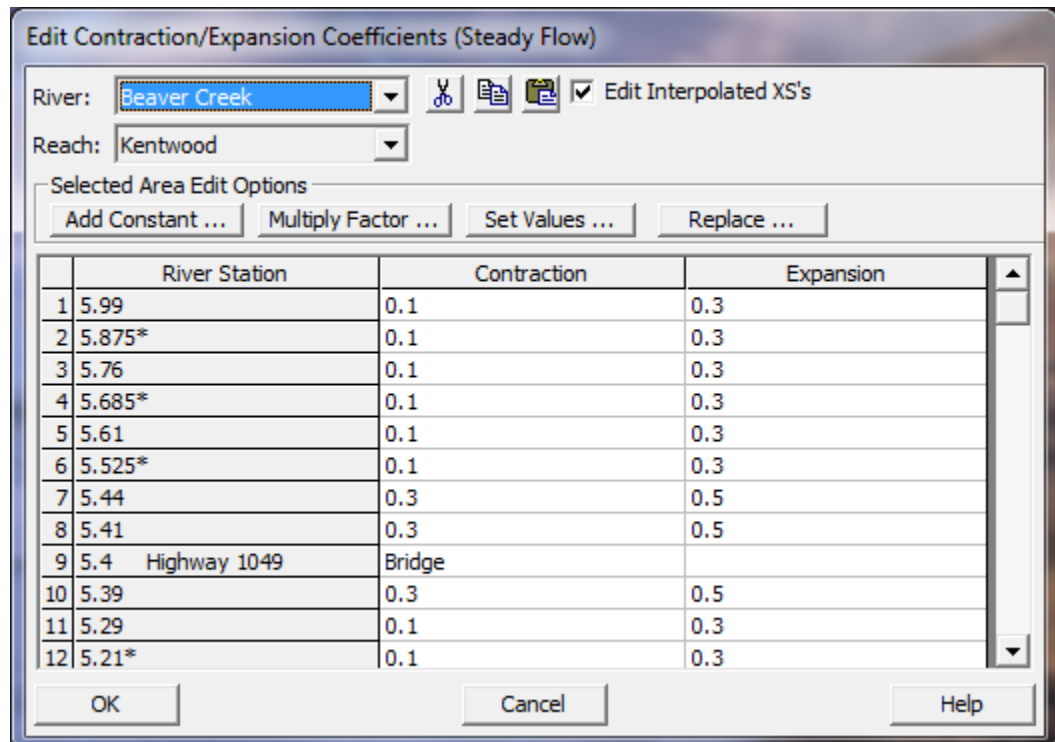

Figure 2-6: Coefficients For Beaver Creek

This completed the input for the cross section geometric data. Next, the bridge geometry data was entered as outlined in the proceeding section.

### Bridge Geometry Data

To enter the bridge geometry data, the **Bridge/Culvert** icon was selected from the **Geometric Data Editor**. This activated the **Bridge/Culvert Data Editor**. The river and reach were selected as "Beaver Creek" and "Kentwood" (the only reach for this example). Then, **Options**, and **Add a Bridge or Culvert** were selected and river station 5.4 was entered as the location for the bridge. **The Bridge/Culvert Data Editor** then displayed the upstream (river station 5.41) and downstream (river station 5.39) cross sections. A description was then entered as "Bridge #1." The following section provides a brief summary of the input for the bridge geometry including the bridge deck/roadway and then the bridge piers.

**Bridge Deck and Roadway Geometry.** From the **Bridge/Culvert Data Editor**, the **Deck/Roadway** icon was selected and this activated the **Deck/Roadway Data Editor**, as shown in Figure 2.7.

Distance			Width			Weir Coef		
30			40			2.61		

Upstream				Downstream			
	Station	high chord	low chord	Station	high chord	low chord	
1	0.	216.93	200.	0.	216.93	200.	
2	450.	216.93	200.	450.	216.93	200.	
3	450.	216.93	215.7	450.	216.93	215.7	
4	647.	216.93	215.7	647.	216.93	215.7	
5	647.	216.93	200.	647.	216.93	200.	
6	2000.	216.93	200.	2000.	216.93	200.	
7							
8							

Figure 2-7: Bridge/Deck and Roadway Data Editor

The first input at the top of the editor is the distance from the upstream side of the bridge deck to the cross section immediately upstream from the bridge (cross section 5.41). This distance was determined to be 30 feet from the USGS atlas. In the next field, the bridge deck width of 40 feet was entered. Finally, a weir flow coefficient of 2.6 was selected for the analysis. (Additional discussion of the weir flow coefficient will be presented in the calibration section.)

The central section of the **Deck/Roadway Editor** is comprised of columns for input of the station, high cord elevation, and low cord elevation for both the upstream and downstream sides of the bridge deck. The data are entered from left to right in cross section stationing and the area between the high and low cord is the bridge structure. The stationing of the upstream side of the deck was based on the stationing of the cross section located immediately upstream. Likewise, the stationing of the downstream side of the deck was based on the stationing of the cross section placed immediately downstream.

If both the upstream and downstream data are identical, the user needs only to input the upstream data and then select **Copy Up to Down** to enter the downstream data.

As a final note, the low cord elevations that are concurrent with the ground elevation were entered as a value lower than the ground elevation. The program will automatically clip off and remove the deck/roadway area below the ground. For example, at station 0, a low cord elevation of 200 feet was entered. However, the actual ground elevation at this point is approximately

216 feet. Therefore, the program will automatically remove the area of the roadway below the ground. Additionally, the last station was entered as a value of 2000 feet. This stationing ensured that the roadway and decking extended into the limits of the cross section geometry. As described previously, the program will clip off the area beyond the limits of the cross section geometry.

The **US** and **DS Embankment SS** (upstream and downstream embankment side slope) values were entered as 2 (horizontal to 1 vertical). These values are used for graphical representation on the profile plot and for the WSPRO low flow method. The user is referred to Example 13 - Bogue Chitto Single Bridge (WSPRO) for a discussion on the use of this parameter with the WSPRO method. The WSPRO method is not employed for this example.

At the bottom of the **Deck/Roadway Data Editor**, there are three additional fields for data entry. The first is the **Max Allowable Submergence**. This input is a ratio of downstream water depth to upstream energy, as measured above the minimum weir elevation. When the ratio is exceeded, the program will no longer consider the bridge deck to act as a weir and will switch the computation mode to the energy (standard step) method. For this example, the default value of 0.95 (95 %) was selected, however this value may be changed by the user.

The second field at the bottom of the editor is the **Min Weir Flow Elevation**. This is the elevation that determines when weir flow will start to occur over the bridge. If this field is left blank (as for this example), the program will default to use the lowest high cord value on the upstream side of the bridge. Finally, the last field at the bottom of the editor is the selection of the **Weir Crest Shape**. This selection will determine the reduction of the weir flow coefficient due to submergence. For this example, a broad crested weir shape was selected. Upon entering all of the above data, the **OK** button was selected to exit the **Deck/Roadway Data Editor**.

**Bridge Pier Geometry.** From the **Bridge/Culvert Data Editor**, select the **Pier** icon. This will result in the display shown in Figure 2.8. The modeler should not include the piers as part of the ground or bridge deck/roadway because pier-loss equations use the separate bridge pier data during the computations.



Pier Data Editor

Add Copy Delete Pier # 1

Del Row Centerline Station Upstream 470

Ins Row Centerline Station Downstream 470

Floating Pier Debris

All On ... All Off ...  Apply floating debris to this pier

Set Wd/Ht for all ... Debris Width: Debris Height:

	Upstream		Downstream	
	Pier Width	Elevation	Pier Width	Elevation
1	1.25	200.	1.25	200.
2	1.25	216.	1.25	216.
3				
4				
5				

OK Cancel Help Copy Up to Down

Select the Pier to Edit

Figure 2-8: Bridge Pier Data Editor

The program will establish the first pier as pier number 1. As shown in Figure 2.8, the upstream and downstream stations were entered for the centerline of the first pier. The upstream and downstream stations were based on the geometry of the cross sections located immediately upstream (cross section 5.41) and immediately downstream (cross section 5.39) of the bridge. The user needs to be cautious placing the pier centerline stations because the X-coordinates for the upstream and downstream cross section stationing may be different. This is to ensure that the piers "line up" to form the correct geometry. For this example, the pier centerline stations are 470, 490, 510, 530, 550, 570, 590, 610, and 630 for the nine piers. Each pier was set to start at an elevation of 200 feet (this elevation is below the ground level and the excess will be removed by the program) and end at an elevation of 216 feet (this elevation is inside the bridge decking and the excess was removed by the program). Additionally, each pier had a continuous width of 1.25 feet. After entering the data, the **OK** button was selected and the schematic of the bridge with the piers was displayed on the **Bridge/Culvert Data Editor** as shown on Figure 2.9. (Note: The figure in the text displays the ineffective flow areas that will be added in the next section.)

The cross sections shown in Figure 2.9 are developed by superimposing the bridge data on the cross sections immediately upstream (5.41) and immediately downstream (5.39) of the bridge. The top cross section in Figure 2.9 reflects the geometry immediately inside the bridge on the upstream side and the bottom cross section reflects the geometry immediately inside the bridge on the downstream side.

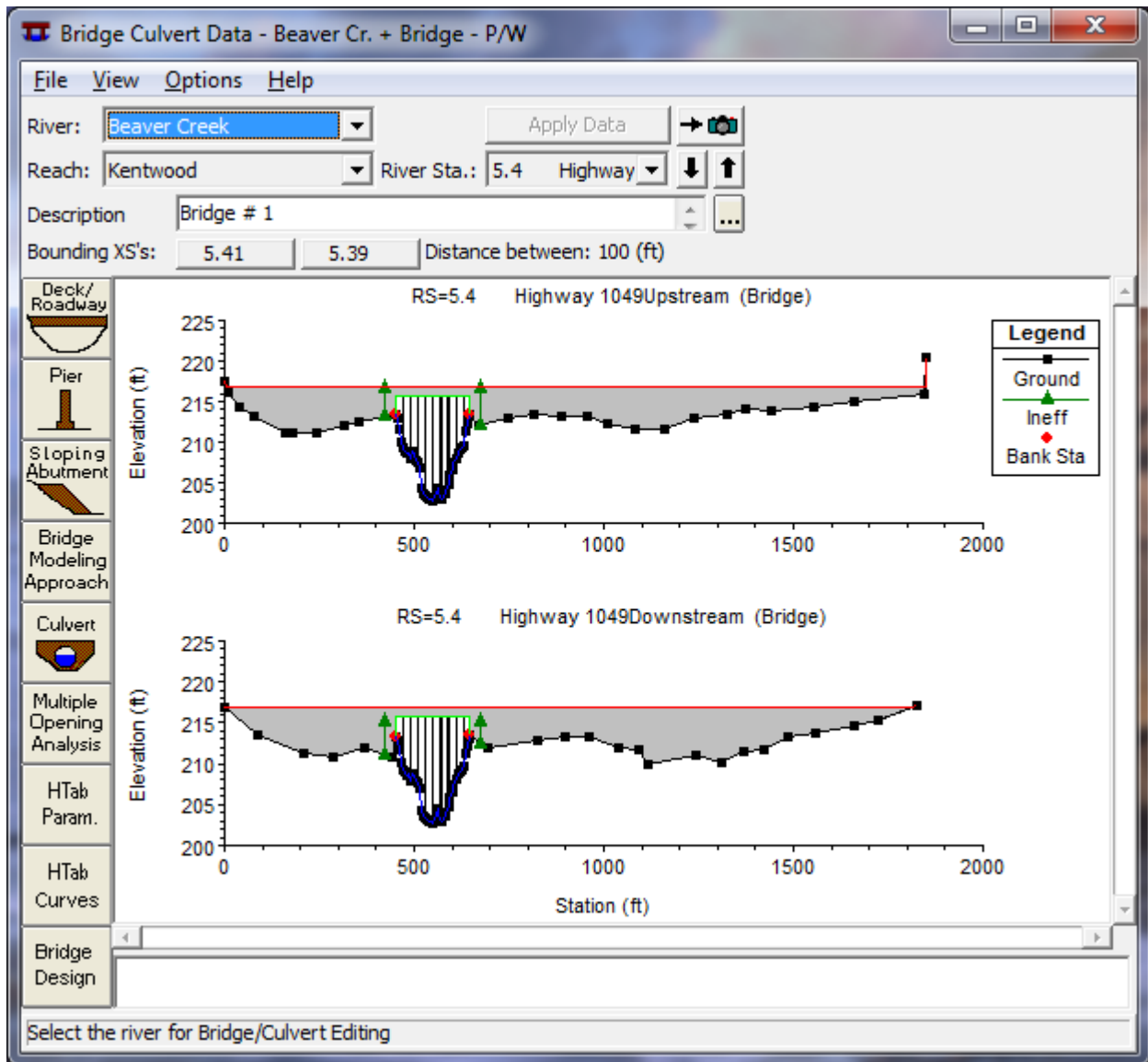

Figure 2-9: Bridge/Culvert Data Editor

While viewing the bridge, the modeler can select to view just the upstream, just the downstream, or both of the cross section views. This is performed by selecting **View** and then the required option. Additionally, from the **View** menu, the user should select **Highlight Weir**, **Opening Lid** and **Ground** as well as **Highlight Piers**. These options enable the modeler to view what the program will consider as the weir length, bridge opening, and pier locations. Any errors in the data may appear as inconsistent images with these options. Also, the zoom-in option will allow the user to examine data details.

As a final note for the bridge geometry, a bitmap image of the bridge was added to the geometry file (denoted by a red square on the river system schematic, Figure 2.1). The user can view this image by selecting the **View Picture** icon on the **Geometric Data Editor**.

## Ineffective Flow Areas

As a final step for the bridge geometry, any ineffective flow areas that existed due to the bridge (or any other obstruction) were entered. Ineffective flow is used to define an area of the cross section in which the water will accumulate but is not being actively conveyed. At a bridge, ineffective flow areas normally occur just upstream and downstream of the road embankment, away from the bridge opening.

For this example, ineffective flow areas were included on both the upstream cross section (5.41) and the downstream cross section (5.39). To determine an initial estimate for the stationing of the ineffective flow areas, a 1:1 ratio of the distance from the bridge to the cross section was used. For this example, section 5.41 is located 30 feet upstream of the bridge. Therefore, the left and right ineffective flow areas were set to start at 30 feet to the left and right of the bridge opening. Similarly, cross section 5.39 is located 30 feet downstream from the bridge and the ineffective flow areas at this cross section were set at 30 feet to the left and right of the bridge opening.

To determine the initial elevation of the ineffective flow areas for the upstream cross section, a value slightly lower than the lowest high cord elevation was used. This ineffective flow elevation was chosen so that when the water surface becomes greater than this ineffective elevation, the flow would most likely be weir flow and would be considered as effective flow. At the downstream cross section, the elevation of the ineffective flow area was set to be slightly lower than the low cord elevation. This elevation was chosen so that when weir flow occurs over the bridge, the water level downstream may be lower than the high cord, but yet it will contribute to the active flow area. (Additional discussion of the selection of these elevations is described in the calibration section of this example.)

To enter the ineffective flow areas, from the **Geometric Data Editor** select the **Cross Section** icon. Toggle to cross section 5.41 and select **Options** and then **Ineffective Flow Areas**. This will result in the display shown in Figure 2.10. The default option (normal) is to enter the areas as a left station and elevation and/or a right station and elevation. For this example, both the left and right ineffective flow areas were used.

Select Ineffective Mode	
<input checked="" type="radio"/> Normal	<input type="radio"/> Multiple Blocks
	Left                      Right
Station	420                      677
Elevation	216.7                      216.7
<input type="checkbox"/> Permanent	<input type="checkbox"/> Permanent
<input type="button" value="OK"/> <input type="button" value="Cancel"/> <input type="button" value="Defaults"/> <input type="button" value="Clear"/>	

Figure 2-10: Normal Ineffective Flow Areas For Cross Section 5.41

The left and right ineffective flow stations were entered as 420 and 677 feet, respectively. These values are 30 feet to the left and right of the bridge

opening, as discussed previously. The elevation was then entered as 216.7 feet, a value slightly lower than the high cord elevation. These entries imply that all the water to the left of the left station and to the right of the right station will be considered as ineffective flow until the water level exceeds the elevation of 216.7 feet.

Similarly, ineffective flow areas were set at river station 5.39 with a left station at 420 and a right station at 677, both at an elevation of 215.0 feet. The **OK** button was selected and the ineffective flow areas appeared as green triangles, as shown previously on Figure 2.9. Additionally, the ineffective flow areas will appear on the plots of the cross sections. Finally, a note will appear in the box at the bottom of the **Cross Section Data Editor** that states an ineffective flow exists for each cross section for which this option was selected.

### Bridge Modeling Approach

The bridge routines allow the modeler to analyze the bridge flows by using different methods with the same geometry. The different methods are: low flow, high flow, and combination flow. Low flow occurs when the water only flows through the bridge opening and is considered as open channel flow (i.e., the water surface does not exceed the highest point of the low cord on the upstream side of the bridge). High flow occurs when the water surface encounters the highest point of the low cord on the upstream side of the bridge. Finally, combination flow occurs when both low flow or pressure flow occur simultaneously with flow over the bridge. The modeler needs to select appropriate methods for both the low flow and for the high flow methods. For the combination flow, the program will use the methods selected for both of the flows.

From the **Geometric Data Editor**, select the **Bridge/Culvert** icon and then the **Bridge Modeling Approach** button. This will activate the **Bridge Modeling Approach Editor** as shown in Figure 2.11. For this example, there is only 1 bridge opening located at this river station and therefore the bridge number was 1. The following sections describe the additional parameters of the bridge modeling editor. The modeler is referred to Chapter 6 of the **User's Manual** and Chapter 5 of the **Hydraulic Reference Manual** for additional discussion on the bridge modeling approach editor.

**Low Flow Methods.** Low flow exists when the flow through the bridge is open channel flow. As can be seen in Figure 2.11, the program has the capability of analyzing low flow with four methods:

- Energy Equation (Standard Step)
- Momentum Balance
- Yarnell Equation (Class A only)
- WSPRO Method (Class A only)

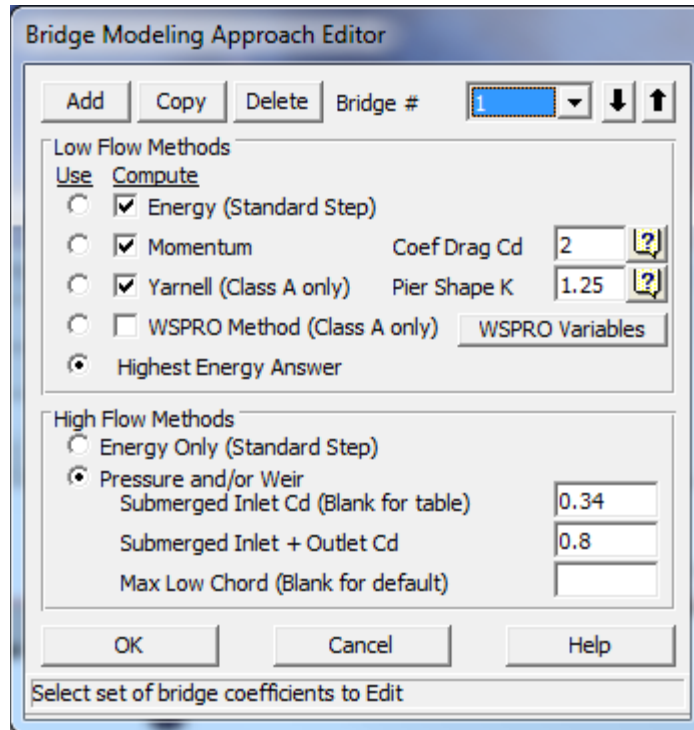

Figure 2-11: Bridge Modeling Approach Editor

The *Energy Equation (Standard Step)* method considers the bridge as just being part of the natural channel and requires Manning's  $n$  values for the friction losses through the bridge and coefficients of contraction and expansion. The *Momentum Balance* method performs a momentum balance through the bridge area and requires the selection of a drag coefficient,  $C_d$ . This coefficient is used to estimate the force due to the water moving around the piers, the separation of flow, and the resulting downstream wake. The *Yarnell Equation* is an empirical equation based on lab experiments. Finally, the *WSPRO* method is an energy based method developed by the USGS for the Federal Highway Administration.

At this time, the modeler needs to select which methods the program should compute and which method the program should use. The modeler can select to have the program compute particular methods or all of the methods. Then, the modeler needs to select which method the program will use as a final solution. Alternatively, the modeler can select the computation of several or all of the methods, and then have the program use the method with the greatest energy loss for the final solution. This will allow the modeler to view the results of all the methods and compare the results of the different techniques.

For this example, the Energy, Momentum, and Yarnell methods were selected to be computed. For the momentum method, a drag coefficient  $C_d = 2.00$  was entered for the square nose piers and for the Yarnell method, a value of  $K = 1.25$  was entered. Finally, the method that resulted in the greatest energy loss was selected to be used for the solution. (The user is referred to Example 13 for an application of the WSPRO method.)

**High Flow Methods.** High flows occur when the water surface elevation upstream of the bridge is greater than the highest point on the low cord of the upstream side of the bridge. Referring to Figure 2.11, the two

alternatives for the program to compute the water surface elevations during the high flows are: *Energy Only (Standard Step)* or *Pressure and/or Weir Flow*. The *Energy Only (Standard Step)* method regards the flow as open channel flow and considers the bridge as an obstruction to the flow. Typically, most bridges during high flows may act primarily as just an obstruction to the flow and the energy method may be most applicable.

As a second method for the analysis of high flows, the program can consider the flow to be causing *Pressure Flow and/or Weir Flow*. For pressure flow, there are two possible scenarios. The first is when only the upstream side of the bridge deck is in contact with the water. For this scenario, the submerged inlet coefficient,  $C_d$ , was set to be 0.34. (This value was arrived at during the calibration, which is described later in this example.) The second scenario for pressure flow is when the bridge constriction is flowing completely full. For this situation, the submerged inlet and outlet coefficient was set to 0.80.

The program will begin to calculate either type of pressure flow when the computed low flow energy grade line is greater than the highest point of the upstream low cord. Alternatively, the user can set the elevation at which pressure flow will begin to be checked, instead of the highest low cord value. This value can be entered as the last input to the **Bridge Modeling Approach Editor** (Figure 2.11). For this example, this field was left blank which implies that the program used the highest value of the low cord (the default). As an additional option, the user can select to have the program begin to calculate the pressure flow by using the value of the water surface instead of the value of the energy grade line. This is accomplished from within the **Bridge/Culvert Data Editor** by selecting **Options** and then **Pressure flow criteria**. This will result in the display shown in Figure 2.12. For this example, the option to use the upstream energy grade line was chosen.

Finally, for the high flow analysis, *Weir Flow* occurs when the upstream energy grade line elevation (as a default setting) exceeds the lowest point of the upstream high cord. The weir flow data was entered previously in the **Deck/Roadway Data Editor**. At this point, all of the bridge data have been entered. The user should exit the geometry data editors and save the geometry data. For this example, the geometry data was saved as the file "Beaver Cr. + Bridge - P/W."

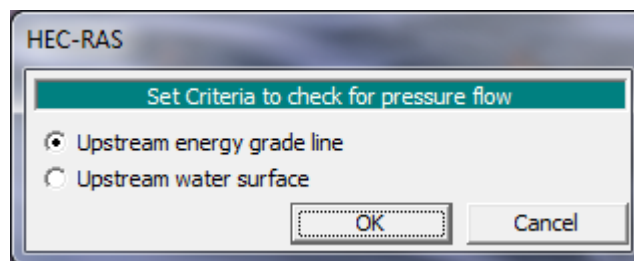

Figure 2-12: Pressure Flow Check Criteria

## Steady Flow Data

To enter the steady flow data, from the main program window **Edit** and then **Steady Flow Data** were selected. This activated the **Steady Flow Data Editor** as shown in Figure 2.13. For this analysis on the reach of Kentwood, three profiles were selected to be computed. The flow data were entered for

river station 5.99 (the upstream station) and the flow values were 5000, 10000, and 14000 cfs. These flows will be considered continuous throughout the reach so no flow change locations were used. Additionally, the three profile names were changed from the default values of "PF#1," etc., to "25 yr," "100 yr," and May '74 flood," respectively. These names will be used to represent the flow profiles when viewing the output.

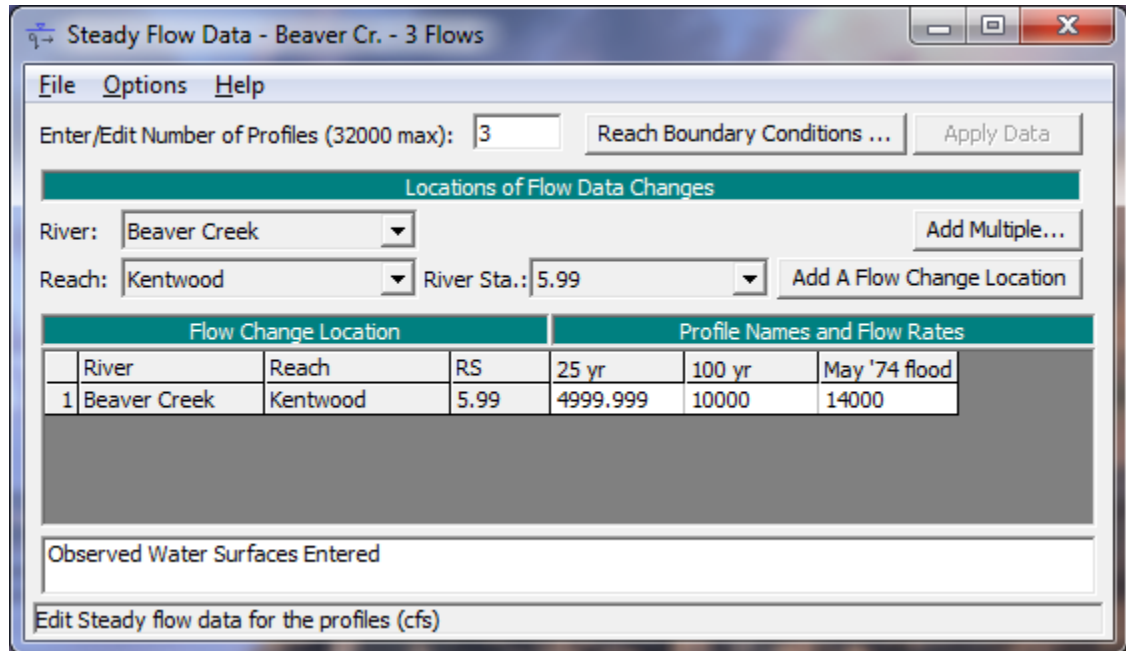

Figure 2-13: Steady Flow Data Editor

To enter the boundary conditions, the **Reach Boundary Conditions** button was selected and this resulted in the display shown in Figure 2.14. For this example, a subcritical analysis was performed. Therefore, a downstream boundary condition was required for each flow value. The mouse arrow was placed over the downstream field and then the box was selected (highlighted). Then, 1 of the 4 boundary conditions was selected and this caused the type of boundary condition that was chosen to appear in the downstream end of the reach.

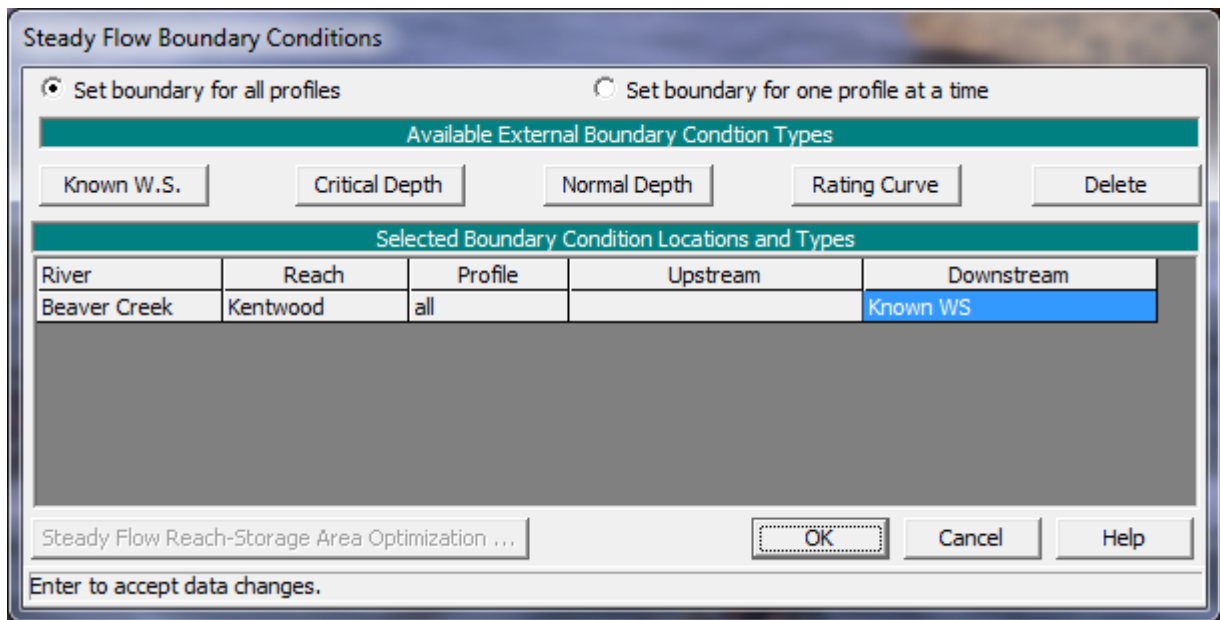

Figure 2-14: Steady Flow Boundary Conditions

For this example, **Known W. S.** was selected. This caused the input editor as shown in Figure 2.15 to appear. For each of the flows, the known downstream water surface elevations of 209.5, 210.5, and 211.8 feet were entered for the flows 1, 2, and 3, respectively. These values were obtained from observed data on the USGS Atlas.

For the purposes of the analysis, if the downstream boundary conditions are not known, then the modeler should use an estimated boundary condition. However, this may introduce errors in the region of this estimated value. Therefore, the modeler needs to have an adequate number of cross sections downstream from the main area of interest so that the boundary conditions do not effect the area of interest. Multiple runs should be performed to observe the effect of changing the boundary conditions on the output of the main area of interest. For a detailed explanation of the types of boundary conditions, refer to Chapter 7 of the **User's Manual** and Chapter 3 of the **Hydraulic Reference Manual**. After entering the boundary condition data, the **OK** button was selected to exit the editor. This completed the necessary input for the flow data and the steady flow data was then saved as "Beaver Cr. - 3 Flows."

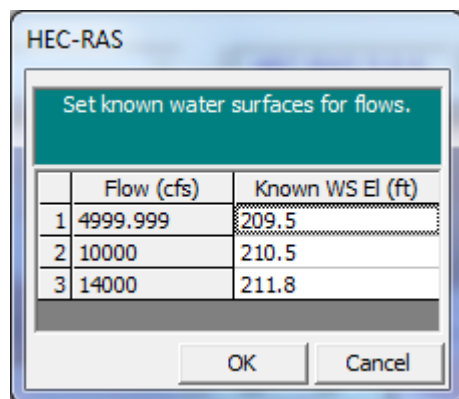



Figure 2-15: Known Water Surface Boundary Conditions

## Pressure/Weir Flow Simulation

To perform the steady flow analysis, from the main program window **Run** and then **Steady Flow Analysis** were selected. This activated the **Steady Flow Analysis Window** as shown in Figure 2.16. First, it was ensured that the geometry file and steady flow file that were previously developed appeared in the selection boxes on the right side of the window. Then, for this simulation, a subcritical flow analysis was selected. Additionally, from the **Steady Flow Analysis** window, **Options** and then **Critical Depth Output Option** were selected. An "x" was placed beside the option for **Critical Always Calculated**. This may require additional computation time during program execution, but then the user can view the critical depth elevation at all river stations during the review of the output.

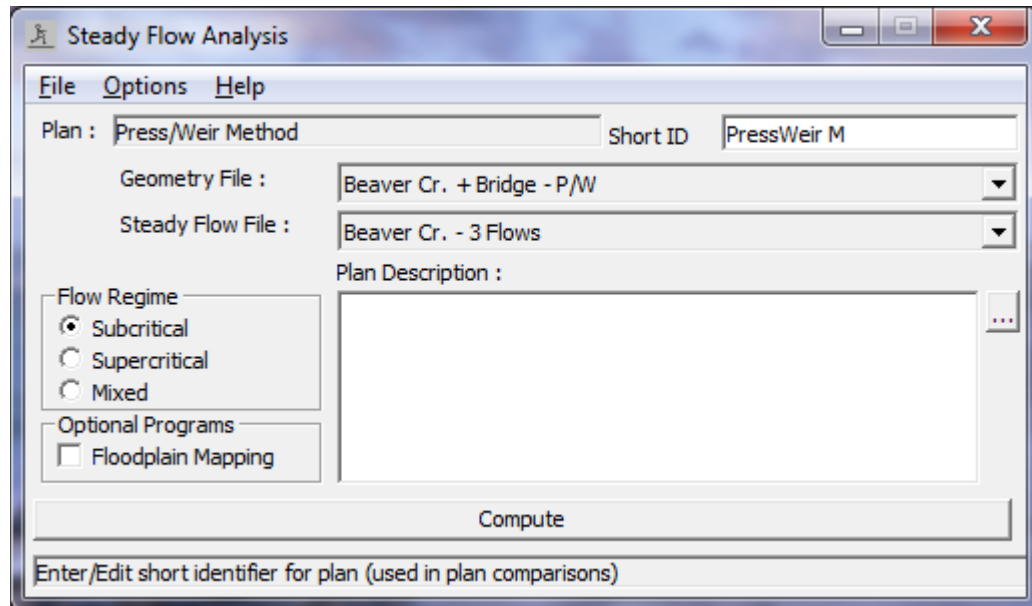

Figure 2-16: Steady Flow Analysis

Select **Options** and then ensure that there is a check mark " in front of **Check data before execution**. This will cause the program to check all of the input data to ensure that all pertinent information was entered. Next, the options were saved as a plan entitled "Press/Weir Method," with a Short ID entered as "Press/Weir." Finally, **COMPUTE** was selected at the bottom of the window.

## Review of Pressure/Weir Flow Output

After the program has completed the analysis, the last line should read "PROGRAM TERMINATED NORMALLY." This window is closed by double clicking the bar in the upper left corner of the display. From the main program window, **View** and then **Water Surface Profiles** were selected. This displayed the profile plot as shown in Figure 2.17, showing the water surface elevations and critical depth lines for all three profiles. (Note: the

variables that are displayed can be changed by selecting **Options** and then **Variables**.)

From Figure 2.17, it can be seen that all three of the flow profiles are occurring in the subcritical flow regime. This ensures that for the low flow analysis, Class A low flow (subcritical flow) was occurring through the bridge. Low flow occurred for the first (5000 cfs) and for the second (10000 cfs) flow profiles. For the high flow, the method of analysis was chosen to be pressure/weir flow. Pressure and weir flow occurred during the third flow profile (14000 cfs). One way to determine the type of flow that occurred is by viewing the bridge only output table. This table is presented in Figure 2.18 and was activated from the main program window by selecting **View**, **Profile Table**, **Std. Tables**, and then **Bridge Only**.

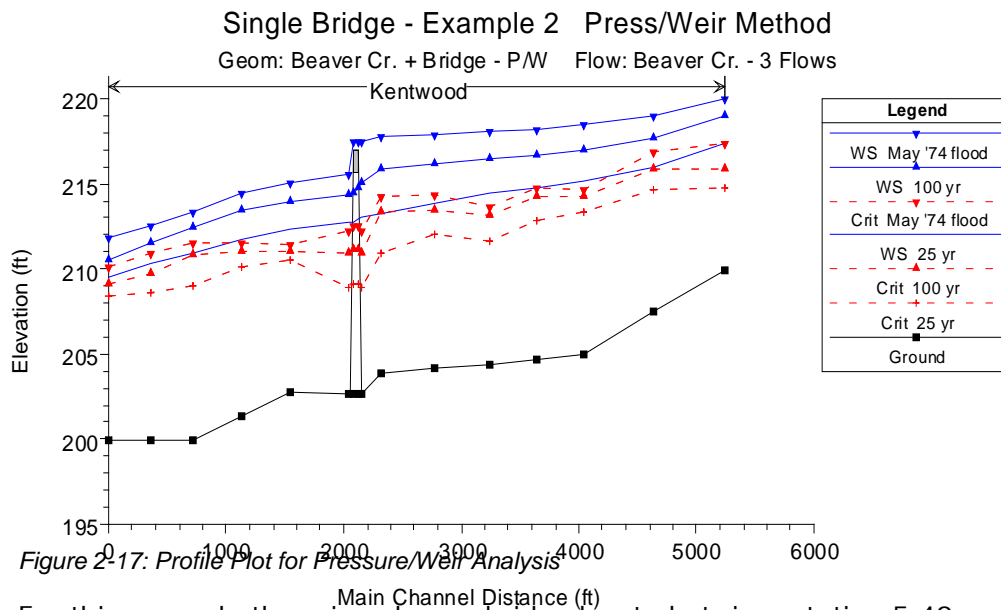

Figure 2-17: Profile Plot for Pressure/Weir Analysis

For this example there is only one bridge located at river station 5.40, as listed in the table. Pressure flow calculations were set to begin when the energy grade line elevation of the upstream section (5.41) was greater than the highest elevation of the upstream low cord (215.7 ft). The first column in Figure 2.18 shows the energy grade line elevation of the upstream section (EG US) and the second column shows the elevation when pressure flow was set to begin. A comparison of these two columns shows that pressure flow occurred for the third profile. Additionally, it can be seen that weir flow occurred for the third profile, since there is a weir flow value for the third profile. The following sections detail the output for the first two profiles and then for the third flow profile.

Profile Output Table - Bridge Only											
HEC-RAS Plan: Press/Weir M River: Beaver Creek Reach: Kentwood											
Reach	River Sta	Profile	E.G. US. (ft)	Min El Prs (ft)	BR Open Area (sq ft)	Prs O WS (ft)	Q Total (cfs)	Min El Weir Flow (ft)	Q Weir (cfs)	Delta EG (ft)	
Kentwood	5.4	Highway 1049	25 yr	213.31	215.70	1600.36	5000.00	216.94		0.26	
Kentwood	5.4	Highway 1049	100 yr	215.66	215.70	1600.36	10000.00	216.94		0.54	
Kentwood	5.4	Highway 1049	May '74 flood	217.67	215.70	1600.36	221.60	14000.00	216.94	3069.23	1.66

Upstream energy grade elevation at bridge or culvert (specific to that opening, not necessarily the weighted average).

Figure 2-18: Bridge Only Summary Table for Pressure/Weir Flow

**First and Second Flow Profiles.** The first (5000 cfs) and second (10000 cfs) flow profiles were both computed using the low flow methods of: Energy, Momentum, and Yarnell. From the main program window, select View, **Profile Table, Standard Tables**, and then **Bridge Comparison**. This will provide a comparison table for the different energy loss methods and is shown in Figure 2.19.

In Figure 2.19, the three rows display the results for each of the three flow profiles, in ascending order. The river station is set at 5.4 (the only bridge location for this reach). The fourth column shows the water surface elevation immediately upstream of the bridge. The sixth, seventh and eighth columns show the results of the low flow methods that were chosen to be computed: Energy, Momentum, and Yarnell Methods, respectively. The program compared the results and used the value with the greatest energy loss. For the first and second profiles, the energy method calculated the greatest energy losses and the program used the results of 213.31 and 215.66 feet, respectively.

HEC-RAS Plan: Press/Weir M River: Beaver Creek Reach: Kentwood											
Reach	River Sta	Profile	E.G. US. (ft)	W.S. US. (ft)	Br Sel Method	Energy EG (ft)	Momen. EG (ft)	Yarnell EG (ft)	WSPRO EG (ft)	Prs O EG (ft)	Prs/Wr EG (ft)
Kentwood	5.4	Highway 1049	25 yr	213.31	213.03	Energy only	213.31	213.30	213.10		
Kentwood	5.4	Highway 1049	100 yr	215.66	215.05	Energy only	215.66	215.60	215.27		
Kentwood	5.4	Highway 1049	May '74 flood	217.67	217.43	Press/Weir	217.37			221.66	217.67

Upstream energy grade elevation at bridge or culvert (specific to that opening, not necessarily the weighted average).

Figure 2-19: Bridge Comparison Table for Pressure/Weir Flow Analysis

**Third Flow Profile.** The third flow profile was computed for a flow of 14000 cfs. As can be seen in Figure 2.18, approximately 3050 cfs of the total flow was weir flow. The remaining flow, approximately 10950 cfs, was pressure flow through the bridge opening. As can be seen in Figure 2.19, the energy grade line necessary for pressure-only flow was 221.66 feet. Since this value

is greater than the upstream high cord, weir flow also developed. Therefore, the program used the pressure/weir energy value as the solution to the high flow method, namely 217.67 feet.

## Energy Method Analysis

As a second approach to analyze the three flows, the energy method will be used instead of the pressure/weir flow method for the high flows. From the **Steady Flow Analysis Window**, select **File, Open Plan**, and then select "Energy Method." This will activate the plan that employed the energy method for the analysis. The following discussion outlines the procedure used to develop this plan.

### Energy Method Data and Simulation

To enter the data for the energy method, from the main program window **Edit, Geometric Data**, the **Bridge/Culvert** icon, and then the **Bridge Modeling Approach** icon were selected. This activated the **Bridge Modeling Approach Editor** as was shown in Figure 2.11. The **Energy Only (Standard Step)** option was then selected as the high flow method (instead of the Pressure/Weir method). Then, the editor was closed and the geometry was saved as "Beaver Cr. + Bridge - Energy." Next, **Run** and then **Steady Flow Analysis** were selected from the main program window. This activated the **Steady Flow Analysis Window**. The geometry file was selected as "Beaver Cr. + Bridge - Energy" and the steady flow file was "Beaver Cr. - 3 Flows" (the same steady flow file as used previously). Then, a Short ID was entered as "Energy" and the options were saved as the plan "Energy Method." Finally, **COMPUTE** was selected to perform the steady flow analysis.

### Review of Energy Method Output

From the main program window, select **View, Profile Table, Standard Tables**, and then **Bridge Comparison**. This bridge comparison table is shown in Figure 2.20. For the first and second profiles, the table shows the same results as for the pressure flow analysis. This is as would be expected since the first and second profiles were calculated using the same low flow procedures. For the third profile, the energy method was used to calculate the energy losses through the bridge for this high flow and resulted in an energy gradeline elevation of 217.37 feet.

Reach	River Sta	Profile	E.G. US. (ft)	W.S. US. (ft)	Br Sel Method	Energy EG (ft)	Momen. EG (ft)	Yarnell EG (ft)	WSPRO EG (ft)	Prs O EG (ft)	Prs/Wr EG (ft)	Energy/Wr EG (ft)
Kentwood	5.4	25 yr	213.31	213.03	Energy only	213.31	213.30	213.10				
Kentwood	5.4	100 yr	215.66	215.05	Energy only	215.66	215.60	215.27				
Kentwood	5.4	May '74 flood	217.37	217.09	Energy only	217.37						

Upstream energy grade elevation at bridge or culvert (specific to that opening, not necessarily the weighted average).

Figure 2-20: Bridge Comparison Table for Energy Method Analysis

## Evaluation of Cross Section Locations

As stated previously, the locations of the cross sections and the values selected for the expansion and contraction coefficients in the vicinity of the bridge are crucial for accurate prediction of the energy losses through the bridge structure. For this example, the locations of the cross sections and the energy loss coefficients were evaluated for the high flow event. The following analysis is based on data that were developed for low flow events occurring through bridges and the modeler should use caution when applying the procedure for other than low flow situations. Each of the reach length and coefficient evaluation procedures are discussed in the following sections.

### Expansion Reach Length

The expansion reach length,  $L_e$ , is defined as the distance from the cross section placed immediately downstream of the bridge to the cross section where the flow is assumed to have fully expanded. For this example, this distance is from cross section 5.39 to cross-section 5.29. Initially, the expansion reach length is estimated according to observed field data or other appropriate method. For this example, observed data were available so the initial estimate of the expansion reach length was obtained from the field observations. After the analysis, the modeler can evaluate the initial estimate of the expansion reach length. For the analysis, it is recommended to use the regression results from the US Army Corps of Engineers (USACE) study [HEC-1995]. The results of the study suggest the use of Equation 2-1 to evaluate the expansion reach length. This equation is valid when the modeling situation is similar to the data used in the regression analysis. (In the document, alternative expressions are presented for other situations.) The equation is:

$$L_e = ER \left( \frac{\bar{L}_{obs}}{L_e} \right) = 298 + 257 \left( \frac{F_{5.39}}{F_{5.29}} \right) + 0.918 \left( \frac{\bar{L}_{obs} F_{5.39}}{F_{5.29}} \right) + 0.00479 Q \quad (2-1)$$

where:  $L_e$  = expansion reach length, ft

$ER$  = expansion ratio

$F_{5.39}$  = main channel Froude number at the cross section immediately downstream of the bridge (cross section 5.39 for this example)

$F_{5.29}$  = main channel Froude number at the cross section of fully expanded flow (initially cross section 5.29 for this example)

$\bar{L}_{obs}$  = average length of obstruction caused by the two bridge approaches, ft

$Q$  = total discharge, ft<sup>3</sup>/s

(Note: The subscripts used in Equation 2-1 and all subsequent equations reflect the river station numbering for this example.)

From the field data, the average length of the obstruction is approximately 740 feet and the total discharge,  $Q$ , is 14000 cfs for the high flow event. From the initial analysis, the values of the Froude number at cross-section 5.39 was 0.37 and at cross section 5.29 was 0.30. (Both of these values were the same for pressure/weir and energy methods and are displayed on **Standard Table 1**.) Substituting the values into Equation 2-1 yielded that the expansion reach length,  $L_e$ , was approximately 778 feet. This equation has a standard error of 96 feet, which yields an expansion reach length range from 682 to 874 feet to define the 68% confidence band. The distance used for the expansion reach length (the distance from cross section 5.39 to cross-section 5.29) was set to be 500 feet in the main channel, which is less than the recommended range from the equation. The modeler now has the option to adjust this length so that it is within the calculated range. Then, after a new analysis, the new Froude numbers should be used to calculate a new expansion reach length. If the geometry is not changing rapidly in this region, then only 1 or 2 iterations should be necessary to obtain a constant expansion reach length value.

For this example, the location of the fully expanded cross section was changed to reflect the new expansion reach length (778 feet) by interpolating a new cross section to be located 778 feet downstream from cross section 5.39. To accomplish this, the following steps were taken. First, the pressure/weir flow plan ("Pressure/Weir Method") was activated. Then, in the **Geometric Data Editor**, a cross section was interpolated between cross sections 5.29 and 5.21\*. This interpolated cross section (5.24\*) was set to be at a distance of 278 feet downstream from cross section 5.29. Since cross section 5.29 was already located 500 feet downstream from cross section 5.39, the location of cross section 5.24\* was then  $500 + 278 = 778$  feet downstream from cross section 5.39. The cross sections 5.29, 5.27\*, and 5.21\* were then deleted.

Finally, this new geometric data was saved as a file called "Bvr.Cr.+Bridge - P/W: New  $L_e$ ,  $L_c$ ." On the **Steady Flow Analysis Window**, a *Short ID* was entered as "P/w+NewLeLc" and then the new geometry file and the original steady flow data file were saved as a plan entitled "Press/Weir Method: New  $L_e$ ,  $L_c$ ." The **Geometric Data Editor** was then reactivated and the **Bridge Modeling Approach Data Editor** was selected. The high flow method was chosen to be the energy method and then the geometry data was saved as "Bvr.Cr.+Bridge - Energy: New  $L_e$ ,  $L_c$ ." The **Steady Flow Analysis Window** was activated, a *Short ID* was entered as "En.+New LeLc," and the new energy geometry file and the steady flow data file were then saved as a new plan entitled "Energy Method : New  $L_e$ ,  $L_c$ ." This procedure created two new plans, with each plan containing the necessary interpolated geometry and appropriate high flow calculation methods.

Each of the two new plans were then executed and the resulting flow parameter values were reentered into Equation 2-1. (Note: The Froude number for river station 5.29 was replaced by the Froude number at river station 5.24\* in Equation 2-1.) The final mean value of the expansion reach length was then determined to be 750 feet, with a range of  $\pm 96$  feet to define the 68% confidence band. The adjusted reach length value of 778 feet is within the confidence band and no additional iterations were computed. Finally, the expansion ratio (ER) as described in Equation 2-1 should not

exceed 4:1 and should not be less than 0.5:1. For this example, the final expansion ratio was  $ER = (778) / (740) = 1.05$ , which is within the acceptable range. In the above procedure, the modeler is directed to Chapter 4 of the **Hydraulic Reference Manual** for additional information on cross section interpolation and to Chapter 5 of the **User's Manual** for further discussion on working with projects.

Upon reviewing the above procedures, the modeler can open either of these new plans and the corresponding geometry and flow data files will be activated. For this example, the results of the water surface profiles for the new plans are approximately equal to the results obtained from the original geometry for both of the pressure/weir flow and energy methods, respectively. However, the modeler should apply the above procedures to evaluate the location of the expansion reach length for each specific application.

Finally, during the procedures as outlined above, if the location of the expansion reach length produces a distance sufficiently far downstream from the bridge, then the modeler may be required to include additional cross sections within this reach length to accurately predict the energy losses. This may be accomplished by inserting cross sections and providing the appropriate ineffective flow areas at each cross section according to their location with respect to the bridge opening.

### Contraction Reach Length

The contraction reach length,  $L_c$ , is defined as the distance from the cross section located immediately upstream of the bridge (5.41) to the cross section that is located where the flow lines are parallel and the cross section exhibits fully effective flow (5.44). To evaluate this reach length, the regression results (shown as Equation 2-2 below) from the US Army Corps of Engineers (USACE) study [HEC-1995] was used. The equation is:

$$L_c = CR(\bar{L}_{obs}) = 263 + 38.8 \left( \frac{F_{5.39}}{F_{5.29}} \right) + 257 \left( \frac{Q_{ob}}{Q} \right)^2 - 58.7 \left( \frac{n_{ob}}{n_c} \right)^{0.5} + 0.161 \bar{L}_{obs} \quad (2-2)$$

where:  $L_c$  = contraction reach length, ft

$CR$  = contraction ratio

$F_{5.39}$  = main channel Froude number at the cross section immediately downstream of the bridge (cross section 5.39 for this example)

$F_{5.29}$  = main channel Froude number at the cross section of fully expanded flow (initially cross section 5.29 for this example)

$Q_{ob}$  = discharge conveyed in the two overbanks at cross section 5.44, cfs

*Example 2 Beaver Creek – Single Bridge*

---

$Q$  = total discharge, ft<sup>3</sup>/s

$n_{ob}$  = Manning n value for the overbanks at section 5.44

$n_c$  = Manning n value for the main channel at section 5.44

From the field data and the results of the initial analysis, the Froude numbers at sections 5.39 and 5.29 were 0.37 and 0.30, respectively, the total over bank flow at cross section 5.44 was approximately 9780 cfs (an average of 9880 for the pressure/weir flow and 9685 for the energy method), the total flow was 14000 cfs, the weighted n value for both of the overbanks was 0.069, the n value for the main channel was 0.04, and the average length of the obstruction was 740 feet. Substitution of these values into Equation 2-2 yielded the contracted reach length of 478 feet. This equation has a standard error of 31 feet which results in a contraction reach length range from 447 to 509 feet to define the 68% confidence band. For this example, the distance from cross section 5.44 to cross section 5.41 was set at 170 feet along the main channel. Since this value was outside of the confidence range, the reach length was adjusted to reflect the new contraction reach length.

The adjustment of the geometry for the new contraction reach length was performed similarly to the adjustment procedure for the expansion reach length. A cross section (5.49\*) was interpolated between river stations 5.525\* and 5.44 that was set to be 308 feet upstream of river station 5.44. Then, the reach length from river station 5.49\* to river station 5.41 was 308 + 170 = 478 feet, the required contraction reach length. This new river station can be viewed by opening the plan "Press/Weir Method: New Le, Lc" for the pressure/weir method or the plan "Energy Method: New Le, Lc" for the energy method analysis.

Finally, after the subsequent analysis with the new contraction reach length, the new flow parameters were entered into Equation 2-2 and yielded a contraction reach length of 499 feet, with a range from 468 to 530 feet to define the 68% confidence band. The adjusted contraction reach length of 478 feet is within this range and no additional iterations were necessary. (Note: The Froude number for river station 5.29 was replaced by the Froude number at river station 5.24\* in equation 2-2.)

As a final criteria, the contraction ratio (CR) should not exceed 2.5:1 nor should it be less than 0.3:1. For this example, the final contraction ratio was  $CR = (499) / (740) = 0.67$ , which is within the acceptable range. Table 2-1 shows a relationship of the values computed for the expansion reach lengths and the contraction reach lengths during the iterations as described above. Additionally, the table shows the values as determined by the USGS and the traditional USACE methods.

*Table 2-1: Expansion and Contraction Reach Length Determinations*

<b>Expansion or Contraction Reach Length Determination Method</b>					
	USGS	Traditional USACE	Initial Placement from field data	HEC-1995 1st iteration	HEC-1995 2nd iteration
Le	200	2964	500	770	747
Lc	200	740	170	478	499



As can be seen from the data in Table 2.1, the USGS method will typically provide a minimum criteria and the traditional USACE method will provide a maximum length. The recent study [HEC-1995] was performed to provide better guidance for the evaluation of the reach lengths and these values fall within the range as determined by the previous two methods.

### Expansion Coefficient

The expansion coefficient is used to determine the amount of energy loss due to the flow expanding between two particular cross sections. The research document [HEC-1995] suggests the following relationship for the value of the expansion coefficient:

$$C_e = -0.09 + 0.570 \left( \frac{D_{ob}}{D_c} \right) + 0.075 \left( \frac{F_{5.39}}{F_{5.29}} \right) \quad (2-3)$$

where:  $C_e$  = expansion coefficient

$D_{ob}$  = hydraulic depth (flow area / top width) for the overbank at cross section 5.29

$D_c$  = hydraulic depth in the main channel at cross section 5.29

From the data for the analysis, the hydraulic depth for the overbank at cross section 5.29 was 4.26 feet (an average of 5.31 and 3.20 feet for the LOB and ROB, respectively, with the values being consistent for both the pressure/weir flow and energy method) and the hydraulic depth of the main channel was 7.20 feet. Substitution of the values for the variables yielded an expansion coefficient of 0.34. This is the median value and the range of  $\pm 0.2$  defines the 95% confidence band for Equation 2-3. Therefore, the modeler should use the value of 0.34 as an initial value and vary the coefficient by  $\pm 0.2$ . For this example, a value of 0.5 was initially used for the expansion coefficient in the vicinity of the bridge. During the iterations for the contraction and expansion reach lengths, this coefficient was reevaluated for each iteration. For the final value, the hydraulic depth in the overbank at cross section 5.24\* was 4.11 feet (an average of 5.06 and 3.16 feet for the LOB and ROB, respectively, with the values being consistent for both the pressure/weir flow and energy method) and the hydraulic depth of the main channel was 8.40 feet. This yielded an expansion coefficient of 0.27,  $\pm 0.2$ . For the example, a final value of 0.5 was calibrated in order to match the observed data.

### Contraction Coefficient

The contraction coefficient is used to determine the amount of energy loss due to the flow contracting between two particular cross sections. The data of the study [HEC-1995] did not lend itself to regression of the contraction coefficient values and an approximate range is recommended by the research. For this example, a range of 0.3 to 0.5 is recommended by the

research. A value of 0.3 was used for the contraction coefficient in the vicinity of the bridge.

In summary, the above recommendations for the expansion reach length, the contraction reach length, and the expansion and contraction coefficients represent an improvement in the general methodology behind the prediction of these values. The modeler is recommended to apply these new criteria as a more substantial method for estimating the transition reach lengths. As a final note, after the initial analysis, the expansion and the contraction reach lengths as well as the expansion and contraction coefficients should be evaluated simultaneously. Then, adjustments should be made to the reach length and coefficient values before a subsequent analysis is performed. Finally, the new data should be used to reevaluate all of the reach lengths and coefficients. This procedure will ensure that the modeler is always using the current flow data for the analysis.

## Model Calibration

For the high flow event, observed data were available as obtained from the USGS Atlas. Therefore the water surface profiles calculated by the model were calibrated to reflect the observed water surface profiles and weir flow. This calibration occurred after the reach lengths and coefficients had been evaluated.

From the observed data, it was recorded that a flow of approximately 3300 cfs occurred over the highway embankment. Therefore, a target value of weir flow was available for the calibration of the model. From the main menu, select **View** and then **Cross Section Table, Type**, and then **Cross Section**. Select river station 5.41 and profile 3 and this will display the table shown in Figure 2.21. In the right column, the flows in the LOB, main channel, and ROB are shown as 973.29, 10971.02, and 2055.70 cfs respectively. Since this cross section is placed immediately upstream of the bridge, the majority of the flow in the LOB and ROB will contribute to the weir flow over the bridge. From the top of the table, select **Type** and then select **Bridge**. In the left column, the weir flow is listed as being 2055.70cfs. This is the total weir flow occurring over the bridge. This value (minus the amount of weir going over the main channel) should be approximately equal to the total flow in the LOB and ROB of river station 5.41 of  $973.29 + 2061.04 = 3034.33$ . Furthermore, a target value of approximately 3300 cfs of weir flow was observed. The total weir flow was computed as being 3071 cfs, a close approximation to the estimated weir flow.

To obtain this close approximation, the weir flow coefficient was set to a value of 2.6 to account for the inefficiency of the bridge surface structure to act as a true weir and since the depth of water over the bridge was small compared to the height of the weir. Additionally, the Manning's n values were adjusted. Originally, the Manning's n values were the average values obtained from the USGS Atlas. Then, the Manning's n values were raised slightly in the overbank and main channel areas to decrease the amount of conveyance in these areas. This caused the water surface profile and the amount of weir flow to closer approximate the observed data throughout the river reach. It should be noted that the n values were raised on a global scale. Individual specific n values should not be adjusted without taking into account the spatial average of the factor.

For the pressure flow coefficients, the downstream water surface inside the bridge was calculated at a value slightly lower than the low cord. This implies that the program was using the sluice gate (submerged inlet only) pressure flow relationship. Therefore, the submerged inlet coefficient was reduced to decrease the amount of flow through the bridge. This increased the upstream energy and allowed more water to flow over the bridge to concur with what happened during the observed event.

Plan: PressWeir New Beaver Creek Kentwood RS: 5.41 Profile: May '74 flood

Element	Left OB	Channel	Right OB
E.G. Elev (ft)	217.67		
Vel Head (ft)	0.36		
W.S. Elev (ft)	217.31		
Crit W.S. (ft)	212.24		
E.G. Slope (ft/ft)	0.000974		
Q Total (cfs)	14000.00		
Top Width (ft)	1845.97		
Vel Total (ft/s)	1.60		
Max Chl Dpth (ft)	14.61		
Conv. Total (cfs)	448663.4		
Length Wtd. (ft)	30.00		
Min Ch El (ft)	202.70		
Alpha	9.02		
Frctn Loss (ft)			
C & E Loss (ft)			
Wt. n-Val.	0.300	0.040	0.250
Reach Len. (ft)	30.00	30.00	30.00
Flow Area (sq ft)	2175.39	2024.36	4557.54
Area (sq ft)	2175.39	2024.36	4557.54
Flow (cfs)	973.29	10971.02	2055.70
Top Width (ft)	448.10	197.00	1200.88
Avg. Vel. (ft/s)	0.45	5.42	0.45
Hydr. Depth (ft)	4.85	10.28	3.80
Conv. (cfs)	31191.3	351592.5	65879.7
Wetted Per. (ft)	448.29	200.25	1201.67
Shear (lb/sq ft)	0.29	0.61	0.23
Stream Power (lb/ft s)	0.13	3.33	0.10
Cum Volume (acre-ft)	40.53	42.00	197.08
Cum SA (acres)	10.49	4.93	65.40

Errors, Warnings and Notes

Note: Multiple critical depths were found at this location. The critical depth with the lowest, valid, water surface was used.

Select Profile

Figure 2-21: Cross Section Table For Plan: Press/Weir: New LeLc

Finally, for the calibration, the ineffective flow areas at cross section 5.41 and 5.39 were set to balance the flow going over the weir. Initially, the flow in the LOB and ROB at cross section 5.41 was drastically larger than the flows in the LOB and ROB at the downstream section 5.39. This was due to the fact that the ineffective flow area elevations at cross section 5.39 were previously set to a value in between the low cord and the high cord. When the flow came over the weir, the depth downstream was less than the ineffective flow elevation, so the program initially considered the overbank area as ineffective flow. This is not a realistic answer. When the flow goes over the weir it

contributes to the overbank flow at the downstream cross section and then this downstream area should be considered as effective flow. Therefore, the ineffective flow elevations were lowered to allow the weir flow that entered cross section 5.39 to become effective.

These calibrations were performed because the actual flow depths for the event were known. If these actual data were not known, then the adjustment of the Manning's n values, pressure flow coefficients, and weir flow rate could not be conducted to the refinement in the previous discussion. However, the balancing of the weir flow to the flow in the LOB and ROB at river stations 5.39 and 5.41 could be performed. The calibration to the model accounted for a more accurate determination of the water surface profile to the observed data.

## Comparison of Energy and Pressure/Weir Flow Methods to Observed Data

To compare the results of the analyses to the observed data, the observed data was first entered in the **Steady Flow Data Editor** by selecting **Options** and then **Observed WS**. This activated the editor as shown in Figure 2.22 on which the observed data were entered for the flood event. This editor was closed and then the profile plot was activated and is shown in Figure 2.23.

Figure 2.23 displays the three water surfaces for each of the two plans, as well as the observed values. The display options for this figure were selected under the **Options** menu as: 1) **Variables** - select to display the water surface and observed water surface; 2) **Profiles** - select 1,2, and 3; and 3) **Plans** - select both the "Energy Method: New Le Lc " plan and the "Pressure/Weir Flow: New Le Lc" plan. As shown in the figure, both methods produced the same water surface profiles for the first two flows (both of the low flows). This is as would be expected because both methods analyzed the two low flows using the same criteria. For the high flow, the water surface profile for the energy method and the pressure/weir flow method varied slightly upstream of the bridge. The **Zoom** feature under the **Options** menu can be used to obtain a closer view of the profiles.

Observed Water Surfaces for Comparison

River:  Add Multiple... Delete Row

Reach:  River Sta.:  Add an Obs. WS Location

Observed WS Location					Observed Water		
	River	Reach	RS	Dn Dist	25 yr	100 yr	May '74 flood
1	Beaver Creek	Kentwood	5.99	0			220
2	Beaver Creek	Kentwood	5.875*	0			219.2
3	Beaver Creek	Kentwood	5.76	0			218.4
4	Beaver Creek	Kentwood	5.685*	0			218.3
5	Beaver Creek	Kentwood	5.61	0			218.1
6	Beaver Creek	Kentwood	5.49*	0			217.9
7	Beaver Creek	Kentwood	5.41	0			217.8
8	Beaver Creek	Kentwood	5.39	0			215.2
9	Beaver Creek	Kentwood	5.24*	0			214.6
10	Beaver Creek	Kentwood	5.13	0			213.6
11	Beaver Creek	Kentwood	5.065*	0			212.5
12	Beaver Creek	Kentwood	5.0	0			211.8

OK Cancel Help

Figure 2-22: Observed Water Surface Editor

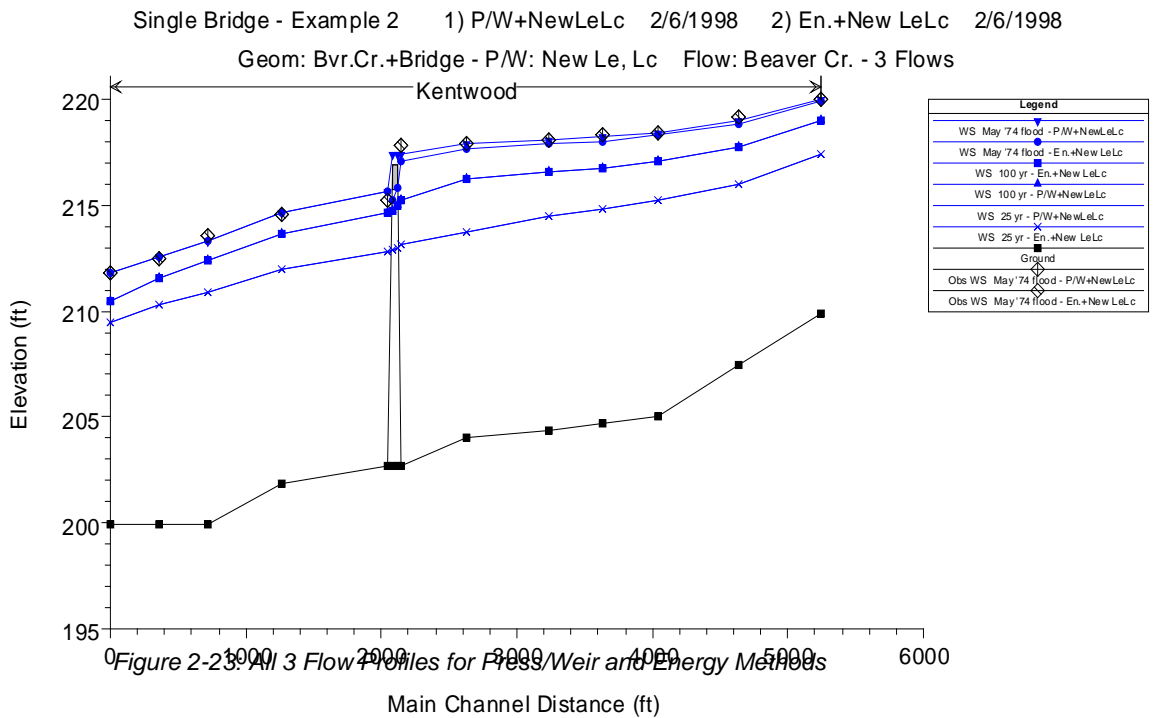

Table 2.2 shows a tabular comparison of the calculated water surface elevations for both the pressure/weir flow method and the energy method to the observed data. The observed values with a \*\* denote that the value may be in question due to there being only a few observed values in the vicinity of the location on the atlas or because those that were provided were not in the active flow area.

In comparison of the calculated values to the observed values, both of the modeling approaches were able to predict the actual water surface elevations within a reasonable tolerance. The largest errors occurred where the observed water surface values are in question. Additionally, the observed values in the table are an average water surface elevation over the area of effective flow where the cross sections are located. The one dimensional model can only predict one resulting water surface; therefore, the fluctuations across the cross section will not occur in the model as they did during the actual event.

In comparison of the pressure/weir method to the energy method, the greatest difference occurs at the bridge structure. The water surface elevations for the pressure/weir flow method inside the bridge are estimated using the upstream and downstream flow depths.

Table 2-2: Comparison of Water Surface Elevations for Q = 14000 cfs

Cross Section	Pressure/Weir		Energy		Observed
	Calculated	Absolute Error	Calculated	Absolute Error	
5.99	220.02	0.02	219.98	-0.02	220.0
5.875*	219.04	-0.16	218.94	-0.26	219.2**
5.76	218.53	0.13	218.39	-0.01	218.4
5.685*	218.31	0.01	218.15	-0.15	218.3
5.61	218.18	0.07	218.00	-0.10	218.1
5.49*	218.00	0.10	217.80	-0.10	217.9
5.41	217.31	-0.49	217.04	-0.76	217.8**
5.40 - Br Up	217.31		215.92		NA
5.40 - Br Dn	217.31		215.38		NA
5.39	215.65	0.45	215.65	0.45	215.2**
5.24*	214.64	0.04	214.64	0.04	214.6
5.13	213.33	-0.27	213.33	-0.27	213.6
5.065	212.54	0.04	212.54	0.04	212.5
5.00	211.80	0.00	211.80	0.00	211.8

## Summary

This example demonstrated the use of HEC-RAS to analyze a river reach that contains a single bridge crossing. The geometric data consisting of the cross sections and bridge geometry were entered for the reach along Beaver Creek, as obtained from the USGS Atlas No. HA-601. Three flow values were used for the analysis, with the largest flow coinciding with the flood event in May 1974. The first plan consisted of the geometry data (with the high flow method selected as press/weir) and the flow data. A second plan was created with the selection of the energy method for the high flow analysis. Review of results for these plans reflected the necessity for adjustments to the expansion and contraction reach lengths.

After the adjustments were made, two new plans were created, one for the pressure/weir and one for the energy method for the high flow analysis. The results of these two new plans were then compared to the observed water surface elevations. From the comparison, the pressure/weir method resulted with the closest values to the observed water surface elevations.





## CHAPTER 3

# Single Culvert (Multiple Identical Barrels)

### Purpose

This example is designed to demonstrate the use of HEC-RAS to analyze the flow of water through a culvert. The program has the capability of analyzing flow through a single culvert, multiple identical culverts, and multiple non-identical culverts.

A culvert type is defined by the characteristics of: shape, size, chart, scale number, length, Manning's n value, loss coefficients, and slope (upstream and downstream inverts). If a series of culverts are of the same type (have identical characteristics), then the user can combine these culverts to be categorized as one culvert ID with multiple identical barrels. For a given culvert ID, the program can analyze up to 25 identical barrels. This example will analyze a single culvert type with two identical circular barrels.

The entering of data and the analysis of a culvert are very similar to the procedures used for bridges. The user is referred to Example 2 for the procedures of bridge analyses and to Chapter 6 of the **Hydraulic Reference Manual** for a detailed discussion on modeling culverts. To review the analysis of this example, from the main HEC-RAS window, select **File** and then **Open Project**. Go to the directory in which you have installed the HEC-RAS example data sets. From the "Applications Guide\Chapter 3 – SingleCulvert" subdirectory, select the project labeled "Twin Circular Pipe - Example 3." This will open the project and activate the following files:

Plan:	"Spring Creek Culverts"
Geometry:	"Multiple Pipe Geometry"
Flow:	"Multiple Pipe Flow Data"

### Geometric Data

To perform the analysis, the geometric data were entered first. The geometric data consists of the river system schematic, the cross section geometry, placement of the cross sections, and the culvert information. Each of these geometric data components is described in the following sections.

#### River System Schematic

From the main program window, select **Edit** and then **Geometric Data** and the river system schematic of Spring Creek will appear, as shown in Figure 3.1. A river reach was drawn and the river was labeled as "Spring Creek" and the reach was titled "Culvrt Reach." This river reach was initially defined from the surveyed information to contain 9 cross sections, with river mile 20.535

### Example 3 Single Culvert – Single Bridge

as the upstream cross section and river mile 20.000 as the downstream cross section. The river station 20.208\* was interpolated for this example, and will be discussed in a subsequent section. Additionally, a culvert is displayed which was inserted at river station 20.237 during the procedure of this example.

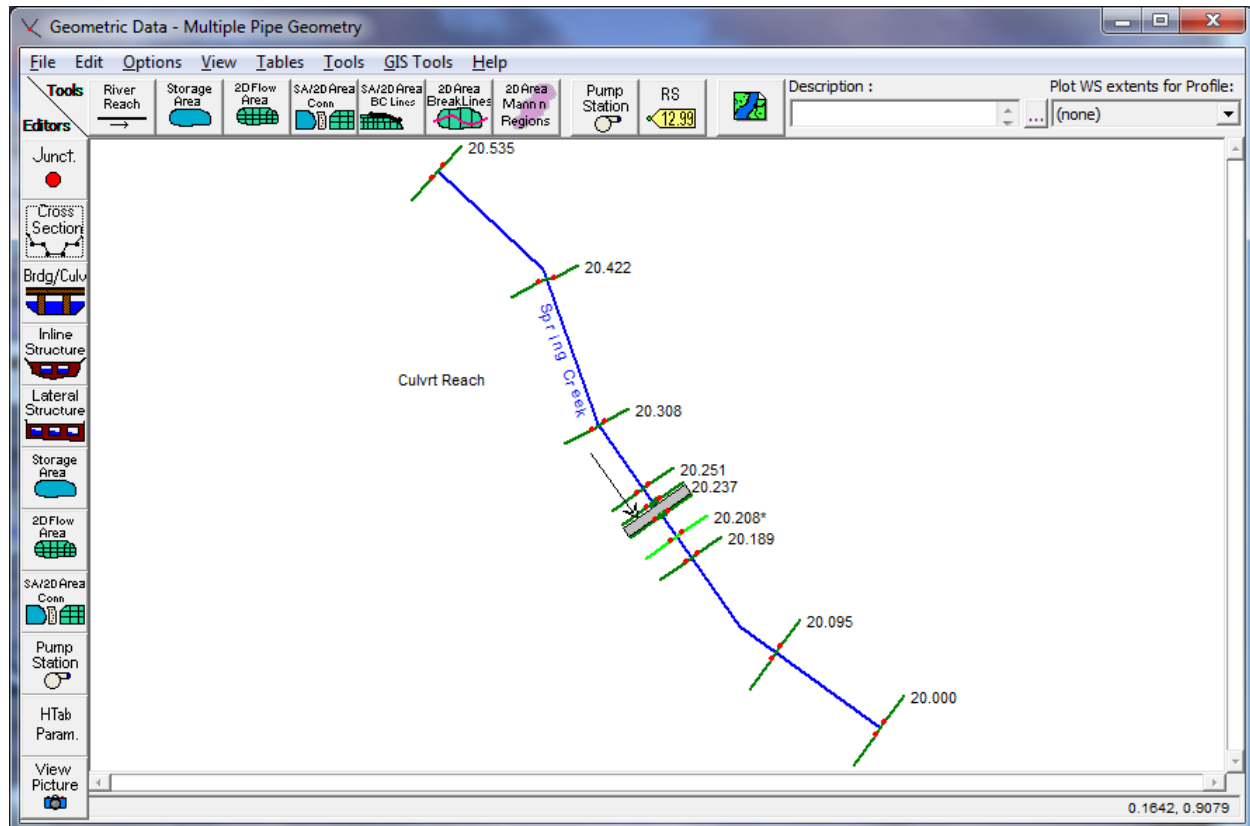

Figure 3-1: River System Schematic For Spring Creek

### Cross Section Geometry

To enter the cross section data, from the **Geometric Data Editor**, the **Cross Section** icon was selected. This activated the **Cross Section Data Editor**, as shown in Figure 3.2 for river station 20.238. A description of the section was entered as "Upstream end of Culvert" and the X-Y coordinates were entered in the table on the editor. On the right side of the editor, the reach lengths to the next downstream section (cross section 20.227 for this example) were entered as 57 feet for the LOB, main channel, and ROB. For this cross section, the **Horizontal variation in n values** was selected from the **Options** menu. This created an additional column in the X-Y coordinates section in which the Manning's n values were entered at the locations along the width of the cross section where the n values change. For this specific cross section, the n values only changed at the left and right over bank locations. Therefore, this horizontal variation option was not necessary. The n values could have been entered directly on the right side of the data editor in the LOB, Channel, and ROB fields. This option was merely selected to display this possibility.

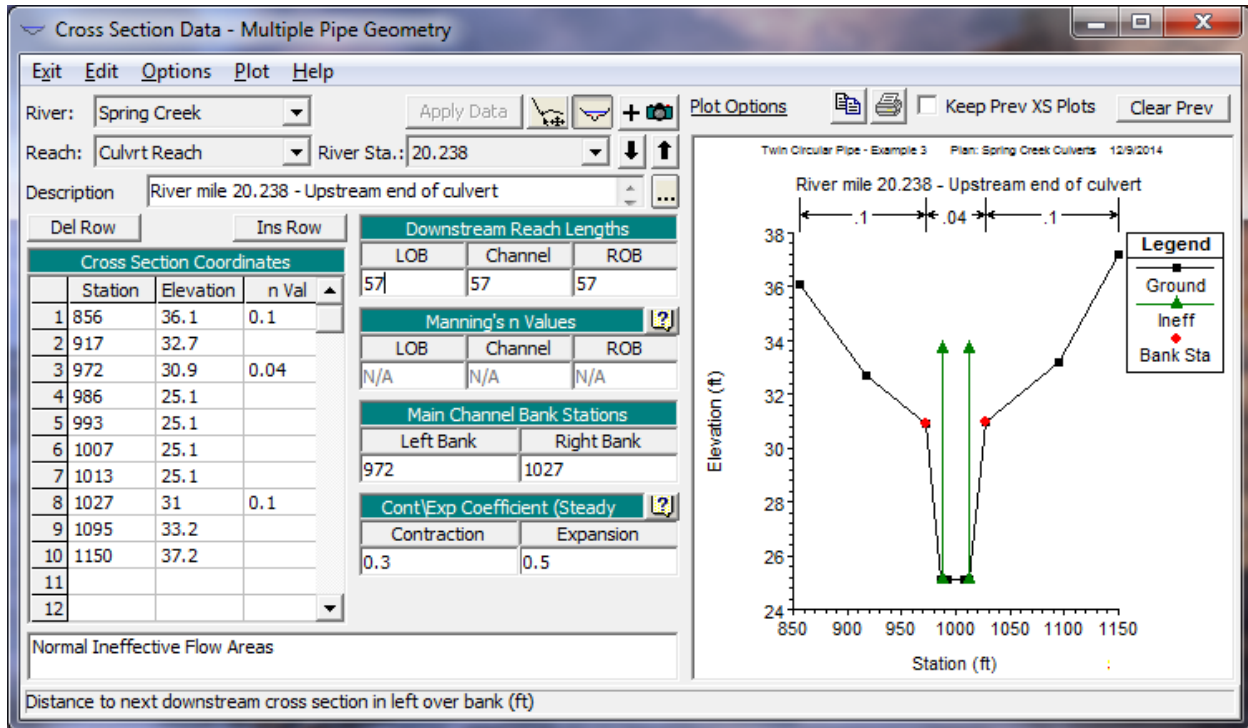

Figure 3-2: Cross Section Data Editor

Additionally, on the right side of the data editor, the left and right stations of the main channel were entered. For this cross section, the left side of the main channel is defined to start at station 972 and end at the right station of 1027 feet. Finally, the contraction and expansion coefficients were entered as 0.3 and 0.5, respectively. These coefficients are used by the program to determine the energy losses due to the flow contracting or expanding as it travels from one cross section to the next. Typical values of these coefficients for gradual transitions are 0.1 and 0.3 for contractions and expansions, respectively. However, at locations where there are sudden changes in the cross section geometry (i.e., flow into or out of a culvert or bridge opening), the coefficients may take larger values. The selection of these coefficients is discussed in detail in Chapter 3 of the **Hydraulic Reference Manual**. For this cross section (being the section immediately upstream of the culvert opening), the coefficients were initially selected as 0.3 and 0.5 for the contraction and expansion, respectively. After the flow analysis, ranges for these values were determined by using the methods outlined in the HEC-1995 research document. These ranges were compared to the selected values and will be discussed near the end of this example.

The cross-section information for the other river stations were entered in a similar fashion as for river station 20.238. Finally, the ineffective flow areas of the cross sections were entered. This option allows the user to define areas of the cross section that will contain water but the water is not flowing in the downstream direction. This option is typically used at cross sections in the vicinity of a culvert or bridge. For this example, the ineffective flow option was used at river station 20.238 (located immediately upstream of the culvert) and at river station 20.227 (located immediately downstream of the culvert).

From the **Cross Section Data Editor**, select **River Station 20.238**, **Options**, and then **Ineffective Flow Areas**. This will display the

**Ineffective Flow Editor** shown in Figure 3.3. River station 20.238 was surveyed at a location 5 feet upstream from the culvert. Typically, the stationing of the ineffective flow areas are set on a 1:1 ratio to the distance from the opening. When the culvert data are entered, the centerline stations of the two culverts will be 996 and 1004 feet and each culvert will be 6 feet in diameter. Therefore, the left edge of the opening is at station 993 and the right edge is at station 1007. Using the 1:1 ratio, the left ineffective flow station was set to be equal to 5 feet left of the left opening. Similarly, the right ineffective flow station was set to be equal to 5 feet right of the right side of the openings. These values were entered as 988 and 1012 feet for the left and right stations, respectively. Finally, the elevation of the ineffective flow area was set to be equal to 33.7 feet, a value slightly lower than the high cord on the upstream side of the roadway. Similarly, ineffective flow areas were set at cross section 20.227 at stations of 991 and 1009 (since this cross section was only 2 feet downstream of the culvert outlet) and at an elevation of 33.3 feet. The location of these ineffective flow areas will be discussed further during the analysis of the output. Typically, the culvert information may be entered first and then the modeler can enter the location of the ineffective flow areas more readily with the location of the culverts known.

### Cross Section Placement

From the Geometric Data Editor, select Tables and then Reach Lengths. This will display the table shown in Figure 3.4. Figure 3.4 displays the initial placement of the cross sections as obtained from the field data available for the analysis. (The figure does not show the inclusion of river station 20.208\* which will be added subsequently.)

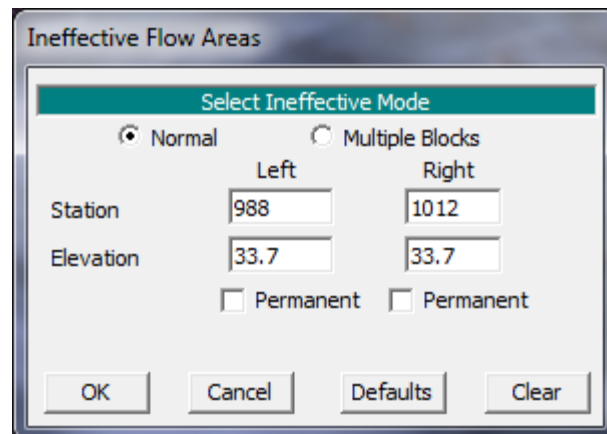

Figure 3-3: Ineffective Flow Editor at River Station 20.238

**Edit Downstream Reach Lengths**

River:      Edit Interpolated XS's

Reach:

Selected Area Edit Options

	River Station	LOB	Channel	ROB
1	20.535	650	600	500
2	20.422	650	600	500
3	20.308	300	300	350
4	20.251	70	70	70
5	20.238	57	57	57
6	20.237	Culvert		
7	20.227	100	100	100
8	20.208*	100	100	100
9	20.189	600	500	550
10	20.095	500	500	450
11	20.000	0	0	0

Figure 3-4: Reach Lengths Table For Spring Creek

The placement of the cross sections relative to the location of the culvert is crucial for accurate prediction of expansion and contraction losses. The culvert routine (as does the bridge routine) utilizes four cross sections specifically located on both sides of the structure to determine the energy losses through the culvert. (Additionally the program will interpret two cross sections inside of the culvert by superimposing the culvert and roadway data onto both the immediate downstream and immediate upstream cross sections from the culvert.) The following is a brief summary for determining the locations of the four cross sections. This procedure is identical to the procedure used for determining the cross section locations for a bridge analysis. The modeler should review the discussion in Chapter 6 of the **User's Manual** and Chapter 6 of the **Hydraulic Reference Manual** for further discussion.

**First Cross Section.** Ideally, the first cross section should be located sufficiently downstream from the culvert so that the flow is not affected by the structure (i.e., the flow has fully expanded). This distance, referred to as the expansion length ( $L_e$ ), should be determined by: field investigation during high flows; the procedure outlined in a recent study by the USACE [HEC-1995]; or other acceptable procedure. For this example, the criteria developed by USACE [HEC-1995] research document was utilized to determine the expansion reach length. To utilize this method, an initial length was estimated from values obtained in tables that are presented in the document and provided in Appendix B of the **Hydraulic Reference Manual**. Then, after the flow analysis was completed, the location was evaluated based on equations developed from the research. (This evaluation will be discussed near the end of this example.)

### Example 3 Single Culvert – Single Bridge

---

First, the following criteria were required to determine the location of the first cross section:

$$n_{ob} / n_c = 0.1 / 0.04 = 2.5$$

$$b/B = 14/145 = 0.10$$

$$S = (0.20/200) \cdot 5280 = 5.28 \text{ ft / mile}$$

$$L_{obs} = [(993 - 925) + (1070 - 1007)] / 2 = 70 \text{ ft.}$$

where: $n_{ob}$	=	Manning's n value for the overbank at cross section 20.251
$n_c$	=	Manning's n value for the main channel at cross section 20.251
$b$	=	culvert opening width, ft (m)
$B$	=	total floodplain width, ft (m)
$S$	=	slope, ft/mile
$L_{obs}$	=	average length of the side obstruction, ft

Substitution of the field data yields the results as shown above. With these values, the expansion ratio (ER) was determined to range from 0.8 to 2.0 from Table B-1 in Appendix B of the **Hydraulic Reference Manual**. The expansion ratio (ER), is the length of expansion (Le) divided by the average length of obstruction (Lobs). For this example, an average value of 1.4 was initially used for the expansion ratio. Therefore, the expansion reach length will be the expansion ratio times the average length of obstruction:

$$L_e = (ER)(L_{obs}) = (1.4)(70) = 100 \text{ ft}$$

From the initial values of the cross section locations, the expansion reach length is the distance from cross section 20.227 to 20.189. This distance is initially set at 200 feet. From the above analysis, it was determined that the distance should be approximately 100 feet. Therefore, an additional cross section was placed 100 feet downstream from cross section 20.227.

To produce this cross section, field data should be utilized. If this data is not available, then the program has the ability to interpolate a cross section. From the **Geometric Data Editor, Tools, XS Interpolation**, and then **Between 2 XS's** were selected. "Culvrt Reach" was selected as the river reach (the only reach in this example) and river station 20.227 was entered as the upper river station (this will default to river station 20.189 as being the lower river station). The maximum distance between the interpolated cross sections was set to be 100 feet and then the interpolation was performed. This resulted in the display shown in Figure 3.5. For additional information on cross section interpolation, refer to Chapter 4 of the **Hydraulic Reference Manual** and Chapter 6 of the **User's Manual**. The interpolation window was closed and the river schematic displayed the new interpolated cross section at

river station 20.208\* (as shown in Figure 3.1). The number 20.208 was the default setting since the distance chosen (100 ft) was equal to one half the previous reach length (200 ft).

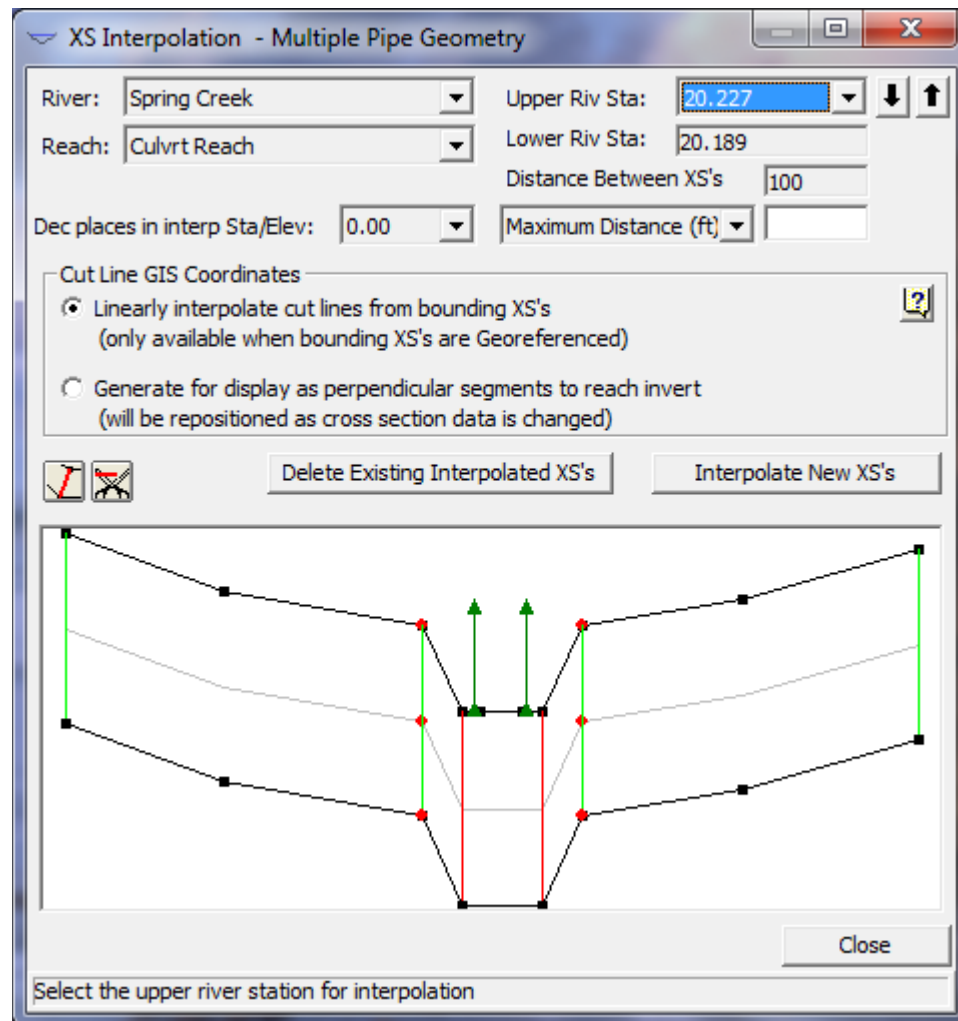

Figure 3-5: Cross Section Interpolation

After interpolating the new river station, from the **Geometric Data Editor Tables** and then **Reach Lengths** were selected. This resulted in the table shown in Figure 3.4 except that the interpolated cross-section 20.208\* appeared and the distances from cross section 20.227 to 20.208\* were 100 feet and from 20.208\* to 20.189 were also 100 feet for the LOB, channel, and ROB. The program now considered cross section 20.208\* as being the location of the fully expanded cross section.

**Second Cross Section.** The second cross section used by the program to analyze the energy losses through the culvert is located within a few feet downstream of the structure. This section should be close to the culvert (within a few feet) and reflect the effective flow area on the downstream side of the culvert. Therefore, any ineffective flow areas outside of the flow expanding out of the culvert, should not be used for conveyance calculations. For this example, cross section 20.227 was located two feet downstream from the culvert. The ineffective flow areas were developed previously using this distance. Finally, after the culvert and roadway geometry were entered, the

program superimposed the geometry onto this cross section to develop a cross section inside the culvert at the downstream end.

**Third Cross Section.** The third cross section is located within a few feet upstream from the culvert and should reflect the length required for the abrupt acceleration and contraction of the flow that occurs in the immediate area of the opening. Similar to the second cross section, this cross section should also block the ineffective flow areas on the upstream side of the culvert. For this example, cross section 20.238 was located five feet upstream of the culvert. Similar to the second cross section, the program will superimpose the culvert geometry onto the third cross section to develop a cross section inside the culvert at the upstream end.

**Fourth Cross Section.** The fourth cross section is located upstream from the culvert where the flow lines are parallel and the cross section exhibits fully effective flow. The distance between the third and fourth cross section, referred to as the contraction reach length, can be determined by: 1) field investigation during high flows, 2) the procedure outlined in a recent study by the USACE [HEC-1995]; or 3) other acceptable procedure. For this example, the criteria developed by USACE [HEC-1995] research document was utilized to determine the contraction reach length. To utilize this method, an initial length was estimated from values obtained in Table B.2 in Appendix B of the **Hydraulic Reference Manual**. To use this method, the following criteria were necessary:

$$n_{ob} / n_c = 0.1 / 0.04 = 2.5$$

$$S = 0.20 / 200 \cdot 5280 = 5.28 \text{ ft / mile}$$

where the variables are as described previously. Substitution of the values yields the results as shown above. With these values, the contraction ratio (CR) was determined to range from 0.8 to 1.5 from Table B-2. The contraction ratio is the length of contraction ( $L_c$ ) divided by the average length of obstruction. For this example, an average value of 1.15 was used for the contraction ratio. Therefore, the contraction reach length will be the contraction ratio times the average length of obstruction:

$$L_c = (CR)(L_{obs}) = (1.15)(70) = 80 \text{ ft.}$$

From the initial values of the cross section locations, the contraction reach length is the distance from cross section 20.251 to 20.238. This distance was initially set at 70 feet. From the above analysis, it was determined that the distance should be approximately 80 feet. Because these values are so close together, the initial value of 70 feet will be maintained. Finally, after the flow analysis was performed, the location of this cross section was evaluated and will be discussed near the end of this example.

### Culvert Data

From the **Geometric Data Editor**, the **Bridge/Culvert** icon was selected. This activated the **Bridge Culvert Data Editor**. To enter the culvert data, **Options** and then **Add a Bridge and/or Culvert** were first selected. The location for the culvert was entered as 20.237. Then, the bounding river stations (20.227 and 20.238) appeared on the **Bridge Culvert Data Editor**.



Next, the deck/roadway data and then the culvert geometric data were entered. Each of these are discussed in the following sections.

**Deck/Roadway Data.** To enter the data for the deck/roadway, the **Deck/Roadway** icon on the left side of the **Bridge Culvert Data Editor** was selected. This activated the **Deck/Roadway Data Editor** as shown in Figure 3.6. Along the top row of the deck/roadway data editor, the user must first enter the distance from the upstream side of the deck/roadway to the cross section that is placed immediately upstream of the culvert (cross section 20.238 for this example). This distance was set at 10 feet. The next field is the width of the roadway. For this example, this distance was 40 feet. The program will then add the 10 feet and the 40 feet to obtain 50 feet as the distance from cross section 20.238 to the downstream end of the deck/roadway. From the cross section geometric data, the distance from cross section 20.238 to 20.227 was 57 feet. This allowed for 7 feet of distance from the downstream side of deck/roadway to cross section 20.227.

The final field along the top row is the weir coefficient. This coefficient is used when the flow overtops the roadway and weir flow occurs. For this example, a value of 2.6 was selected as the weir coefficient for the roadway. This value may be changed to account for the shape of the roadway and the degree of obstructions along the edge of the roadway. Additional information on weir flow is presented in Chapter 6 of the **Hydraulics Reference Manual**.

Figure 3-6: Deck/Roadway Data Editor

The central portion of the editor consists of fields to enter the stations and elevations of the deck/roadway. The values for this example are as shown in

the figure. If the upstream and downstream decking is identical, then the user needs to only enter the upstream information and then select **Copy Up to Down**. (Note: For culverts, only the high cord information is required. The program will automatically block out the area between the high cord and the ground. For a bridge analysis, the low cord information is required to define the bridge opening. For a culvert analysis, the culvert data will define the openings below the high cord for the locations of the culverts.)

The next two fields are the **US and DS Embankment Side Slopes**. These values were entered as 2 (horizontal to 1 vertical). For a culvert analysis, these values are only used for the profile plot.

The bottom of the editor consists of three additional fields. The first field is the **Maximum Allowable submergence** ratio. This is the ratio of downstream flow depth to upstream energy, as measured from the minimum high cord of the deck. When this ratio is exceeded for a bridge analysis, the program will switch from the weir flow equation to the energy method to determine the upstream flow depth. For a culvert analysis, this ratio is not used because the program cannot perform a backwater analysis through a culvert flowing full. Therefore, the weir analysis method will always be used when overflow occurs.

The second field is the **Minimum Weir Flow Elevation**. This is the elevation that the program uses to determine when weir flow will begin. If this field is left blank, the program will use the lowest value of the high cord on the upstream side of the deck. Alternatively, the user can enter a value for the program to start checking for the possibility of weir flow. For this example, an elevation of 33.7 feet was used. This is the elevation of the roadway above the culvert openings on the upstream side of the culvert. (Note: This is also the minimum elevation of the high cord and therefore, this field could have been left blank.)

Finally, the last field requires the selection of the weir crest shape: broad crested or ogee shaped. This selection is used for the type for submergence correction. For this example, a broad crested weir shape submergence correction was used. With all of the data entered, the **OK** button was selected to exit the **Deck/Roadway Data Editor**.

**Culvert Geometric Data.** To enter the culvert geometric data, from the **Bridge Culvert Data Editor**, the **Culvert** icon was selected. This activated the **Culvert Data Editor** as shown in Figure 3.7. Each of the fields for the editor are described in the following sections.

*Culvert ID* - By default, the identifier for the first culvert will be set to "Culvert #1." A culvert type is defined by the shape, diameter (or rise and span), chart number, scale, length, n value, loss coefficients, upstream invert, and downstream invert. If all of these parameters are the same for each culvert, then the modeler will only have one culvert type. Then the modeler can enter up to 25 identical barrels for this culvert type, with each barrel occurring at a different location (defined by the upstream centerline and downstream centerline). If any of the culvert parameters change, then the modeler must define each culvert that is different as a separate type (to a maximum of 10 culvert types at the same river station), with each type containing up to 25 identical barrels. For this example, the culvert consisted of only 1 culvert type (since all of the parameters were the same for each barrel) but it

contained two identical barrels (with each placed at separate upstream and downstream centerline locations).

*Solution Criteria* - The user has the option to select to use the result for inlet control or outlet control as the final answer for the upstream energy grade line value. The default method is to use the highest of the two values, as was selected for this example.

*Shape* - The culvert shape is chosen from the eight available shapes: circular, box, elliptical, arch, pipe arch, semi-circle, low arch, or high arch. For this example, the culvert barrels were circular shape. To select the shape, press the down arrow on the side of the shape field and highlight the desired shape.

Centerline Stations		
	Upstream	Downstream
1	996.	996.
2	1004.	1004.
3		
4		

Figure 3-7: Culvert Data Editor

*Diameter, Rise, or Rise and Span* - Depending on the shape of the culvert, the modeler must enter the inside dimensions of the culvert. For a circular pipe, only the diameter is required. For other shapes, the rise is defined as the inside vertical measurement and the span is the inside horizontal measurement. (Note: For box culverts with chamfered corners, refer to the discussion in Chapter 6 of the **Hydraulic Reference Manual**.) For this example, the circular culvert was set to have a diameter of 6 feet.

*Chart #* - Each culvert type and shape is defined by a Federal Highway Administration Chart Number. Depress the down arrow next to this field to select the appropriate chart number. Once a culvert shape has been selected, only the corresponding chart numbers available for that culvert shape will appear in the selections. Descriptions for the chart numbers appear in Chapter 6 in the **Hydraulic Reference Manual**. For this example, the culvert chart was selected as "1 - Concrete Pipe Culvert."

*Scale* - This field is used to select the Federal Highway Administration scale that corresponds to the selected chart number and culvert inlet shape. Only the scale numbers which are available for the selected chart number will appear for selection. Descriptions for the scale numbers appear in Chapter 6 in the **Hydraulic Reference Manual**. The scale for this example was "1 - Square edge entrance with head wall."

*Distance to Upstream XS* - This is the distance from the inlet of the culvert to the upstream cross section (20.238). For this example, this was a distance of 5 feet. On the **Deck/Roadway Data Editor**, a measure of 10 feet was entered for the distance from the upstream side of the deck/roadway to the upstream cross section. Therefore, the culvert entrance is located midway between the upstream side of the roadway and cross section 20.238.

*Length* - This field is the measure of the culvert (in feet or meters) along the centerline of the barrel. The length of the culvert for this example was 50 feet. The program will add this 50 feet to the 5 foot distance from cross section 20.238 (to the culvert entrance) and obtain 55 feet. The reach length from cross section 20.238 to 20.227 is 57 feet, which leaves 2 feet from the exit of the culvert to the downstream cross section.

*Entrance Loss Coefficient* - The value of the entrance loss coefficient will be multiplied by the velocity head at the inside upstream end of the culvert to obtain the energy loss as the flow enters the culvert. Typical values for the entrance loss coefficient can be obtained from Tables 6.3 and 6.4 in the **Hydraulic Reference Manual**. The entrance loss coefficient for the concrete pipe in this example was set at 0.5.

*Exit Loss Coefficient* - To determine the amount of energy lost by the water as it exits the culvert, the exit loss coefficient will be multiplied by the difference of the velocity heads from just inside the culvert at the downstream end to the cross section located immediately downstream of the culvert exit. In general, for a sudden expansion, the exit loss coefficient should be set equal to 1. However, this value may range from 0.3 to 1.0. For this example, the exit loss coefficient was set to be equal to 1.0.

*Manning's n for Top* - This field is used to enter the Manning's n value of the top and sides of the culvert lining and is used to determine the friction losses through the culvert barrel. Suggested n values for culvert linings are available in many textbooks and also may be obtained from Table 6.1 in the **Hydraulic Reference Manual**. Roughness coefficients should be adjusted according to individual judgment of the culvert condition. For this example, a Manning's n value of 0.013 was used for the concrete culvert.

*Manning's n Value for Bottom* – This field is used to enter the Manning's n value of the bottom of the culvert. For most culverts, this field will be the same as the Manning's n value for the top. However, if the culvert has a natural bottom, or something has been placed in the bottom for fish passage, the n value may vary.

*Depth to use Bottom n* – This field is used to enter a depth inside of the culvert that the bottom n value is applied to. If the bottom and top n value are the same, a value of zero should be entered.

*Depth Blocked* – This field is used to fill in a portion of the culvert. The user enters a depth, and everything below that depth is blocked out.

*Upstream and Downstream Invert Elevation* - These two fields are used to enter the elevations of the inverts. For a particular culvert type, all of the identical barrels will have the same upstream invert elevation and downstream invert elevation. For this example, the upstream invert was set at an elevation of 25.1 feet and the downstream invert was 25.0 feet.

*Centerline Stations* - This table is used to enter the stationing (X-coordinates) of the centerline of the culvert barrels. The upstream centerline is based upon the X-coordinates of the upstream cross section (20.238) and the downstream centerline is based upon the X-coordinates of the downstream cross section (20.227). This example employs two culvert barrels, with the centerline of the barrels occurring at stations 996 and 1004 feet, as measured on both cross sections. For this example, the X-coordinate geometry of both cross section 20.238 and cross section 20.227 are referenced from the same left station starting point. Therefore, the upstream and downstream centerline stations are the same value and this will align the culvert in the correct configuration as being parallel to the channel. The modeler must be cautious to ensure that the centerline stationing of the culvert ends align the culvert in the correct position.

*# Identical barrels* - This field will automatically display the number of barrels entered by the user (determined by the number of centerline stations entered). Up to 25 identical barrels can be entered for each culvert type, and this example consisted of 2 identical barrels.

This completed the necessary geometric data for the analysis. The **OK** button at the bottom of the **Culvert Data Editor** was selected and this displayed the culvert as shown in Figure 3.8. The geometry data editors were then closed and the geometry was saved as "Multiple Pipe Geometry."

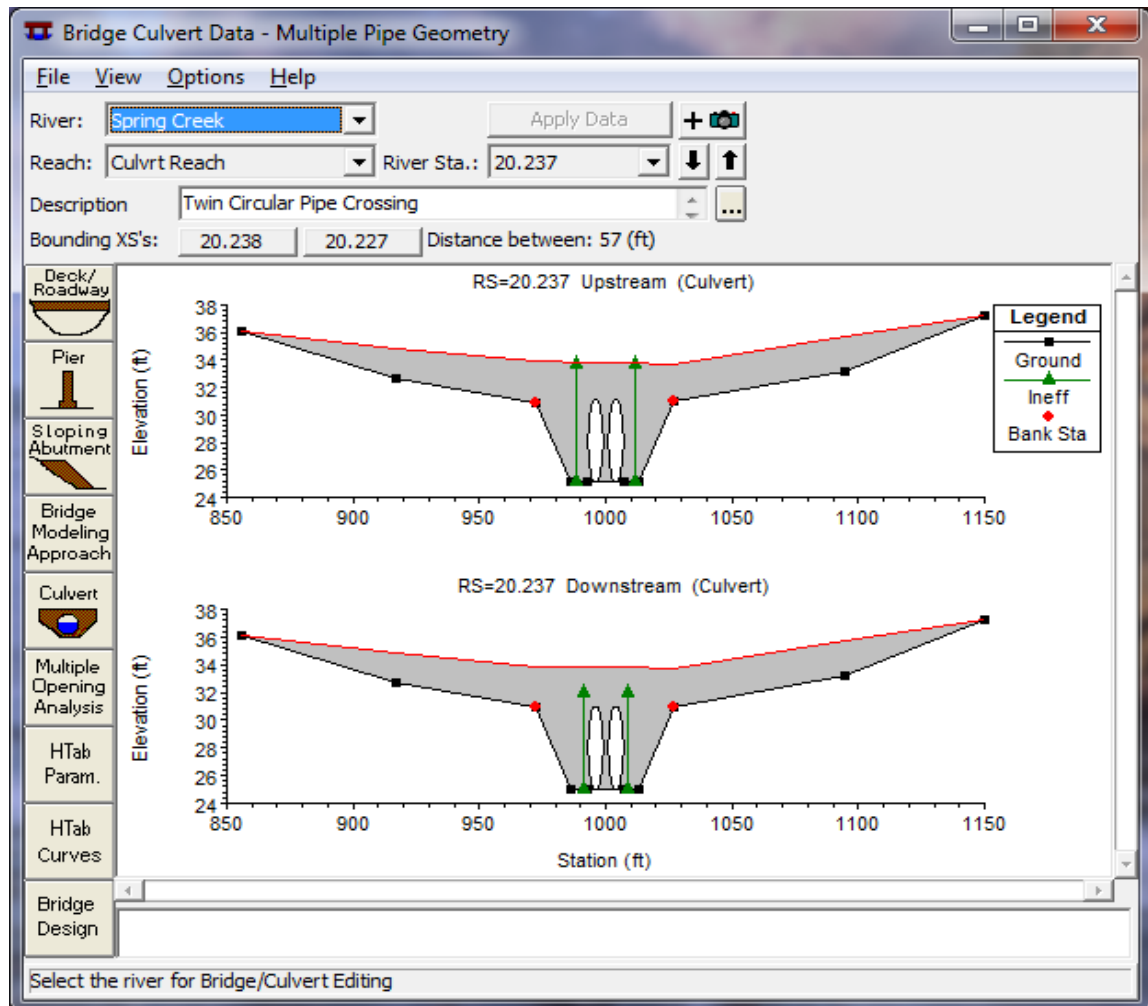

Figure 3-8: Bridge/Culvert Data Editor For Spring Creek

## Steady Flow Data

To perform the steady flow analysis through the culvert, the user must enter the flow data and boundary conditions for each flow profile. Each of these components is discussed below.

### Flow Data

To enter the flow data, from the main program window **Edit** and then **Steady Flow Data** were selected. This activated the **Steady Flow Data Editor** as shown in Figure 3.9. For this example, 3 flow profiles were computed. A value of "3" was entered as the number of profiles and the central table of the editor established three columns for the flow profiles. The flow values were then entered at the upstream river station (20.535) as the values of 250, 400, and 600 cfs. Additionally, the profile names were changed to be "5 yr," "10 yr," and "25 yr."

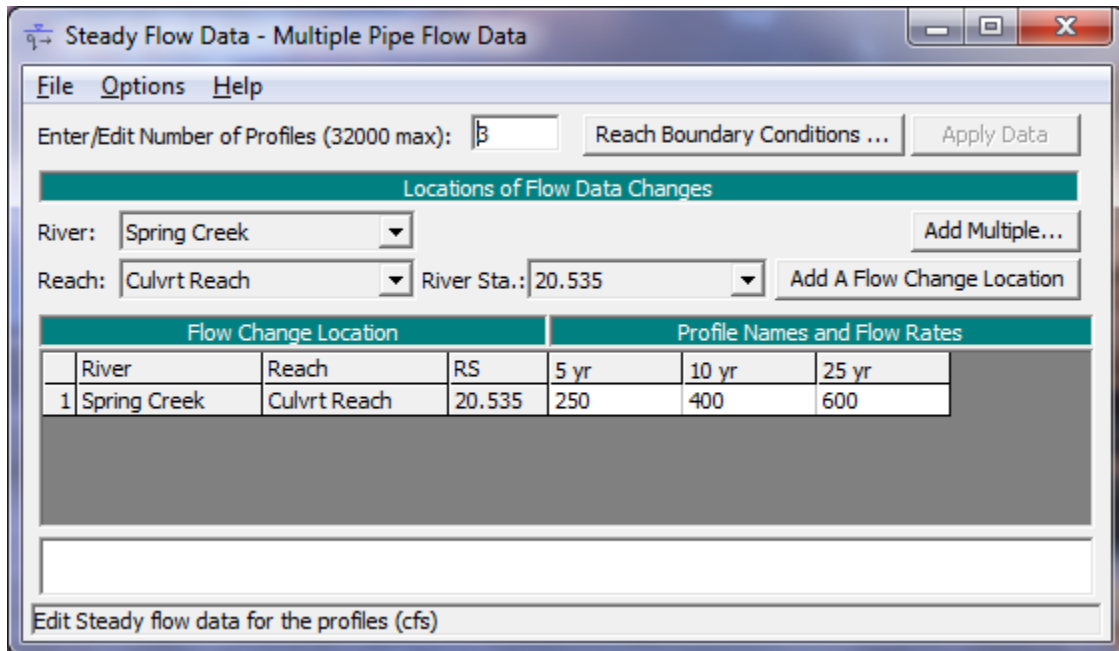

Figure 3-9: Steady Flow Data Editor

## Boundary Conditions

To enter the boundary conditions the **Boundary Conditions** icon at the top of the **Steady Flow Data Editor** was selected. This activated the **Boundary Conditions Editor** as shown in Figure 3.10. This flow analysis was performed in the subcritical flow regime. Therefore, a boundary condition was established at the downstream end of the reach for each flow profile. For a detailed discussion on the boundary conditions, the modeler is referred to Chapter 7 of the **User's Manual** and Chapter 3 of the **Hydraulic Reference Manual**. From the Boundary Conditions Data Editor, the boundary conditions were entered by first selecting the Down Stream field and then **Known W. S.** This activated the known water surface boundary condition window as shown in Figure 3.11.

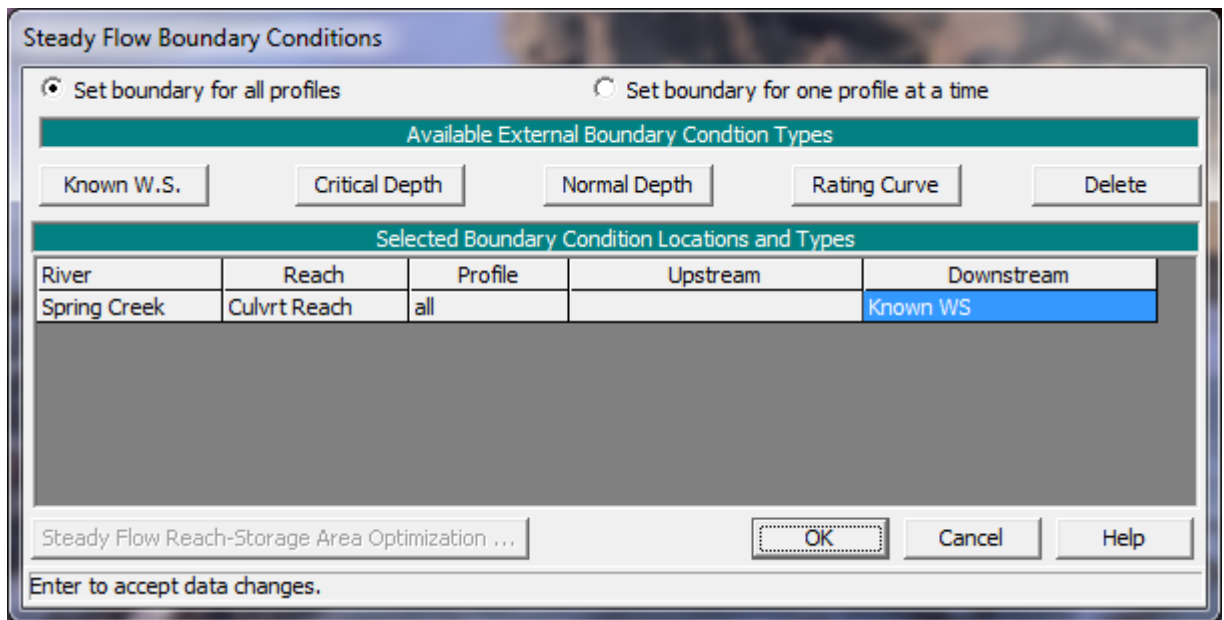

Figure 3-10: Boundary Conditions Data Editor

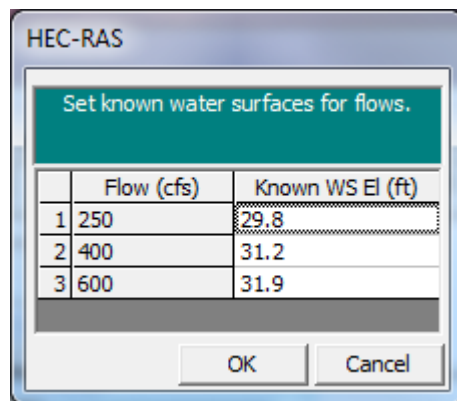

Figure 3-11: Known Water Surface Boundary Conditions

As shown in Figure 3.11, a known water surface elevation was then entered for each of the flow profiles that were computed. For this example, the known water surface elevations of 29.8, 31.2, and 31.9 were entered for the flows of 250, 400, and 600 cfs, respectively. Once the data were entered, the **OK** button was selected to exit this window. This completed the necessary steady flow data for the analysis and the data were saved as "Multiple Pipe Flow Data."



## Steady Flow Analysis

To perform the steady flow analysis, from the main program window Run and then **Steady Flow Analysis** were selected. This activated the **Steady Flow Analysis Window** as shown in Figure 3.12. A **short ID** was entered as "Base Plan" and a subcritical flow analysis was selected in the lower left corner of the editor. From the **Options** menu, the **Set Output Options** was selected and then an "x" was placed next to **Critical Always Calculated**. This will cause the program to always calculate critical depth at every cross section. This will add computational time to larger analyses; however, this will enable the user to view the critical flow depth along the river reach.

Additionally, from the **Options** menu, ensure that there is a "" adjacent to the option **Check data before execution**. With this option, the program will check to ensure that all pertinent information is present before the analysis is performed. It cannot determine the accuracy of the data. (Note: If there is a check mark next to this option, a selection of this option will remove the check mark.) Finally, the geometry file "Multiple Pipe Geometry" and the steady flow file "Multiple Pipe Flow Data" were saved as the plan "Spring Creek Culverts", with a short ID of "Base Plan." Then, the **COMPUTE** button was selected to perform the steady flow analysis.

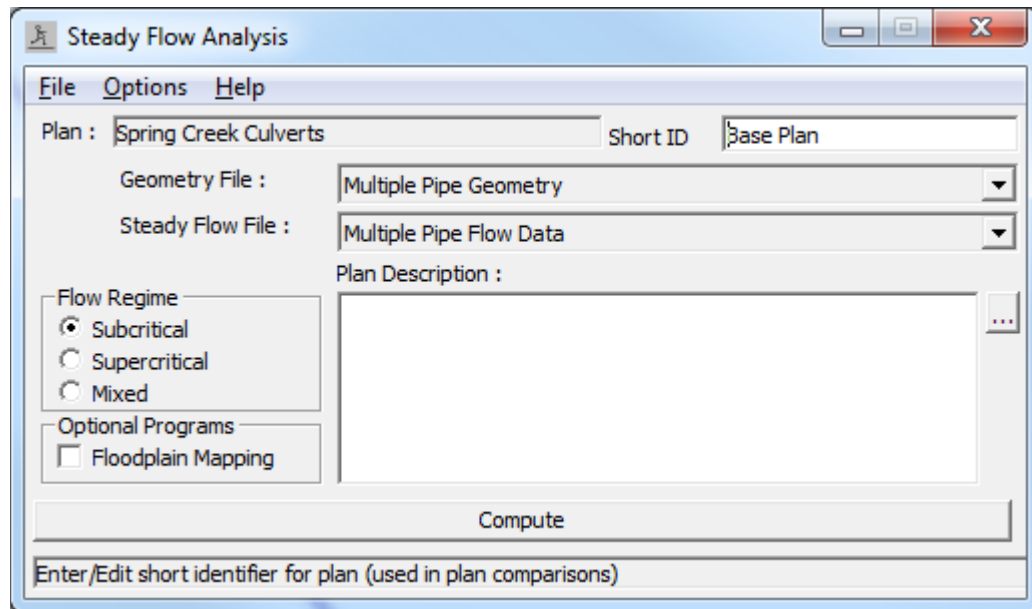

Figure 3-12: Steady Flow Analysis Window

## Output Analysis

For the analysis of the output, the modeler has various options to review the data. For this analysis, evaluations were performed for the expansion and contraction reach lengths and the channel contraction and expansion coefficients. Then, the water surface profiles were reviewed.

**Expansion and Contraction Reach Length Evaluation**

Initially the reach lengths were determined using table values obtained from the U.S. Army Corps of Engineers' research document [HEC-1995] and the cross sections 20.208\* and 20.251 were located based on these initial values. The table values provided a range and the average values were initially used. With the program output, the equations developed in the document were utilized to evaluate the locations (and reach lengths) that were selected. The modeler should be aware that the regression equations were developed based on low flow conditions for bridges and the equations may not be practical for analyses of flow through culverts.

**Expansion Reach Length.** Cross section 20.208\* was the interpolated section that was assumed to be at the location where the flow became fully expanded. To evaluate the location of this cross section, the relationship shown as Equation 3-1 was used. Equation 3-1 is applicable when the width of the floodplain and the discharge is less than those of the regression data. The equation is:

$$ER = \frac{L_e}{L_{obs}} = 0.421 + 0.485 \left( \frac{F_{20.227}}{F_{20.208*}} \right) + 0.000018Q \tag{3-1}$$

- where: ER = expansion ratio
- $L_e$  = expansion reach length, ft
- $L_{obs}$  = average length of side obstruction, ft
- $F_{20.227}$  = main channel Froude number at the cross section immediately downstream of the culvert (cross section 20.227 for this example)
- $F_{20.208*}$  = main channel Froude number at the cross section of fully expanded flow (cross section 20.208\* for this example)
- Q = total discharge, ft<sup>3</sup>/s

(Note: The subscripts used in Equation 3-1 and all subsequent equations reflect the river station numbering for this example.) From the analysis, the Froude numbers at cross sections 20.227 and 20.208\*, for the flow of 600 cfs, are 0.32 and 0.14, respectively. Substituting these values into Equation 3-1 yields an expansion ratio of 1.51. This value falls within the range of 0.8 – 2.0 as determined previously from the table values. With this new expansion ratio, the expansion reach length is:

$$L_e = (ER)(L_{obs}) = (1.51)(70) = 106 \text{ ft}$$

Additionally, the expansion ratio has a standard error of 0.26. Using the range of the ER from 1.25 (= 1.51 - 0.26) to 1.77 (= 1.51 + 0.26) yields an  $L_e$  range from 88 to 124 feet to define the 68% confidence band for Equation 3-1. The actual distance from cross section 20.227 to cross-section 20.208\* was set at 100 feet. Therefore, the existing expansion reach length seems

appropriate. If the existing length had been significantly outside of the range of the calculated expansion reach length, then a second iteration for the placement of the fully expanded cross section and an additional analysis may be warranted. As a final check, the expansion ratio should not exceed 4:1 and should not be less than 0.5:1.

**Contraction Reach Length.** Cross section 20.251 is located where the flow lines are parallel to the main channel. To evaluate this location, Equation 3-2 from the research document [HEC-1995] was utilized. This equation is used when the floodplain scale and dischargers are significantly different than those used in the regression analysis and is:

$$CR = 1.4 - 0.333 \left( \frac{F_{20.227}}{F_{20.208*}} \right) + 1.86 \left( \frac{Q_{ob}}{Q} \right)^2 - 0.19 \left( \frac{n_{ob}}{n_c} \right)^{0.5} \quad (3-2)$$

- where:  $CR$  = contraction ratio
- $L_c$  = contraction reach length
- $Q_{ob}$  = discharge conveyed by the two overbanks at cross section 20.251, cfs
- $Q$  = total discharge, cfs
- $n_{ob}$  = Manning's n value of the overbanks at cross section 20.251
- $n_c$  = Manning's n value for the main channel at cross section 20.251

From the analysis of the 600 cfs profile, the flow in the two overbanks at cross section 20.251 is 69.33 cfs and the Manning's n values for the overbanks and main channel at cross section 20.251 are 0.10 and 0.04, respectively. Substituting these values into Equation 3-2 yields a contraction ratio of 0.39. The standard error for this equation is 0.19 which yields a range of the CR from 0.20 to 0.58. From the results cited in the research document, a minimum contraction ratio is 0.3:1 and a maximum ratio is 2.5:1. The calculated average value of 0.39 is very close to the minimum value. If this value is used, the contraction reach length would be:

$$L_c = (CR)(L_{obs}) = (0.39)(70) = 27 \text{ feet}$$

This is the median value for the range of 14 to 41 feet (using CR = 0.20 and 0.58, respectively). The actual distance used for the contraction reach length (the length from river station 20.251 to river station 20.238) was 70 feet. For this example, the contraction reach length was maintained at the 70 feet value. However, an additional analysis was performed with the 27 feet contraction reach length and no appreciable difference in the water surface was observed to reflect the necessity for the change of the contraction reach length to 27 feet.

**Channel Contraction and Expansion Coefficients**

The coefficients of contraction (Cc) and expansion (Ce) are used to determine the energy losses associated with the changes in channel geometry. Initially, in the vicinity of the culvert, the coefficients were set at 0.3 and 0.5 for the contraction and expansion, respectively. Each of these values will be evaluated.

**Expansion Coefficient.** The expansion coefficient can be obtained from Equation 3-3:

$$C_e = -0.09 + 0.570 \left( \frac{D_{ob}}{D_c} \right) + 0.075 \left( \frac{F_{20.227}}{F_{20.208*}} \right) \tag{3-3}$$

- where:  $C_e$  = coefficient of expansion
- $D_{ob}$  = hydraulic depth (flow area divided by the top width) for the overbank at cross section 20.208\*
- $D_c$  = hydraulic depth for the main channel at cross section 20.208\*

From the analysis of the 600 cfs profile, the hydraulic depths for the overbanks and the main channel are 0.58 and 5.66 feet, respectively. Substitution of the values into Equation 3-3 yielded an expansion coefficient of 0.14. This is the median value and the range of ± 0.2 defines the 95% confidence band for Equation 3-3. For this example, a value of 0.5 was used. The value of the expansion coefficient is generally larger than the value used for the contraction coefficient so the value of 0.5 will remain as the selected value. The regression equation (3-3) was developed for bridges with overbank areas larger than the current example. Therefore, the data for this current example may not be within the range of data used to develop the regression equation. The modeler can perform a sensitivity of this coefficient by changing this coefficient and performing subsequent analyses. For this example, a value of 0.3 was used during a subsequent analysis and no appreciable difference was observed in the resulting water surface.

**Contraction Coefficient.** From the research document [HEC-1995], the contraction coefficient is obtained by first determining the relationship:

$$b / B = 14 / 145 = 0.10$$

- where:  $b$  = culvert opening width, ft (m)
- $B$  = total floodplain width, ft (m)

From Table B-3 of Appendix B in the **Hydraulic Reference Manual**, the recommended contraction coefficient range is 0.3 - 0.5. The value selected for this example was the minimum value of 0.3, which reflects a value in between a typical contraction and an abrupt contraction.

## Water Surface Profiles

From the main program window, select **View** and then **Water Surface Profiles**. This will result in the display shown in Figure 3.13. In the figure, the water surface elevations and the energy gradelines are shown for all three flow profiles (the variables can be selected from the **Options** menu). As can be seen in the figure, the first flow of 250 cfs was able to travel through the culvert without submerging the entrance. The second flow (400 cfs) caused the headwater and tailwater to submerge the entrance and exit of the culvert, respectively. Finally, the third flow (600 cfs) caused an overtopping of the roadway, which yielded weir flow.

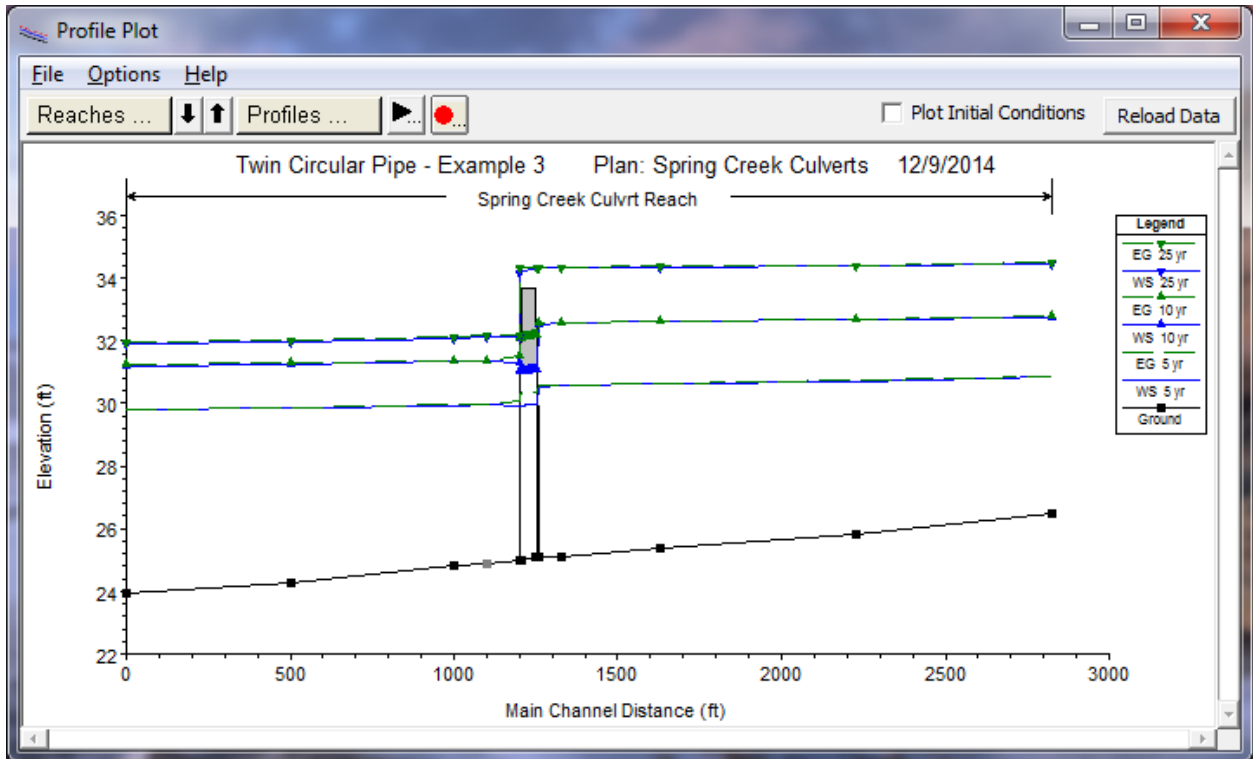

Figure 3-13: Water Surface Profiles For Spring Creek Culverts

To investigate the first flow profile, from the main window select **View**, **Cross Section Table**, **Type**, and then **Culvert**. Select the river reach of "Culvrt Reach," river station 20.237, profile 1, and culvert #1. This will display the table shown in Figure 3.14. The left column of the table shows a total flow rate of 250 cfs through the culvert. Since the culvert has two identical barrels, this yields a flow of 125 cfs through each barrel. The table also shows that the normal depth (3.56 ft) was greater than the critical depth (3.02 ft), which corresponds to subcritical flow occurring through the culvert. At the bottom of the left column, the data shows that the culvert did not flow full for any length of the culvert. Additional values such as the velocity in the culvert at the upstream and downstream ends are displayed.

Example 3 Single Culvert – Single Bridge

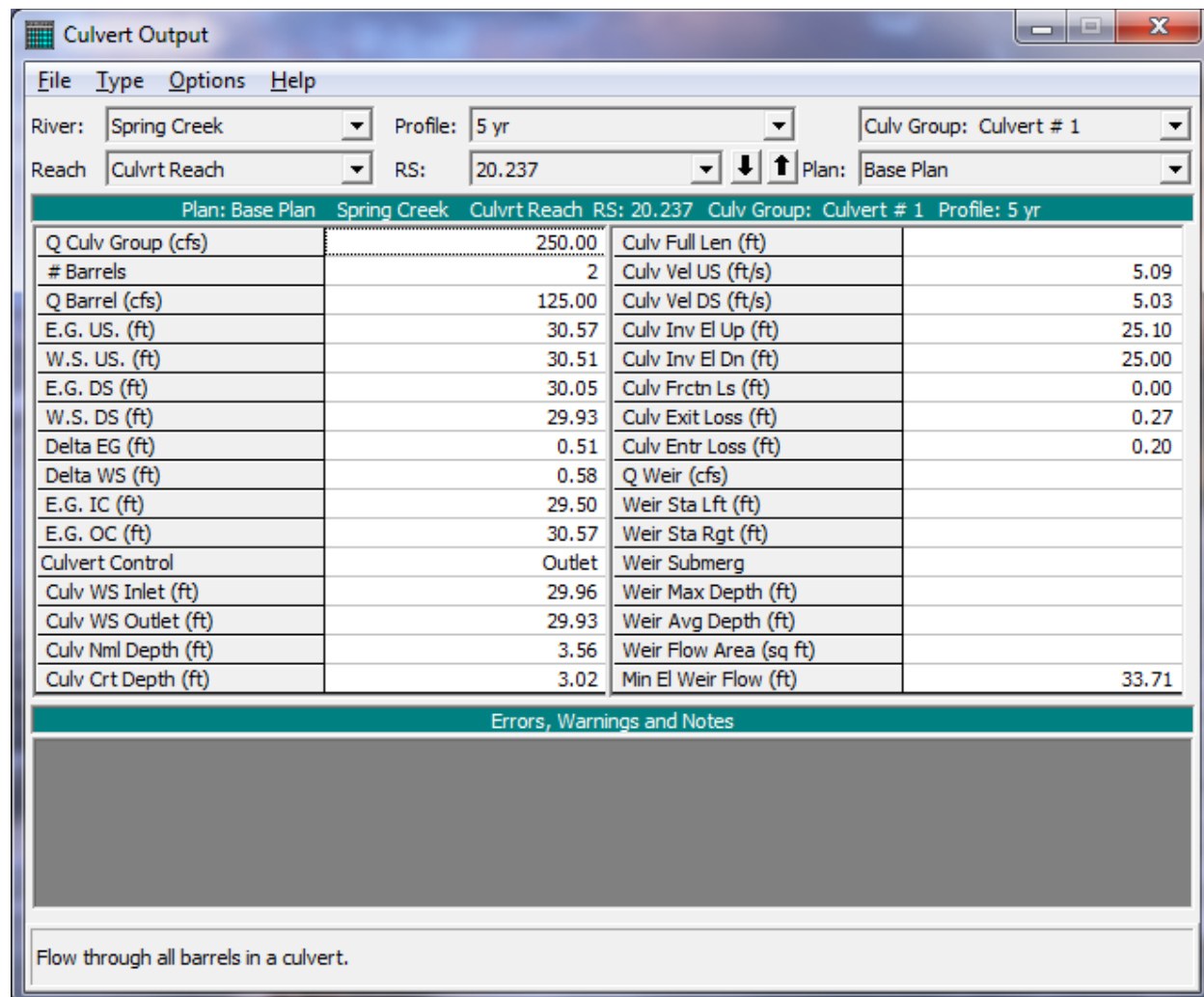

Figure 3-14: Culvert Table For Flow=250 cfs

To determine the control of flow through the culvert (i.e., inlet or outlet), the values of the upstream energy grade line necessary for inlet control (E.G. IC) and outlet control (E.G. OC) are shown in the left column of Figure 3.14. For the specified flow of 250 cfs, the upstream energy grade line for inlet control was 29.50 feet and the upstream energy grade line for outlet control was 30.57 feet. The program will select the higher of these two values to determine which type of control will occur (since "Highest Upstream EG" was selected on the **Culvert Data Editor**). For this example, outlet control occurred and the energy gradeline used by the program is listed as the energy grade line upstream of 30.57 feet. Finally, by using the values in Figure 3.14 and following the decision flow chart shown as Figure 6.9 in the **Hydraulic Reference Manual**, the modeler can determine the procedure used by the program to determine the water surface profile. For this flow of 250 cfs, the program used the Direct Step Method to calculate the water surface profile.

For an analysis of the second flow (400 cfs), a similar procedure can be followed. For this example, the second flow resulted in full flow along the entire length of the barrels of the culvert. The upstream water surface profile was determined by using the FHWA full flow equations.

For the third flow (600 cfs), the inlet and outlet were submerged and weir flow occurred over the roadway. Select the **Culvert** type **Cross Section Table** (as performed for Figure 3.14) and select the third flow profile. This will display the table shown in Figure 3.15. For this profile, the flow through the culvert was 525.75 cfs, 262.87 cfs through each identical barrel. The energy grade line upstream was calculated to be 34.34 feet, which corresponds to the outlet control energy grade line as shown.

The weir flow at river station 20.237 resulted with a value of  $600 - 525.75 = 74.25$  cfs. This occurred from an X-coordinate of 945.10 to 1048.77, a distance of 103.67 feet. The main channel bank stations for cross sections 20.227 and 20.238 are at 972 and 1027. Therefore, the weir flow from 945.1 to 972 should balance with the flow in the LOB at river stations 20.227 and 20.238. Additionally, the weir flow from 1027 to 1048.77 should balance with the flow in the ROB at river stations 20.227 and 20.238.

At river station 20.237, the amount of weir flow from 945.1 to 972 can be approximated as: the specific length of weir divided by the total weir length times the weir flow. This was calculated as:

$$(972.00 - 945.1)/(103.67) \cdot (74.25) = 19.26 \text{ cfs}$$

Similarly, the amount of weir flow from 1027 to 1048.77 is approximately 15.4 cfs. Therefore, at river stations 20.227 and 20.238, the flow in the LOB should be approximately 19.26 cfs and the flow in the ROB should be approximately 15.4 cfs.

To determine the amount of flow in the overbanks at cross section 20.227, from the **Cross Section Table** window, select **Type** and then **Cross Section**. Toggle to river station 20.227 for the third flow profile. The values for the flow in the LOB and ROB are zero at this cross section. By toggling to river station 20.238, it was observed that the flows in the LOB and ROB were 36.2 and 34.4 cfs, respectively. Therefore, these flow values in the LOB and ROB for both river stations need to be adjusted to balance with the amount of weir flow.

Example 3 Single Culvert – Single Bridge

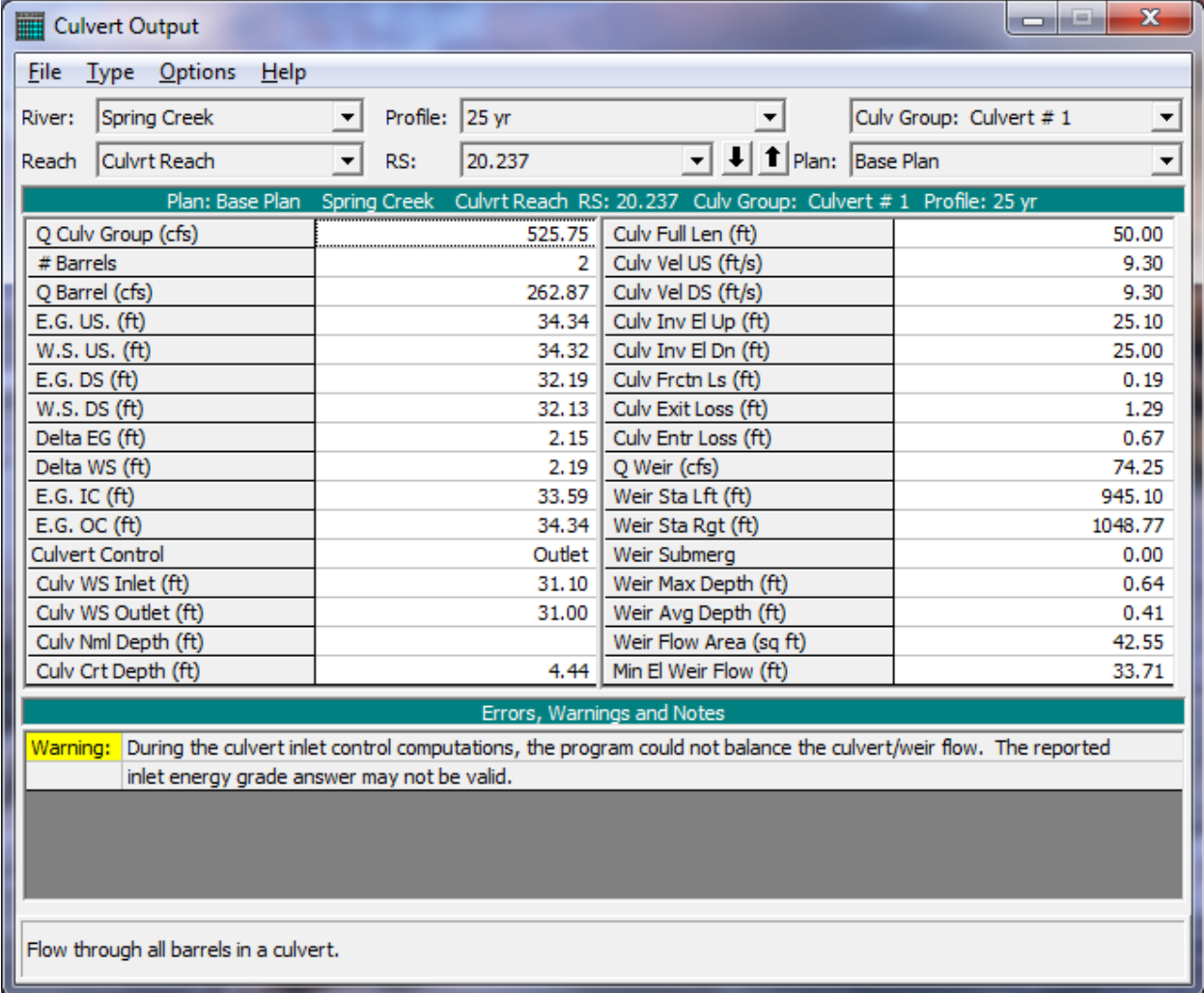

Figure 3-15: Culvert Table For Flow=600 cfs

The following discussion is provided as an example procedure that can be utilized to balance the weir flow with the overbank flow. The modeler should compare the magnitude of the weir flow to the total flow rate to determine if the procedure is practical for the specific situation.

To adjust the LOB and ROB flow values, first the situation at river station 20.227 was analyzed. Since there was not any flow in the overbanks, the ineffective flow elevation was lowered from 33.3 to 32.0. This will allow for the flow coming over the weir to become active at this downstream cross section. The elevation of 32.0 feet was chosen because it is slightly lower than the calculated water surface (32.01 feet) at river station 20.227. (The user must be cautious not to lower this elevation to a point where the ineffective flow will impact the second flow profile. Each flow profile must be analyzed separately.)

As a second step to balance the weir and overbank flows, at river station 20.238 the Manning's n values in the overbanks were raised from 0.1 to 0.4. Additionally, at river station 20.227, the Manning's n values for the overbanks were decreased from 0.10 to 0.06. Since the n value is inversely proportional to the flow rate, the increase in n value at river station 20.238 will cause a decrease in the flow rate in the overbank areas. Similarly, the decrease in



the n value at river station 20.227 will cause an increase in the flow rate in the overbank areas.

After these adjustments were made, the geometry file was saved as "Adjusted Ineffective + n Values." Then this geometry file and the steady flow data file were saved as a plan entitled "Sp. Cr. Culverts - Adj. Weir Flow." The user can activate this plan to review the remaining discussion of the output.

After the adjusted plan was executed, the weir flow at river station 20.237 was determined to be 74.20 cfs, as shown in the Culvert Table of Figure 3.16. This weir flow occurred from X-coordinates of 945.08 to 1048.78, a distance of 103.65 feet. As calculated previously, the approximate portion of this weir flow that occurred from 945.11 to 972 is:

$$(972.00 - 945.08)/(103.7) \cdot (74.32) = 19.29 \text{ cfs}$$

Similarly, the portion of the weir flow from 1027 to 1048.78 was approximately 15.6 cfs. These flow values were then compared to the flow values in the LOB and ROB at river stations 20.227 and 20.238.

At river station 20.227, the flow in the LOB was 6.93 and the flow in the ROB was 5.60 cfs. These values are approximately equal to the portions of the weir flow values as determined above. Therefore, these flow rates were considered as being balanced with the weir flow. If the flows in the overbanks had been higher than the portions of the weir flow, then the Manning's n values in the overbanks at river station 20.227 would have been increased until a balance was achieved.

At river station 20.238, the flow in the left and right overbanks were 9.91 and 9.38 cfs, respectively. These flow rates were considered to be reasonably in balance with the portions of the weir flow. If the flow rates were not in balance, then the n values would have been adjusted further until a balance was achieved.

For both river stations 20.227 and 20.238, it should be noted that the flow rates do not exactly match the portions of the weir flow as calculated above. An exact match is not warranted because the weir flow portions were approximate and the weir flow that contributes to the left and right overbank is only a minor portion of the total flow rate. If observed high water marks were available, the modeler could make adjustments to the data to more accurately predict the actual water surface elevations.

Example 3 Single Culvert – Single Bridge

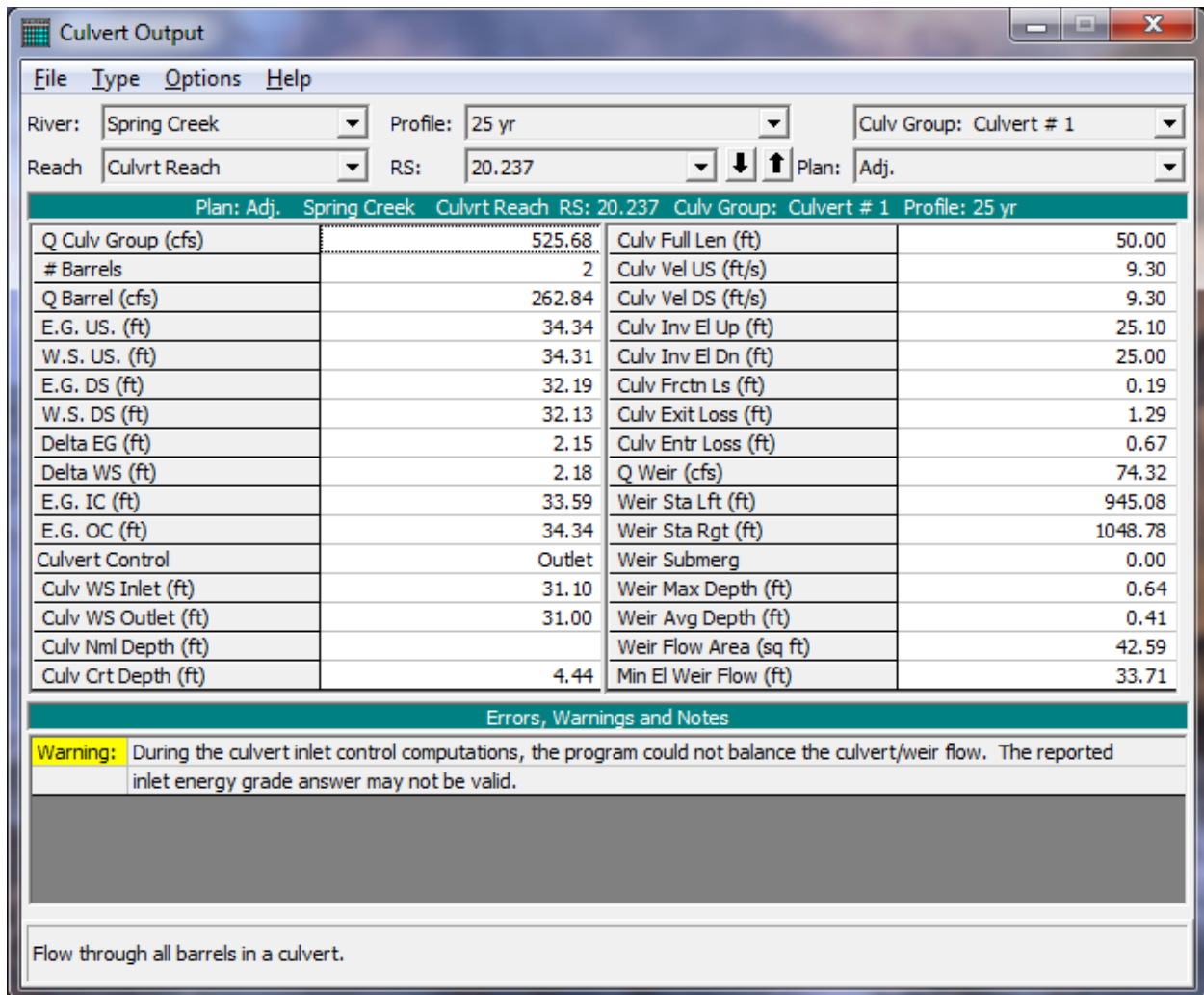

Figure 3-16: Culvert Table for Adjusted n Values and Ineffective Flow Areas With Flow = 600 cfs

For additional detailed analysis of the flow, the modeler should review the energy losses associated with the contraction and expansion of the flow in the channel and the entrance and exit losses for the culvert to evaluate the selected energy loss coefficients.

Finally, a three dimensional view of the water surface profiles is displayed in Figure 3.17. This was activated from the main program window by selecting View and then X-Y-Z Perspective Plots. The figure is available to aid the user to view the calculated water surface profiles. The water surface image represents the hydraulic grade line at the respective cross section locations.

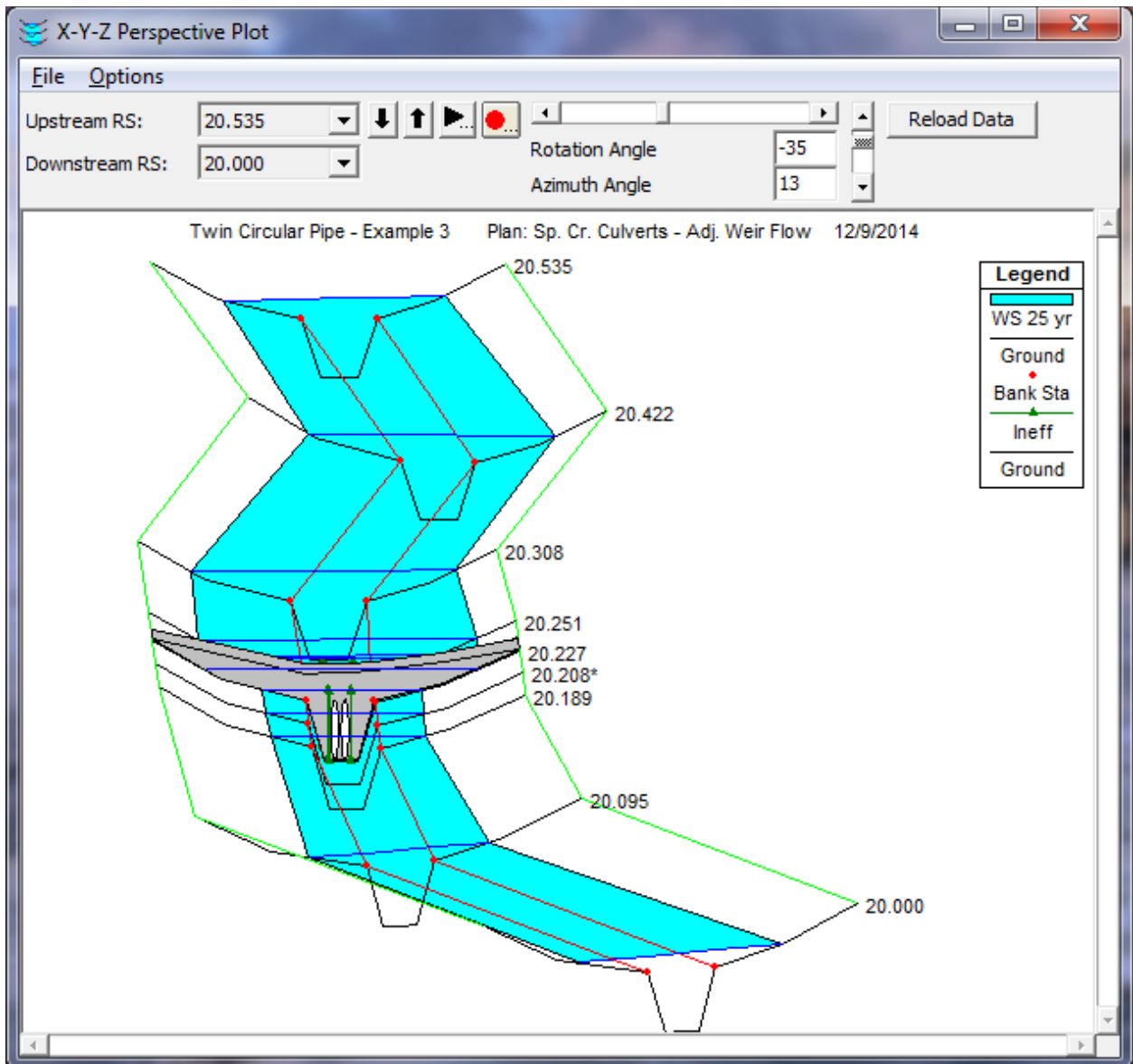

Figure 3-17: 3-D Perspective Plot of Spring Creek Flow Profiles

## Summary

For this example, a culvert was analyzed with three flows. The culvert was composed of two identical circular barrels. During the review of the output, it was determined that initially the flow in the left and right overbanks at the upstream and downstream cross sections from the culvert did not match the weir flow that was occurring. In order to balance the weir flow with the overbank flows, the Manning's  $n$  values and the ineffective flow areas were adjusted at the cross sections that bound the culvert.

The next example (Example 4) utilizes this data set and adds another culvert type to the geometric data. This creates a multiple culvert analysis, each with multiple identical barrels.



## CHAPTER 4

# Multiple Culverts

### Purpose

This example is designed to demonstrate the use of HEC-RAS to analyze the flow of water through multiple (non-identical) culverts. The program has the capability of analyzing flow through a single type of culvert, multiple identical types of culverts, and multiple non-identical types of culverts. A culvert type defines the characteristics of the culvert, which includes the shape, slope, roughness, chart, and scale number. For a given culvert type, the program can analyze up to 25 identical barrels. This example analyzed two culvert types, each with two identical barrels.

The entering of data and the analysis of these culverts was identical to the procedures used for the single culvert type as performed for Example 3. Additionally, the data used for Example 3 was modified for this example to include a second culvert type. Therefore, Example 4 is presented as a continuation of Example 3 and the modeler should review the data and the procedures as performed in Example 3 before reviewing Example 4.

The user is referred to Example 3 for the basic procedures of culvert analyses and to Chapter 6 of the Hydraulic Reference Manual for a detailed discussion on modeling culverts. To review the procedures performed for this example, from the main HEC-RAS window, select **File** and then **Open Project**. Go to the directory in which you have installed the HEC-RAS example data sets. From the "Applications Guide\Chapter 4 – Multiple Culverts" subdirectory, select the project labeled "Multiple Culverts - Example 4." This will open the project and activate the following files:

Plan:	"Spring Creek Multiple Culverts"
Geometry:	"Multiple Culvert Geometry"
Flow:	"Multiple Culvert Flow Data"

### Geometric Data

To perform the analysis, the geometric data was entered first. The geometric data consists of the river system schematic, the cross section geometry, placement of the cross sections, and the culvert information. Each of these geometric data components are described in the following sections.

#### River System Schematic

From the main program window, select **Edit** and then **Geometric Data** and the river system schematic of Spring Creek will appear as shown in Figure 4.1. This river reach is defined by ten river stations, with river station 20.535

## Example 4 Multiple Culverts

as the upstream cross section and river station 20.000 as the downstream cross section. The schematic is identical to the river reach as developed during Example 3.

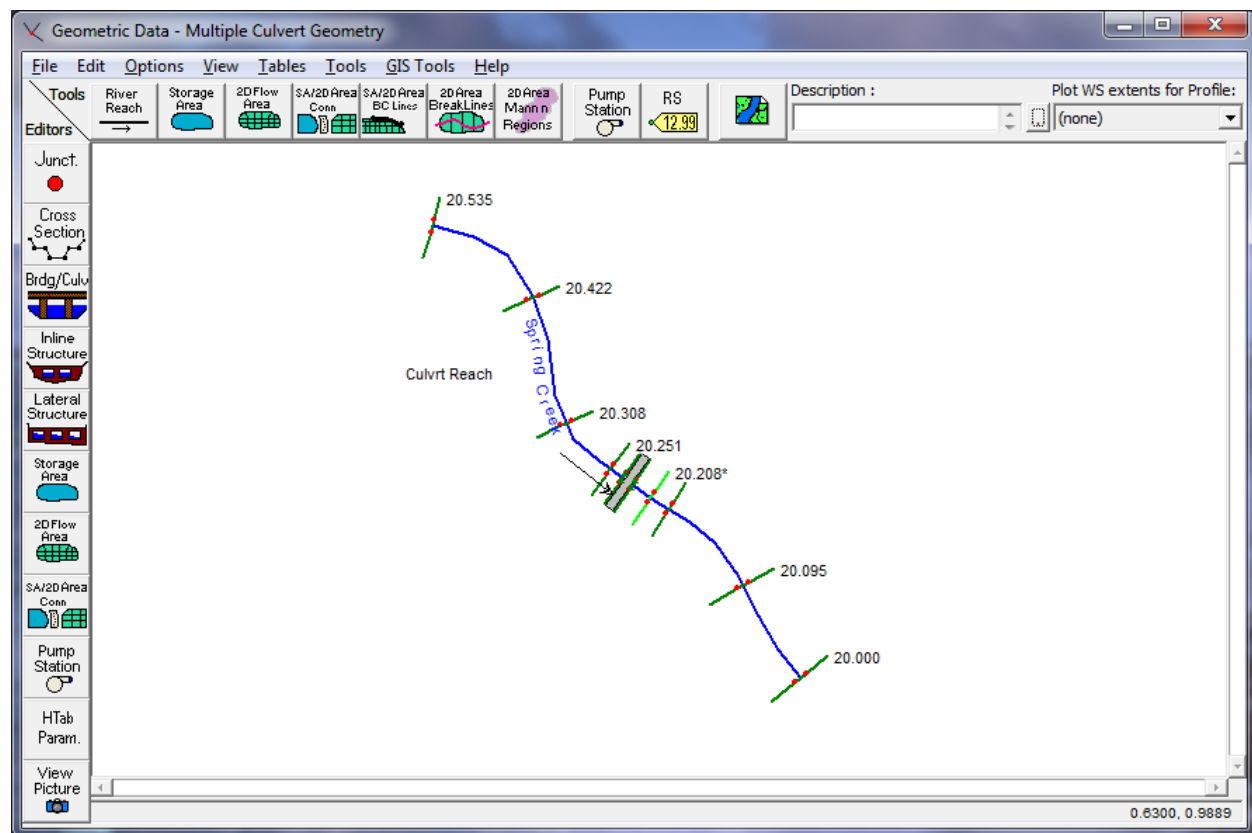

Figure 4-1: River System Schematic For Spring Creek

### Cross Section Geometry

The geometry of the cross sections for this example are identical to the geometry of the cross sections for Example 3. The modeler should review Example 3 for the stationing, elevations, reach lengths, Manning's  $n$  values, main channel bank stations, and contraction and expansion coefficients determined for each cross section. (Note: The Manning's  $n$  values for the LOB and ROB at river stations 20.238 and 20.227 were reset to the original value of 0.1.) Finally, the ineffective flow areas for the cross sections in the vicinity of the culvert were adjusted after the additional culvert information was added.

### Expansion and Contraction Reach Lengths

The placement of cross sections in reference to the culvert, define the expansion and contraction reach lengths. These reach lengths are crucial for the accurate prediction of the energy losses through the culvert. The determination of the reach lengths was discussed in detail during Example 3. During the analysis, it was observed that an additional cross section was required to be added to account for the expansion of the flow. This additional cross section was added as cross section number 20.208\*, with the \* indicating that the cross section was interpolated using the methods available

by the program. After the analysis for this example, the expansion and contraction reach lengths were again evaluated and will be discussed near the end of this example.

### **Culvert Data**

The culvert data consists of entering the deck/roadway data and the culvert geometric data. Each of these areas will be discussed as follows.

**Deck/Roadway Data.** The deck and roadway data editor is activated from the main program window by selecting **Edit, Geometric Data**, the **Bridge/Culvert** icon, and then the **Deck/Roadway** icon. This will display the **Deck/Roadway Data Editor** as shown in Figure 3.6 of Example 3. The values for this current example were exactly the same as those entered for Example 3.

**Culvert Geometric Data.** To enter the culvert geometric data, from the **Bridge/Culvert Data Editor** select the **Culvert** icon. This will activate the **Culvert Data Editor** and display the data for culvert #1 as shown in Figure 4.2. Culvert #1 is defined exactly as described for Example 3: a circular culvert of diameter 6 feet with two identical barrels and the other parameters as shown in Figure 4.2. In the upper right corner of the editor, the **Rename** button was selected and the new name "Circular" was entered. This will help the modeler during the review of the output for this example.

The output analysis of Example 3 showed that during the flow of 600 cfs, the flow overtopped the roadway and created weir flow. For this current example, we will consider the possibility that the flow must not overtop the roadway and that the modeler desires to install additional culverts to alleviate this problem. Alternatively, to reduce the upstream water surface depth, the modeler has extensive options available such as increasing the diameter of the existing culverts or adding other identical barrels to the culvert. For this example, however, the option of installing additional culverts was pursued.

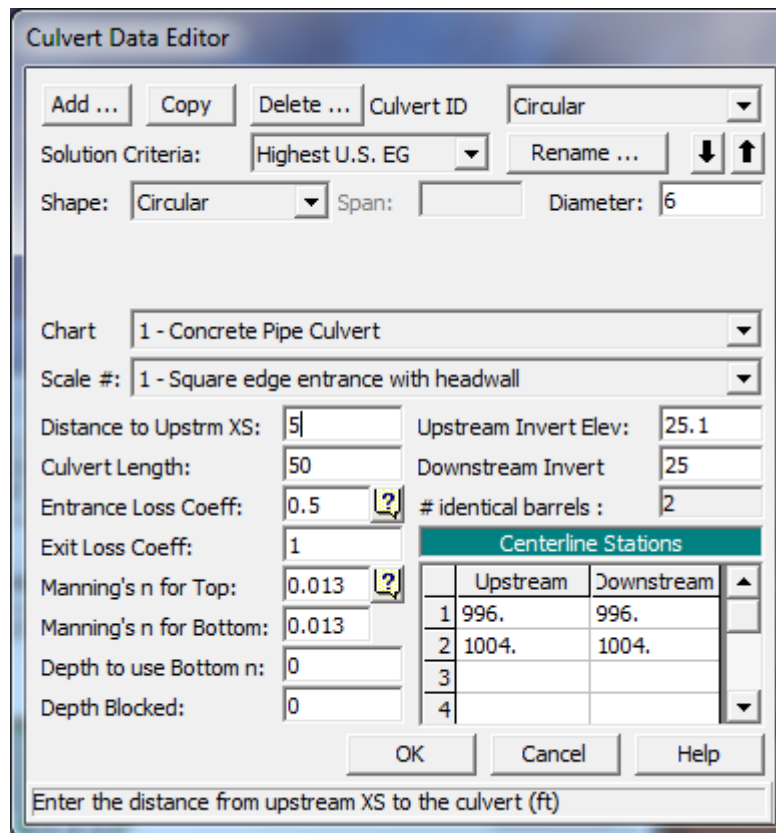

Figure 4-2: Circular Culvert Data Editor

From the Culvert Data Editor (as shown in Figure 4.2), the Add button in the upper left corner was selected. This cleared the entry fields and created a new input window as shown in Figure 4.3. The identification name "Culvert #2" appeared in the Culvert ID field in the upper right corner of the editor. The Rename button, located immediately below the Culvert ID, was selected and a new name "Box" was entered. The additional fields of the Culvert Data Editor will be described as follows.

*Solution Criteria* - The user has the option to select to use the result for inlet control or outlet control as the final answer for the upstream energy grade line value. The default method is to use the highest of the two values, as was selected for this example.

*Shape* - The culvert shape is chosen from the eight available shapes: circular, box, elliptical, arch, pipe arch, semi-circle, low or high arch. For this second culvert, the culvert shape was selected as box. To select the shape, press the down arrow on the side of the shape field and highlight the desired shape.

*Diameter, Rise, or Rise and Span* - Depending on the shape of the culvert, the modeler must enter the inside dimensions of the culvert shape. For a box shape, the rise (vertical distance) and span (horizontal distance) must be entered. A value of 5 feet for the span and 3 feet for the rise were entered. (Note: For box culverts with chamfered corners, refer to the discussion in Chapter 6 of the **Hydraulic Reference Manual**.)



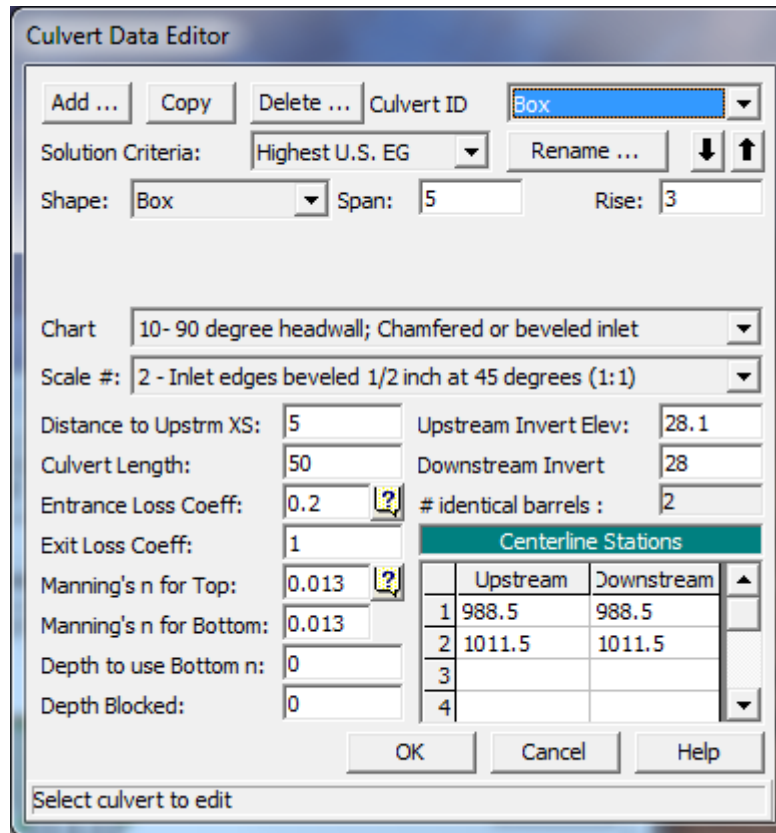

Figure 4-3: Box Culvert Data Editor

*Chart #* - Each culvert type and shape is defined by a Federal Highway Administration Chart Number. Depress the down arrow next to this field to select the appropriate chart number. Once a culvert shape has been selected, only the corresponding chart numbers available for that culvert shape will appear in the selections. Descriptions for the chart numbers appear in Chapter 6 on Table 6.5 of the **Hydraulic Reference Manual**. For this example, the culvert chart was selected as "10 - 90 degree headwall; Chamfered or beveled inlet edges."

*Scale* - This field is used to select the Federal Highway Administration scale that corresponds to the selected chart number and culvert shape. Only the scale numbers which are available for the selected chart number will appear for selection. Descriptions for the scale numbers appear in Chapter 6 on Table 6.5 of the **Hydraulic Reference Manual**. The scale for this example was "2 - Inlet edges beveled 1/2 in / ft at 45 degrees (1:1)."

*Distance to Upstream XS* - This is the distance from the inlet of the culvert to the upstream cross section (20.238). For this example, this was a distance of 5 feet. On the **Deck/Roadway Data Editor**, a measure of 10 feet was entered for the distance from the upstream side of the deck/roadway to the upstream cross section. Therefore, the culvert entrance is located midway between the upstream side of the roadway and cross section 20.238.

*Length* - This field is the measure of the culvert (in feet or meters) along the centerline of the barrel. The length of the culvert for this example is 50 feet.

The program will add this 50 feet to the 5 foot distance from cross section 20.238 (to the culvert entrance) and obtain 55 feet. The reach length from cross section 20.238 to 20.227 is 57 feet, which leaves 2 feet from the exit of the culvert to the downstream cross section.

*Entrance Loss Coefficient* - The value of the entrance loss coefficient will be multiplied by the velocity head at the inside upstream end of the culvert to obtain the energy loss as the flow enters the culvert. Typical values for the entrance loss coefficient can be obtained from Tables 6.3 and 6.4 in the **Hydraulic Reference Manual**. The entrance loss coefficient for the concrete box culvert was set at 0.2.

*Exit Loss Coefficient* - To determine the amount of energy lost by the water as it exits the culvert, the exit loss coefficient will be multiplied by the difference of the velocity heads from just inside the culvert at the downstream end to the cross section located immediately downstream from the culvert exit. In general, for a sudden expansion, the exit loss coefficient should be set equal to 1. However, this value may range from 0.3 to 1.0. For this example, the exit loss coefficient was set to be equal to 1.0.

*Manning's n for Top* - This field is used to enter the Manning's n value of the top and sides of the culvert lining and is used to determine the friction losses through the culvert barrel. Suggested n values for culvert linings are available in many textbooks and also may be obtained from Table 6.1 in the **Hydraulic Reference Manual**. Roughness coefficients should be adjusted according to individual judgment of the culvert condition. For this example, a Manning's n value of 0.013 was used for the concrete culverts.

*Manning's n Value for Bottom* - This field is used to enter the Manning's n value of the bottom of the culvert. For most culverts, this field will be the same as the Manning's n value for the top. However, if the culvert has a natural bottom, or something has been placed in the bottom for fish passage, the n value may vary.

*Depth to use Bottom n* - This field is used to enter a depth inside of the culvert that the bottom n value is applied to. If the bottom and top n value are the same, a value of zero should be entered.

*Depth Blocked* - This field is used to fill in a portion of the culvert. The user enters a depth, and everything below that depth is blocked out

*Upstream and Downstream Invert Elevation* - These two fields are used to enter the elevations of the inverts. For a particular culvert type, all of the identical barrels will have the same upstream invert elevation and downstream invert elevation. For this example, the upstream invert was set at an elevation of 28.1 feet and the downstream invert was 28.0 feet.

*Centerline Stations* - This table is used to enter the stationing (X-coordinates) of the centerlines of the culvert barrels. The upstream centerlines are based upon the X-coordinates of the upstream cross section (20.238) and the downstream centerlines are based upon the X-coordinates of the downstream cross section (20.227). This example employs two culvert barrels, with the centerlines of the barrels occurring at stations 988.5 and 1011.5 feet, as measured on both cross sections. For this example, the X-coordinate geometry of both cross section 20.238 and cross section 20.227 are referenced from the same left station starting point. Therefore, the upstream and downstream centerline stations are the same value and this will align the

culvert in the correct configuration as being parallel to the channel. The modeler must be cautious to ensure that the centerline stationing of the culvert ends align the culvert in the correct position.

*# identical barrels* - This field will automatically display the number of barrels entered by the user (determined by the number of centerline stations entered). Up to 25 identical barrels can be entered for each culvert type, and this box culvert consisted of 2 identical barrels.

This completed the necessary geometric data for the culverts. The **OK** button was selected and the final configuration of the culverts is as shown in Figure 4.4. (Note: The ineffective flow areas will be adjusted subsequently.) The modeler should now close the editor and save the data.

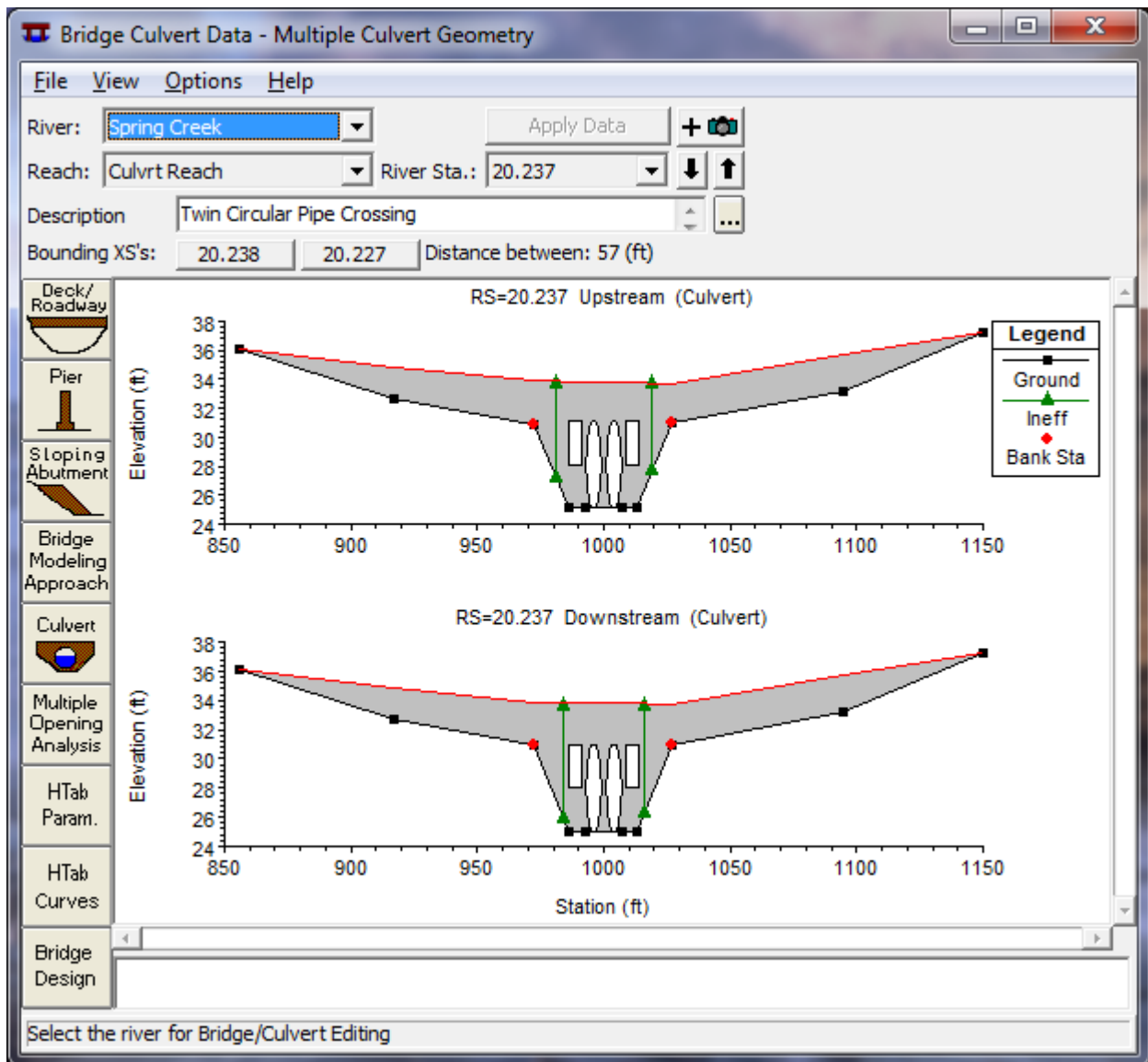

Figure 4-4: Box and Circular Culverts at River Station 20.237

## Ineffective Flow Areas

Since additional culverts were added at cross section 20.237, the ineffective flow areas at river stations 20.238 and 20.227 were adjusted for the new geometry. From the **Geometric Data Editor**, the **Cross Section** icon and river station 20.238 were selected. Select **Options** and then **Ineffective Flow Areas**. This activated the **Ineffective Flow Area Data Editor** as shown in Figure 4.5.

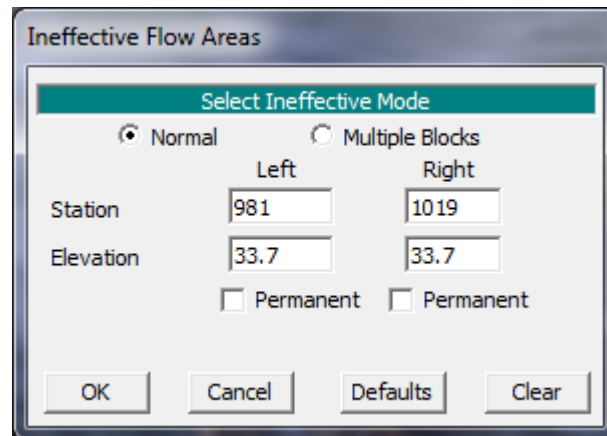

Figure 4-5: Ineffective Flow Area at River Station 20.238

The stationing of the ineffective flow areas at cross section 20.238 can be determined by using a 1:1 relationship to the distance of cross section 20.238 from the culvert entrance. For this example, cross section 20.238 is located 5 feet upstream from the culvert entrance. Therefore, the left ineffective flow station was set at 5 feet to the left of the left edge of the culvert openings. The left edge of the culvert opening is at station 986. This places the left ineffective flow station at station  $986 - 5 = 981$  feet. Similarly, the right ineffective flow station was set to be 5 feet to the right of the right edge of the culvert opening. This equates to station  $1014 + 5 = 1019$ . The elevation of the ineffective flow areas will remain as originally set for Example 3, at an elevation of 33.7 feet.

The ineffective flow areas at cross section 20.227 are determined in a similar manner as used for cross section 20.238; however, cross section 20.227 is placed at a distance of 2 feet downstream of the culvert exit. Therefore, the ineffective flow stationing at cross section 20.227 is 984 and 1016 for the left and right stations, respectively. The elevations for the ineffective flow areas at cross section 20.227 were set at 33.6, a value slightly lower than the lowest downstream high cord elevation.

This completed the required geometric data and the information was saved as the geometry file "Multiple Culvert Geometry."

## Steady Flow Data

To perform a steady flow analysis, the user must enter both the flow profile values and the boundary conditions. For this example, the profiles were computed for flows of 250, 400, and 600 cfs (as was used for Example 3). Additionally, the boundary conditions remained the same as used for Example 3. This included downstream boundary conditions of known water surface

elevations of 29.8, 31.2, and 31.9 feet for the three flows, respectively. If the stage is uncertain, the modeler should include a river reach long enough so that the downstream boundary conditions do not impact on the calculated water surface profiles within the reach of interest. This steady flow data file was saved as "Multiple Culvert Flow Data."

## Steady Flow Analysis

To perform the steady flow analysis, from the main program window Run and then Steady Flow Analysis were selected. This activated the window as shown in Figure 4.6. The geometry file "Multiple Culvert Geometry," the steady flow file "Multiple Culvert Flow Data," and a subcritical flow regime were selected. A Plan title of "Spring Creek Multiple Culverts" was entered, as well as a Short ID of "Mult Culvert" and then the **COMPUTE** button was selected to perform the steady flow analysis.

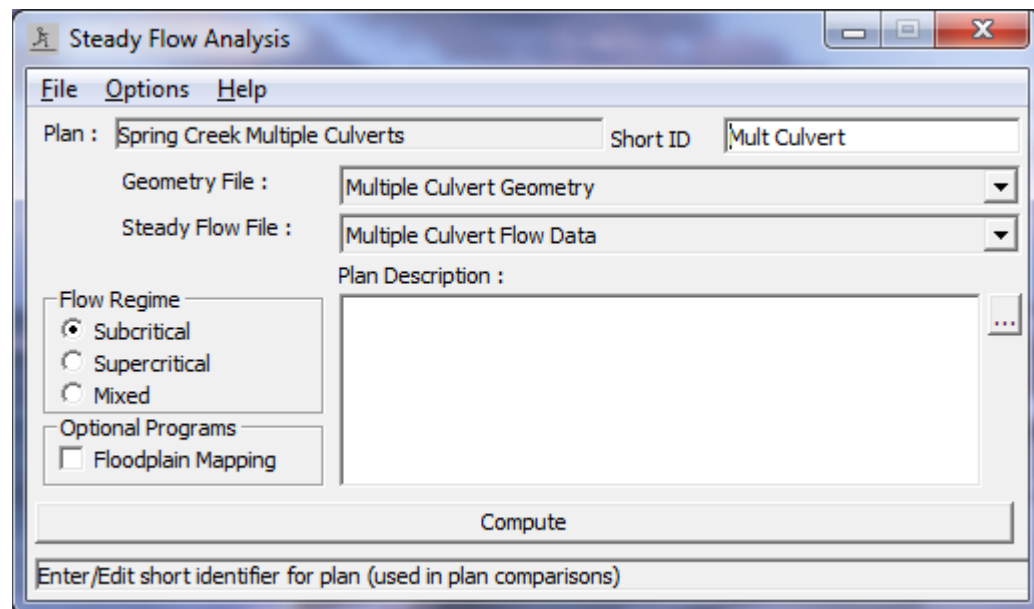

Figure 4-6: Steady Flow Analysis

## Output Analysis

To review the output, the modeler has various options and procedures. For this analysis, evaluations will be performed for: the expansion and contraction reach lengths, the channel contraction and expansion coefficients, and the water surface profiles.

### Expansion and Contraction Reach Lengths

Initially, during Example 3, the expansion and contraction reach lengths were determined using table values obtained from the USACE research document [HEC-1995]. These reach length values were then compared to the actual distances of the expansion reach length (from cross section 20.227 to cross section 20.189) and the contraction reach length (from cross section 20.251

to cross section 20.238). It was then determined that the contraction reach length was adequate for the analysis; however, the estimated expansion reach length was less than the distance from cross section 20.227 to cross section 20.189. Therefore, an additional cross section, 20.208\*, was interpolated and included as the location where the flow would fully expand. After the analysis for Example 3, the expansion and contraction reach lengths were computed using regression equations and compared to the predetermined values. For this current example, the regression equations will again be used to evaluate the expansion and contraction reach lengths.

**Expansion Reach Length.** Cross section 20.208\* was the interpolated section that was assumed to be at the location where the flow became fully expanded. To evaluate the location of this cross section, the relationship shown as Equation 4-1 was used. Equation 4-1 is applicable when the width of the floodplain and the discharge is less than those of the regression data. The equation is:

$$ER = \frac{L_e}{L_{obs}} = 0.421 + 0.485 \left( \frac{F_{20.227}}{F_{20.208^*}} \right) + 0.000018Q \tag{4-1}$$

- where:  $ER$  = expansion ratio
- $L_e$  = expansion reach length, ft
- $L_{obs}$  = average length of side obstruction, ft
- $F_{20.227}$  = main channel Froude number at the cross section immediately downstream of the culvert (cross section 20.227 for this example)
- $F_{20.208^*}$  = main channel Froude number at the cross section of fully expanded flow (cross section 20.208\* for this example)
- $Q$  = total discharge, ft<sup>3</sup>/s

(Note: The subscripts used in Equation 4-1 and all subsequent equations reflect the river station numbering for this example.) From the analysis, the Froude numbers at cross sections 20.227 and 20.208\* for the flow of 600 cfs are 0.18 and 0.14, respectively. Substituting these values into Equation 4-1 yields an expansion ratio of 1.06. The standard error for Equation 4-1 is 0.26, which yields a range of the ER from 0.80 to 1.32 to define the 68% confidence band. For this current example, the average length of obstruction is determined to be approximately equal to 60 feet. With this length of obstruction, the expansion reach length is:

$$L_e = (ER)(L_{obs}) = (1.06)(60) \approx 64 \text{ ft}$$

This is the median value of the range from 50 to 80 feet (using ER = 0.80 and 1.32, respectively). The actual distance from cross section 20.227 to cross section 20.208\* was set at 100 feet, which is only slightly greater than the

maximum value of the range as determined from Equation 4-1. Therefore, the existing reach length was not adjusted. Also, since the regression equation was based on studies conducted for low flow through bridges and since the flow for this example is less than the flow rates used to develop the equation, the expansion reach length was not adjusted from the existing value. Finally, the resulting expansion ratio should not exceed 4:1 nor should it be less than 0.5:1.

Contraction Reach Length. Cross section 20.251 is located where the flow lines are parallel to the main channel. To evaluate this location, Equation 4-2 will be utilized. This equation is used when the floodplain scale and dischargers are significantly different than those used in the regression analysis and is:

$$CR = 1.4 - 0.333 \left( \frac{F_{20.227}}{F_{20.208*}} \right) + 1.86 \left( \frac{Q_{ob}}{Q} \right)^2 - 0.19 \left( \frac{n_{ob}}{n_c} \right)^{0.5} \quad (4-2)$$

where:  $CR$  = contraction ratio

$L_c$  = contraction reach length

$Q_{ob}$  = discharge conveyed by the two overbanks at cross section 20.251, cfs

$Q$  = total discharge, cfs

$n_{ob}$  = Manning's n value of the overbanks at section 20.251

$n_c$  = Manning's n value for the main channel at cross section 20.251

From the analysis of the 600 cfs profile, the flow in the two overbanks at cross section 20.251 was 34.54 cfs and the Manning's n values for the overbanks and main channel at cross section 20.251 are 0.10 and 0.04, respectively. Substituting these values into Equation 4-2 yielded a contraction ratio of 0.68. The standard error for Equation 4-2 is 0.19, which yields a CR range from 0.49 to 0.87 to define the 68% confidence band. This range is less than the range obtained from Table B-2 of 0.8 - 1.5. Using the contraction ratio of 0.8 and an average obstruction length of 60 feet, the contraction reach length is:

$$L_c = (CR)(L_{obs}) = (0.8)(60) = 48 \text{ feet}$$

The existing contraction reach length (the distance from cross section 20.251 to cross section 20.238) is set at 70 feet, which is only slightly greater than the calculated value of 48 feet. Due to the uncertainty of the regression equation and since the data for this example were outside the range of the data used to develop the equation, the contraction reach length was not adjusted. Finally, the resulting contraction ratio should not exceed 2.5:1 nor should it be less than 0.3:1.

## Channel Expansion and Contraction Coefficients

The coefficients of expansion ( $C_e$ ) and contraction ( $C_c$ ) for flow in the cross sections are used to determine the energy losses associated with the changes in channel geometry. Initially, in the vicinity of the culvert, the coefficients were set at 0.5 and 0.3 for the expansion and contraction, respectively. Each of these values will be reviewed.

**Expansion Coefficient.** The expansion coefficient can be obtained from Equation 4-3:

$$C_e = -0.09 + 0.570 \left( \frac{D_{ob}}{D_c} \right) + 0.075 \left( \frac{F_{20.227}}{F_{20.208^*}} \right) \quad (4-3)$$

where:  $C_e$  = coefficient of expansion

$D_{ob}$  = hydraulic depth (flow area divided by the top width) for the overbank at cross section 20.208\*

$D_c$  = hydraulic depth for the main channel at cross section 20.208\*

From the analysis of the 600 cfs profile, the hydraulic depths for the overbanks and the main channel at river station 20.208\* are 0.58 and 5.66 feet, respectively. Substitution of the values into Equation 4-3 yields an expansion coefficient of 0.07. This is the median value and the range of  $\pm 0.2$  defines the 95% confidence band for Equation 4-3. For this example, a value of 0.5 was used. The value of the expansion coefficient is generally larger than the value used for the contraction coefficient so the value of 0.5 will remain as the selected value. The modeler can perform a sensitivity of this coefficient by changing this coefficient and performing subsequent analyses. For this example, the change in velocity head from cross section 20.227 to 20.208\* was only 0.06 feet. Since this value is small, a change in the expansion coefficient will only reflect a minor change in the resulting water surface elevation.

**Contraction Coefficient.** From the research document [HEC-1995], the contraction coefficient is obtained by first determining the relationship:

$$b/B = 28/145 \approx 0.20$$

where:  $b$  = culvert opening width, ft (m)

$B$  = total floodplain width, ft (m)

From Table B-3 in Appendix B of the Hydraulic Reference Manual, the recommended contraction coefficient range is 0.3 - 0.5. The value selected for this example was the minimum value of 0.3.

## Water Surface Profiles

From the main program window, select **View** and then **Water Surface Profiles**. This will result in the display as shown in Figure 4.7. In the figure,



the water surface profiles are shown for all three flows. As can be seen in the figure, the water surface for the first flow (250 cfs) was able to travel through the culverts without submerging the inlet or outlet. For the second and third flow profiles, it can be seen that the culvert entrance was submerged but that weir flow did not occur for either flow.

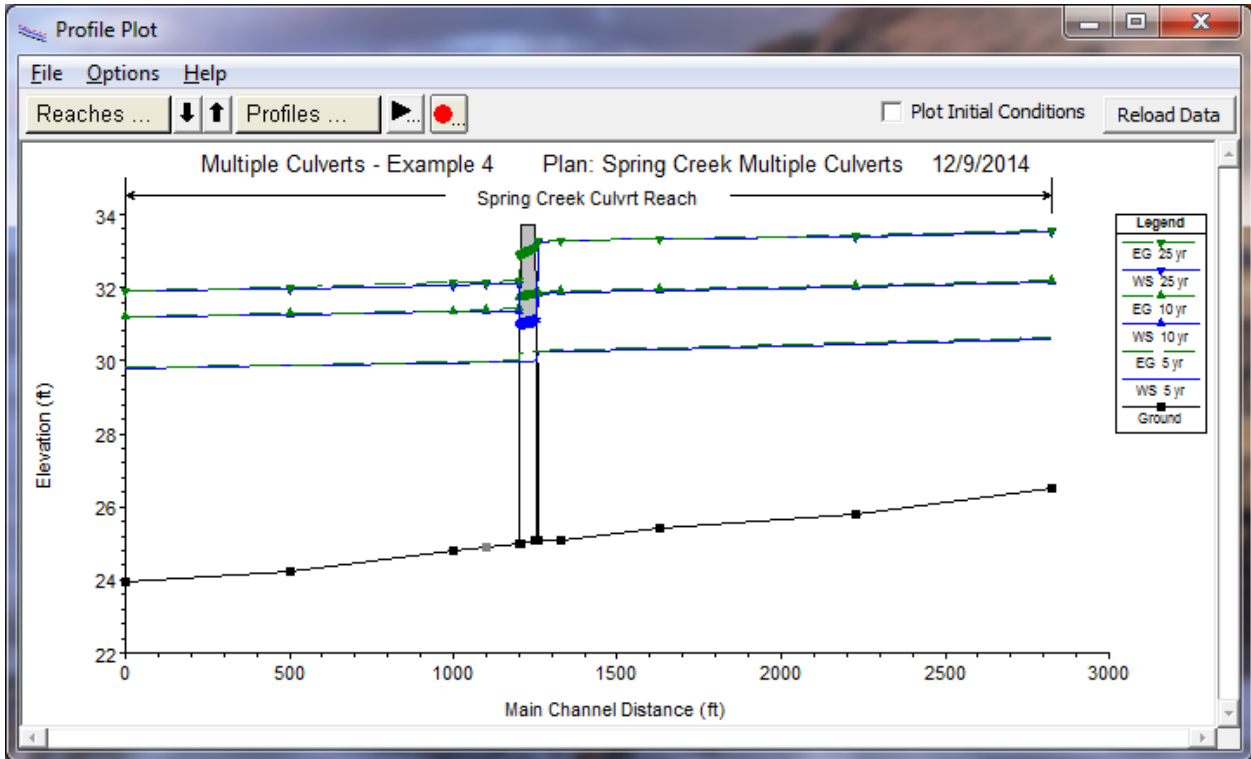

Figure 4-7: Water Surface Profiles For Spring Creek

To analyze this further, the modeler can view the profile output table to determine the depths of flow at the upstream side of the culverts. From the main program window, select **View, Profile Table, Std. Tables**, and then **Culvert Only**. This will display the table as shown in Figure 4.8.

Profile Output Table - Culvert Only

HEC-RAS Plan: Mult Culvert River: Spring Creek Reach: Culvrt Reach

Reach	River Sta	Profile	E.G. US. (ft)	W.S. US. (ft)	E.G. IC (ft)	E.G. OC (ft)	Min El Weir Flow (ft)	Q Culv Group (cfs)	Q Weir (cfs)	Delta WS (ft)	Culv Vel US (ft/s)
Culvrt Reach	20.237 Box	5 yr	30.28	30.25	29.99	30.29	33.71	74.73		0.29	3.94
Culvrt Reach	20.237 Circular	5 yr	30.28	30.25	28.65	30.27	33.71	175.27		0.29	3.56
Culvrt Reach	20.237 Box	10 yr	31.88	31.84	31.06	31.89	33.71	145.82		0.48	4.86
Culvrt Reach	20.237 Circular	10 yr	31.88	31.84	29.55	31.87	33.71	254.18		0.48	4.49
Culvrt Reach	20.237 Box	25 yr	33.29	33.22	32.19	33.29	33.71	216.11		1.12	7.20
Culvrt Reach	20.237 Circular	25 yr	33.29	33.22	30.95	33.29	33.71	383.89		1.12	6.79

Upstream energy grade elevation at bridge or culvert (specific to that opening, not necessarily the weighted average).

Figure 4-8: Culvert Only Profile Table

In Figure 4.8, the first two rows are for the flow through the box and circular culverts for the flow of 250 cfs. Then the second set of rows are for the flow of 400 cfs, and finally the last two rows are for the flow of 600 cfs. For both the box and the circular culverts, the upstream inside top elevation was set at 31.1 feet. By comparing this value to the upstream water surface elevation (W. S. US.), it is determined that both of the culverts were submerged at the entrance for the second and third flow profiles because the upstream water surface elevations were 31.83 and 33.22 feet, respectively.

Additional analysis of the table reveals that outlet control was the type of flow occurring through the culvert for all 3 flow profiles, because the outlet energy grade line was greater than the inlet control energy grade line. The flow through each culvert, for each flow profile, is shown in the column with the heading "Culv Q." For example, for the first flow profile (250 cfs), there was 74.73 cfs flowing through the box culverts (37.36 cfs through each barrel) and 175.27 cfs flowing through the circular culverts (87.64 cfs through each barrel). This totals  $74.73 + 175.27 = 250$  cfs and accounts for the total flow rate for the first flow profile. Finally, there are no values in the weir flow column of the table, which signifies that weir flow did not occur for these flow rates. This was an initial goal to develop a culvert system that produced no weir flow. The modeler can now determine the available freeboard on the upstream side of the roadway embankment and adjust the sizes and shapes of the culvert as deemed necessary.

For a more detailed analysis of each culvert, select **View, Cross Section Table, Type**, and then **Culvert**. Toggle to profile 3 (600 cfs) and select the "Box" as the **Culvert ID**. This will display the table as shown in Figure 4.9. This table displays additional information for the selected culvert and flow profile such as the length of the culvert flowing full and the energy losses. The modeler can compare these losses with values obtained for other entrance and exit loss coefficients. Finally, as displayed on the previous table, it can be seen that there is no weir flow occurring at this river station. The modeler can then toggle to the circular culvert at this river station by selecting the **Culvert ID field**. If additional culverts were located at other river stations, the data for these culverts can be viewed by selecting the appropriate river station.

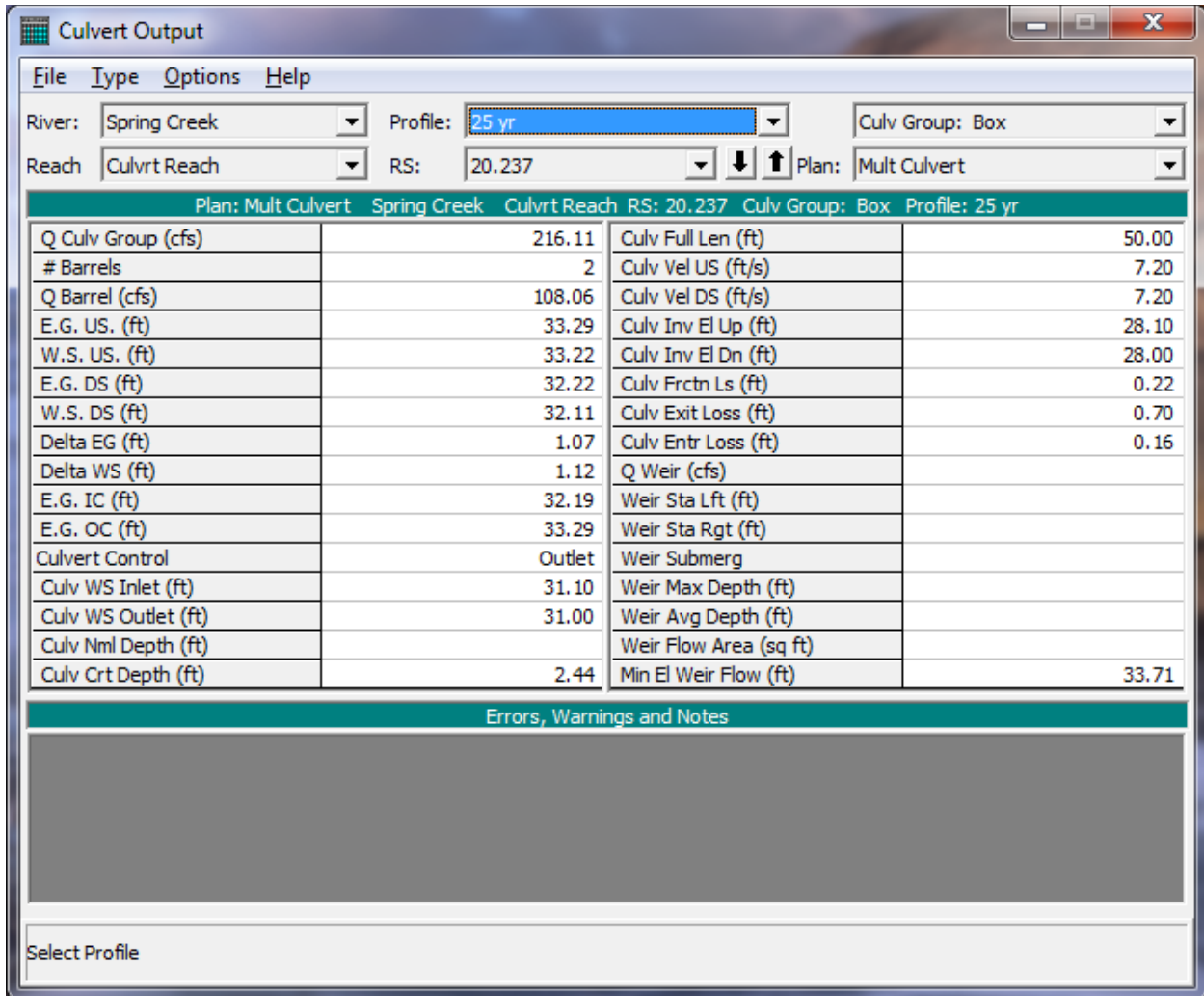

Figure 4-9: Culvert Type Cross Section Table

Finally, the location of the ineffective flow areas will be reviewed. From the main program window, select **View** and then **Cross Sections**. Toggle to river station 20.238 and this will display the cross section as shown in Figure 4.10. In the figure, it can be seen that the water surface elevations did not exceed the elevations set for the ineffective flow areas. Additionally, toggle to river station 20.227 and it can be seen that the water surface elevation is lower than the elevations set for the ineffective flow areas at this cross section. Since weir flow did not occur, the ineffective flow areas set for cross sections 20.238 and 20.227 should reasonably reflect the actual flow conditions.

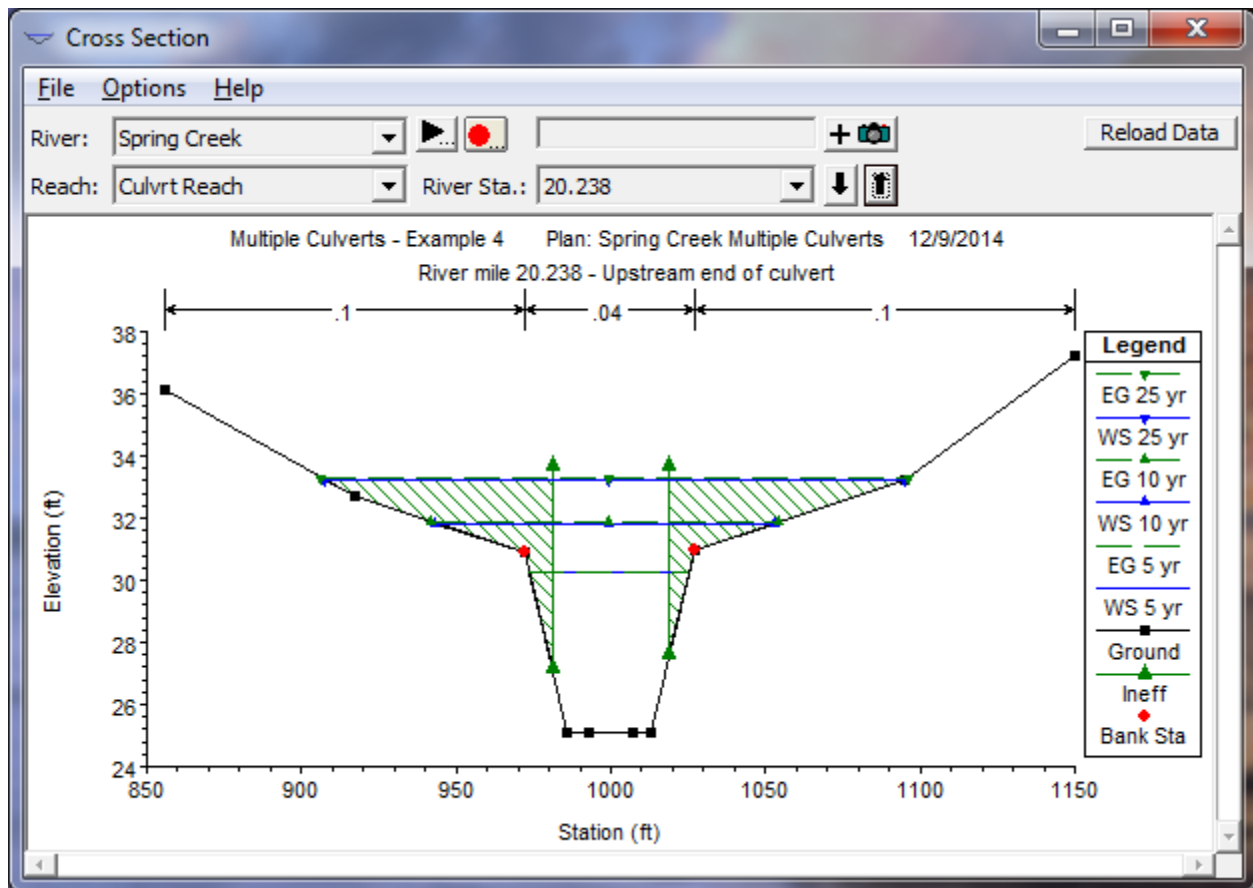

Figure 4-10: Cross Section 20.238 of Spring Creek

## Summary

This example demonstrated the use of HEC-RAS to analyze a river reach that contained a multiple culvert opening. The multiple culverts consisted of two culvert types (circular and box), each with two identical barrels. After the flow analysis was completed, the expansion and contraction reach lengths were evaluated and the ineffective flow areas were reviewed. Finally, the various output features (flow profiles, cross section type tables, and profile tables) were displayed to show the features available for a review of the output.

## CHAPTER 5

# Multiple Openings

### Purpose

This example demonstrates the analysis of a multiple opening. An opening is comprised of a bridge, a group of culverts, or a conveyance area (open channel flow other than a bridge or culvert). The program can analyze up to seven openings occurring at the same river station, and any number of bridge and culvert openings can be used. However, the program is limited to a maximum of two conveyance-type openings.

Data entry for a conveyance-type opening and a bridge opening are similar to the procedures used for Example 1 and Example 2, respectively. Entering data for a culvert group is similar to the procedures used for Examples 3 and 4. Therefore, it is recommended that the modeler be familiar with Examples 1 through 4 before continuing with this example.

To activate the data files for this project, from the main HEC-RAS window, select **File** and then **Open Project**. Go to the directory in which you have installed the HEC-RAS example data sets. From the "Applications Guide\Chapter 5 – Multiple Openings" subdirectory, select the project labeled "Multiple Openings - Example 5." To begin this example, the final results from the pressure/weir flow bridge analysis of Example 2 were used as the base starting conditions. These data files are included with this example as:

Plan:	"Base Conditions"
Geometry:	"Beaver Cr. + Single Bridge"
Flow:	"Beaver Cr. - 3 Flows"

During the maximum flow event of 14000 cfs for Example 2, the flow overtopped the roadway. For this current example, additional openings of a culvert group and a relief bridge were provided so that the flow did not overtop the roadway. These additional openings were included with the existing bridge opening at the same river station.

To perform this current example, the geometry file "Beaver Cr. + Single Bridge" was activated. Then, the procedures as outlined in this example were performed. Finally, the geometry was then saved as "Culvert Group + Relief Bridge." This geometry file and the steady flow data file "Beaver Cr. - 3 Flows" were then saved as a new plan entitled "Modified Conditions." This final plan, with the multiple opening geometry, is included with the project.

### River System Geometric Data

To perform the analysis, the geometric data were entered first. This data consists of the river system schematic, the cross section geometry, and the

placement of the cross sections in relation to the bridge and culverts. Each of these geometric data components are described in the following sections.

### River System Schematic

From the main program window, select **Edit** and then **Geometric Data**. This will display the river system schematic as shown in Figure 5.1. The river reach is defined by 12 river stations with river mile 5.0 as the downstream cross section, as developed during Example 2. Additionally, there is a bridge at river station 5.40, which is exactly as described during Example 2.

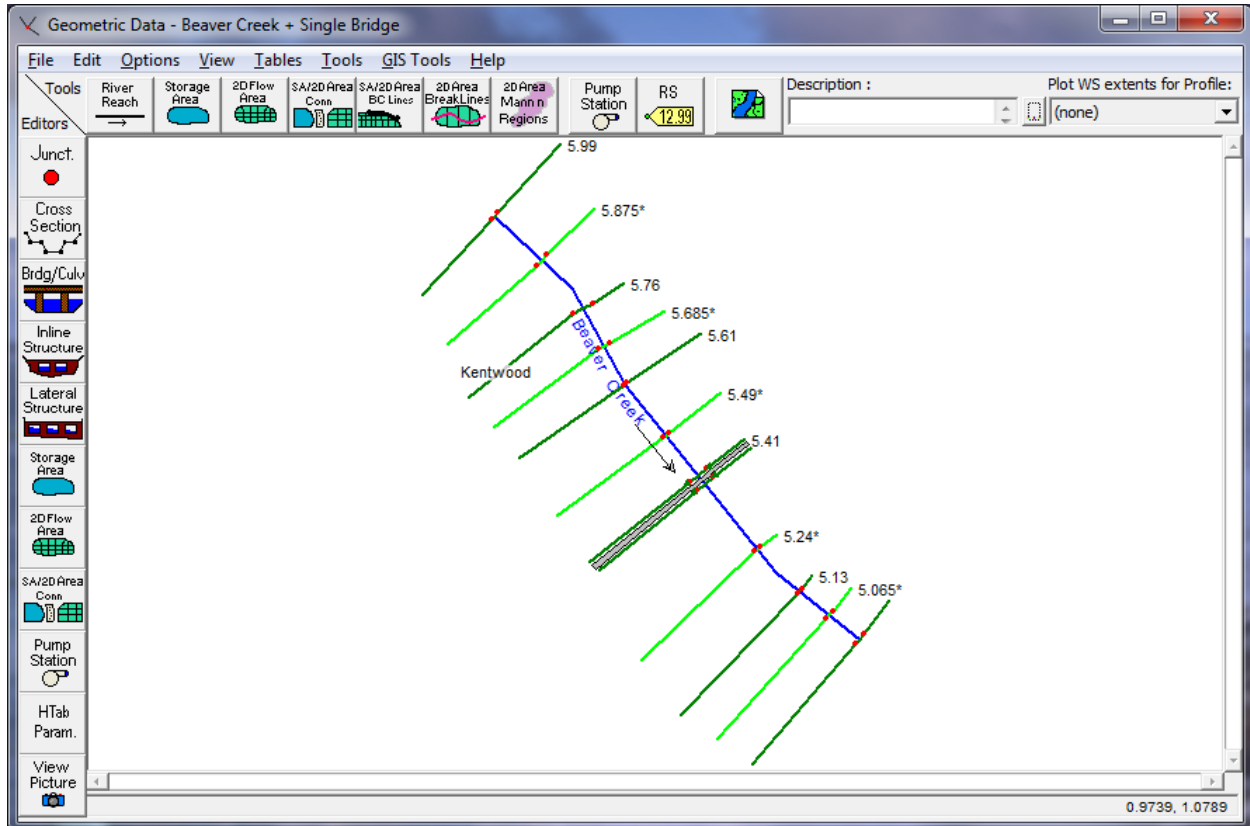

Figure 5-1: River System Schematic

### Cross Section Geometry

The cross section geometry consists of the cross section X-Y coordinates, reach lengths, Manning's n values, main channel bank stations, contraction and expansion coefficients, levees, etc. Each of these items are exactly as described for the cross sections in Example 2. (Note: The ineffective flow areas will be adjusted subsequently.)

### Placement of the Cross Sections

The placement of the cross sections in reference to a bridge or culvert opening is crucial for the accurate calculation of the energy losses through the structure. As described during Example 2, the expansion and contraction

reach lengths were adjusted to properly locate the cross sections in the vicinity of the bridge. For this current example, the expansion and contraction reach lengths will be adjusted to account for the inclusion of a culvert group and a flow relief bridge. This adjustment of the reach lengths was performed after the bridge and culvert data were entered and will be discussed in a subsequent section of this current example.

## Bridge Geometry

The bridge geometry is composed of the deck/roadway data, the pier and abutments, and the bridge modeling approach. Each of these items will be discussed in the following sections.

### Deck/Roadway Data

From the **Geometric Data Editor**, select the **Brdg/Culv** icon. This will activate the **Bridge/Culvert Data Editor** as shown in Figure 5.2. During Example 2, the reach of "Kentwood" was selected and a bridge was placed at river station of 5.40. Then the deck/roadway data were entered by selecting the **Deck/Roadway** icon on the left side of the editor. The deck and roadway data for the main bridge are identical to the data entered for Example 2.

For the current example, a flow relief bridge was added at river station 5.40. To add this bridge, first the bridge deck and roadway data were entered by selecting the **Deck/Roadway** icon. This activated the **Deck/Roadway Data Editor** as shown in Figure 5.3. The additional high and low cord information for the second bridge was then added to provide for an opening for the second bridge. This was accomplished by scrolling down to the end of the existing data and then entering the stations and elevations for the high and low cords of the second bridge. The data appears in Figure 5.3, showing the bridge opening from X-coordinates of 960 to 1240, with the low and high cords of 215.7 and 216.93 feet, respectively. (These values are the same as used for the first main bridge.) After the data were entered, the editor was closed. It should be noted that the distance, width, weir coefficient, and other parameters of the **Deck/Roadway Data Editor** will be the same for the second bridge as for the first bridge.

Example 5 Multiple Openings

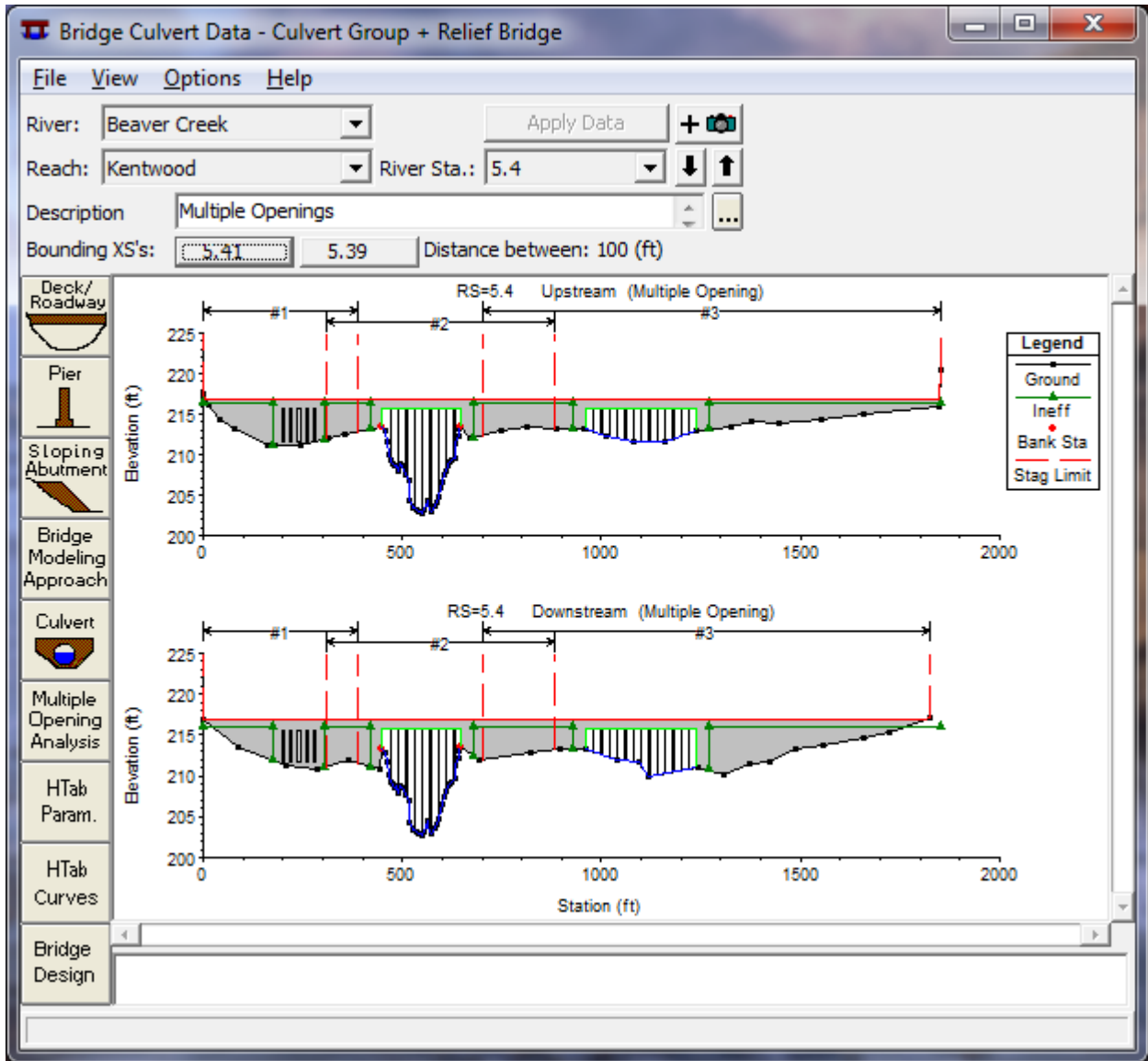

Figure 5-2: Bridge/Culvert Data Editor



Distance	Width	Weir Coef
30	40	2.6

Upstream				Downstream		
	Station	high chord	low chord	Station	high chord	low chord
1	0.	216.93	200.	0.	216.93	200.
2	450.	216.93	200.	450.	216.93	200.
3	450.	216.93	215.7	450.	216.93	215.7
4	647.	216.93	215.7	647.	216.93	215.7
5	647.	216.93	200.	647.	216.93	200.
6	960.	216.93	200.	960.	216.93	200.
7	960.	216.93	215.7	960.	216.93	215.7
8	1240.	216.93	215.7	1240.	216.93	215.7

U.S Embankment SS: 2      D.S Embankment SS: 2

Weir Data  
 Max Submergence: 0.95      Min Weir Flow El:

Weir Crest Shape  
 Broad Crested  
 Ogee

OK      Cancel

Enter distance between upstream cross section and deck/roadway. (ft)

Figure 5-3: Deck/Roadway Data Editor

## Piers and Abutments

The next step was to enter the pier data. This was accomplished by selecting the **Pier** icon on the left edge of the **Bridge/Culvert Data Editor** (the editor shown in Figure 5.2). During Example 2 for the first bridge, each of the nine piers was entered with a starting elevation of 200 feet and an ending elevation of 216 feet, and a width of 1.25 feet. The piers were located starting at a centerline station of 470 and were placed at a distance of 20 feet on center, yielding an ending centerline station of 630. To add the piers for the second bridge, for this current example, the **Pier** icon was selected and the **Add** button was chosen. This created a new pier (#10) and the centerline station was set at 980. The starting (200 feet) and ending (216 feet) elevations for this pier were the same as for the other piers. As before, the elevations were chosen to be below the ground level and inside the bridge decking. The program will automatically remove the pier area below the ground and inside the decking. Finally, the **Copy** button was selected to enter a total of 13 additional piers, 20 feet on centers, ending at a centerline station of 1220. (The bridge opening ended at an X-coordinate of 1240 feet.) This completed the addition of the new piers for the flow relief bridge.

Finally, any sloping abutments should now be entered for the analysis by selecting the **Sloping Abutment** icon the left side of the **Bridge Culvert Data Editor**. For this example, the bridge geometry did not include sloping abutments.

## Bridge Modeling Approach

From the **Bridge/Culvert Data Editor**, select the **Bridge Modeling Approach** icon. This will activate the **Bridge Modeling Approach Editor**. For a multiple opening analysis, if only one bridge modeling approach is developed, then the program will default to use that approach for all of the bridges. Alternatively, the user can develop an approach (coefficient set) for each of the bridges in the river station. For this current example, the **Add** button was selected at the top of the editor for the main bridge (as developed during Example 2) and this created a second bridge modeling approach, which is shown in Figure 5.4. The data entered for this second bridge modeling approach are shown in Figure 5.4.

This completed the input required for the bridge geometry and the **OK** button was selected at the bottom of the editor. Next, the culvert geometry was entered.

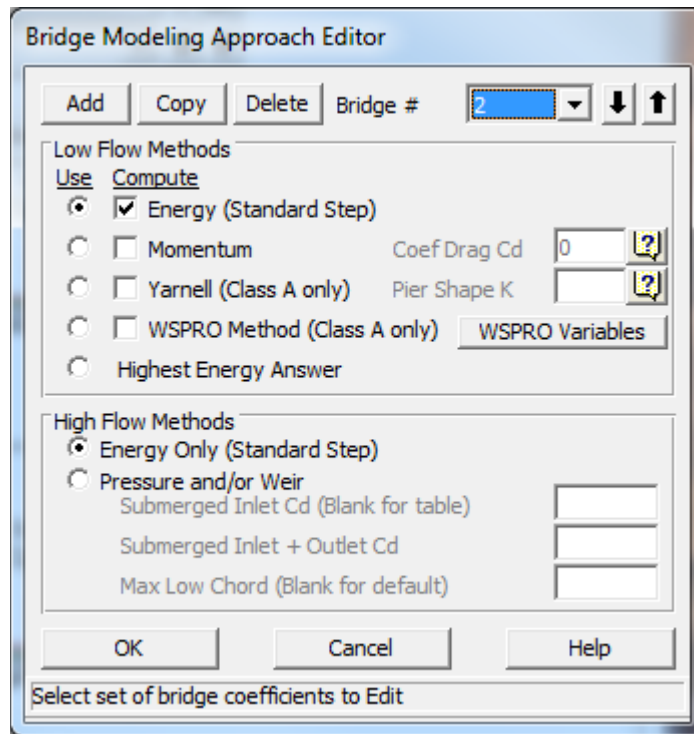

Figure 5-4: Relief Bridge Modeling Approach Editor

## Culvert Geometry

To enter the culvert geometry, the **Culvert** icon was selected from the **Bridge/Culvert Data Editor**. This activated the **Culvert Data Editor** as shown in Figure 5.5. The procedure for entering the culvert data is similar to the procedures as used during Examples 3 and 4. The following is a brief summary of the steps used to enter the culvert data for this current example.

The first culvert ID will automatically be set to "Culvert #1." This was changed to "Box #1" by selecting the **Rename** button. Then the *Solution Criteria* was selected as "Highest Upstream Energy" and the *Shape* "Box " was selected. A rise of 4 feet and a span of 6 feet were then entered. *Chart*

number 8 and *Scale* number 1 were selected to describe the FHWA standard culvert parameters. Additionally, the *Distance to Upstream XS* was entered as 20 feet, *Length* was measured to be 60 feet, the Manning's n - *Value* was set at 0.013, and the *Entrance and Exit Loss Coefficients* were set at 0.5 and 1.0, respectively. The upstream and downstream *Invert Elevations* and the upstream and downstream *Centerline Stations* were entered for each of the 5 identical barrels, as shown in Figure 5.5, and the *# identical barrels* displayed a value of 5.

It should be noted that if the multiple opening analysis had been configured as a bridge in between two culvert groups, then the two culvert groups should be entered as separate culvert types. This will enable the program to distinguish between the different opening locations. Upon entering the culvert information, the **OK** button was selected to exit the culvert editor.

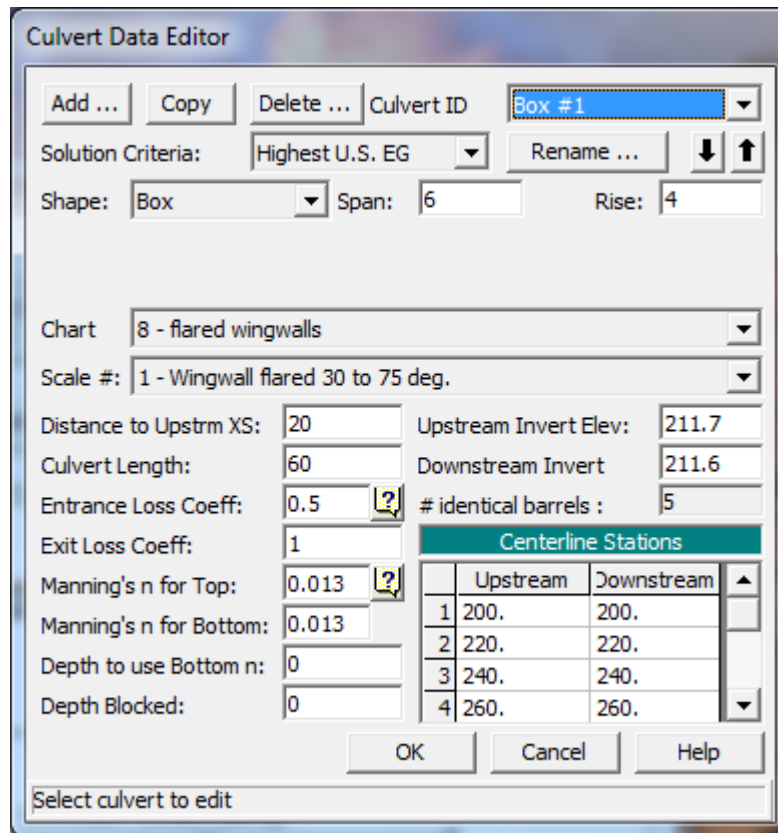

Figure 5-5: Box Culvert Data Editor

Finally, the user should highlight the piers and bridge openings from the **View** menu of the **Bridge/Culvert Data Editor**. Then, zoom in to view each of the bridge openings and the culvert barrels. This will enable the user to view any inconsistencies that may have developed during the data entry. This completed the data entry for the culverts. Next, the openings were defined for the multiple flow analysis.

## Multiple Openings

For the multiple opening analysis, the user must define the stagnation limits for the flow separation into each of the openings. After these limits were

defined, the ineffective flow areas and the Manning's n values were adjusted to account for the multiple openings. Each of these is discussed in the following sections.

### Stagnation Limits

As the flow approaches the river station that contains a multiple opening, the total flow will divide upstream from the multiple openings so that a portion will enter into each opening. Therefore, to perform the multiple opening analysis, the user must enter a left and right station for each opening which defines the X-coordinate range of the flow separation. The specific X-coordinate where the flow separates is called the stagnation point and this stagnation point is either determined by the program or set by the user. To perform the multiple opening analysis, from the **Bridge/Culvert Data Editor**, select the **Multiple Opening Analysis** icon. This will activate the **Multiple Opening Analysis Data Editor** as shown in Figure 5.6.

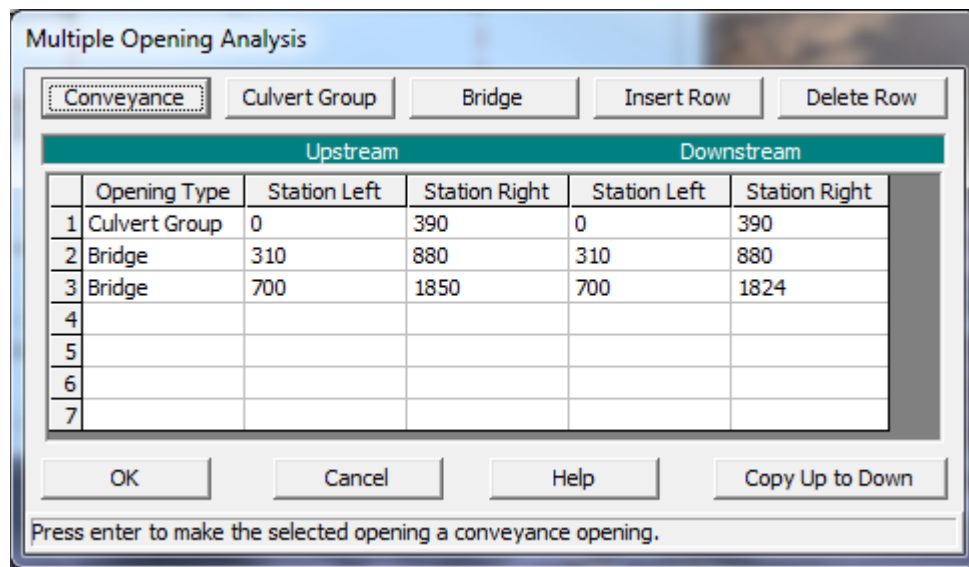

Figure 5-6: Multiple Opening Analysis Data Editor

First, the order of the openings are established from left to right as looking in the downstream direction. For this example, there were three openings: a culvert group, the main bridge opening, and then the relief bridge opening. To enter the data, the field under "Opening Type" and adjacent to number 1 was selected. Then, the **Culvert Group** icon was selected, because the first opening type was a culvert. This placed the description "Culvert Group" in the first row, under the heading "Opening Type."

Next, the upstream left and right stagnation limits were entered for the culvert group. These left and right stations will be used to determine where the flow separated between the culvert group and the bridge. For this example, the left and right stagnation limits were established as 0 and 390. Additionally, the downstream left and right stagnation limits were also entered as 0 and 390. The downstream stations define the X-coordinate limits where the flow from consecutive openings will rejoin.

Next, the field under "Opening Type" and adjacent to row number 2 was selected. Then, the **Bridge** icon was selected and the description "Bridge"

appeared as the second opening type. The left and right stagnation limits were entered for the bridge as 310 and 880 for both the upstream and downstream side. Finally, the third opening was selected as "Bridge" and the data entered as shown in Figure 5.6.

As can be seen in Figure 5.6, the right stagnation limit for the culvert group was set at 390 and the left stagnation limit for the main bridge was set at 310. This created an overlap area from 310 to 390. Since this overlap exists, the program will determine the actual location of the stagnation point (the flow separation point) between the culvert and the main bridge. By entering the data in this fashion, the stagnation point was then allowed to vary for each flow profile, within the limits from 310 to 390. Conversely, if the right stagnation limit of an opening coincides exactly with the left stagnation limit of the next opening, then the user has defined a specific stagnation point and this point will be fixed for all flow profiles. For a conveyance type opening, in the current version of the program, a fixed stagnation point must be used on both sides of the opening. For a further discussion on multiple opening analyses, refer to Chapter 6 of the **User's Manual** and Chapter 7 of the **Hydraulic Reference Manual**.

Once all of the data were entered into the **Multiple Opening Analysis Data Editor**, the **OK** button was selected. Then the locations of the stagnation limits can be viewed in the display of the **Bridge/Culvert Data Editor** as shown in Figure 5.2. The limits selected for the stagnation points for each opening are shown above the two cross section plots.

For guidance on selecting the stagnation limits, there are two main objectives. First, there is a physical limit. This implies that there might exist a physical attribute of the openings on the cross section that can be used to determine the stagnation limits. For example, the left stagnation limit for the culvert was set at the left edge of the cross section. Additionally, the right stagnation limit for the culvert cannot be placed in the main bridge opening. This would imply that the flow in front of the bridge would go over to the culvert and this is not a practical. Therefore, a physical right stagnation limit for the culvert would be the left side of the main bridge opening.

Secondly, for guidance on selecting the stagnation limits, there exists practical limits. For example, the flow in the cross section in between the culvert and the main bridge must separate at some point to travel into either opening. Since the bridge opening is larger than the culvert opening, more of the flow will probably go towards the bridge opening. Therefore, the right stagnation limit for the culvert should not be set all the way over to the left edge of the main bridge opening. The right limit for the culvert should be located at a practical limit before the bridge opening. This practical limit can be determined by analyzing the amount of conveyance in the area between the culvert and the bridge, and then developing a reasonable estimate of where the stagnation limit should be placed.

Finally, it is recommended that the user allow the stagnation points to migrate (where possible) rather than enter specific fixed stagnation points. This is important when evaluating several flows during the same run. Conversely, if the stagnation limits are allowed to migrate over a large distance, the program may experience difficulty in converging to a solution. When this occurs, the overlaps of the stagnation limits should be reduced.

## Ineffective Flow Areas

Before a steady flow analysis was performed, the ineffective flow areas were located. From the **Geometric Data Editor**, select the **Cross Section** icon and then toggle to river station 5.41. This is the river station immediately upstream of the multiple opening. For this example, blocked ineffective flow areas were set as shown in Figure 5.7.

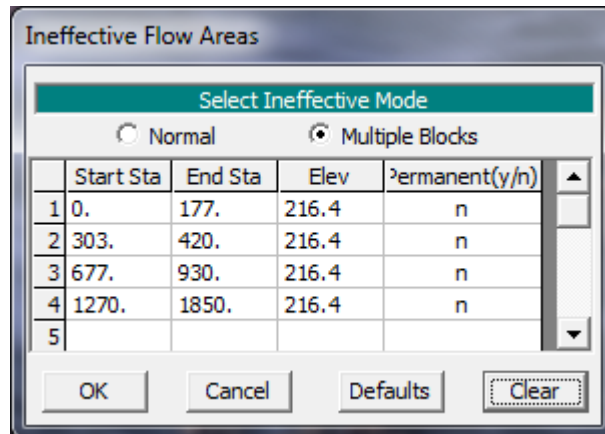

Figure 5-7: Blocked Ineffective Flow Areas for River Station 5.41

Four ineffective flow area blocks were established at this river station. These were located: to the left of the culvert group, in between the culvert group and the main bridge, in between the main bridge and the relief bridge, and finally to the right of the relief bridge. It should be noted that during a multiple opening analysis, the ineffective flow areas need to be described using the block method, not the normal method. The block method allows the user to enter ineffective flow areas in between the openings. Finally, ineffective flow blocks were defined at river station 5.39 (located downstream of the multiple opening). These ineffective blocked areas are shown as connected green lines on the **Bridge/Culvert Data Editor** (Figure 5.2).

The ineffective flow areas could have been entered along with the cross section geometry (X and Y - coordinates, etc.); however, for this example, the locations for the culvert group and relief bridge were established first. Then, the locations of the ineffective flow areas were more readily ascertained from the locations of the culverts and bridges.

## Manning's n Values

Due to the inclusion of the culverts and relief bridge, the Manning's n values in the overbank areas in the vicinity of the bridge were adjusted. It was assumed that during installation of these relief openings, portions of the densely forested overbank areas would be cleared for construction access and to allow the flow to enter the culverts and relief bridge. Therefore, the n values in the overbank areas at river stations 5.41, 5.39, and 5.33\* were adjusted to an appropriate value to represent the expected conditions.

## Cross Section Locations

As discussed previously, the placement of the cross sections in reference to a bridge or culvert opening is important for the accurate calculation of the energy losses through the structure. For this example, it will be considered that the majority of the flow will travel through the main bridge opening at the multiple opening river station. Therefore, the expansion and contraction reach lengths for the high flow event will be determined based on the main bridge opening. The following sections describe the procedures used to determine the expansion and contraction reach lengths as well as the expansion and contraction coefficients.

### Expansion Reach Length

To determine an initial estimate for the expansion reach length, the procedures as outlined in the USACE research document [HEC-1995] will be implemented. These procedures are discussed in Appendix B of the **Hydraulic Reference Manual**. First, the expansion ratio (ER) was estimated using the expansion ratio table (Table B.1). To determine the ER, the following parameters were necessary:

$$b = 200 \text{ ft}$$

$$B = 850 - 310 = 540 \text{ ft}$$

$$b / B = 200 / 540 = 0.36$$

$$S = 8 \text{ ft} / \text{mi}$$

$$n_{ob} / n_c = 1.75$$

$$L_{obs} = [(450 - 310) + (850 - 647)] = 170 \text{ ft}$$

where:	$b$	=	main bridge opening width, ft
	$B$	=	floodplain width contributing to flow through the main bridge, ft
	$S$	=	slope, ft/mi
	$n_{ob}$	=	Manning's n value of the overbanks
	$n_c$	=	Manning's n value of the overbanks
	$L_{obs}$	=	average obstruction reach length for the floodplain width contributing flow through the bridge, ft

The main bridge opening width,  $b$ , is obtained from the bridge geometric data and was determined to be 200 feet. The floodplain width for this scenario,  $B$ , will be the width of flow that contributes to the main bridge opening and is the distance from the left stagnation point to the right stagnation point of the main bridge opening. Since these stagnation points were entered as floating

values, an approximate location was assumed for this initial determination of the expansion reach length and the value was estimated as 540 feet.

Additionally, the average length of the side obstructions,  $L_{obs}$ , was estimated at 170 feet. This value was determined by only considering the floodplain width between the left and right stagnation points for the main bridge. Finally, the b/B ratio and the slope of the river reach are used to determine an initial estimate of the expansion ratio from the "Ranges of Expansion Ratios," Table B.1 in Appendix B of the **Hydraulic Reference Manual**. From the table, the ER was found to range from 1.3 - 2.0. An average value of 1.7 was used and this resulted with an expansion reach length,  $L_e$ , of:

$$L_e = (CR)(L_{obs}) = (1.7)(170) = 290 \text{ ft}$$

For this example, the expansion reach length is the main channel distance from cross section 5.39 to cross section 5.24\* which equals 778 ft. Therefore, an additional cross section was added at a distance of 290 feet downstream from cross section 5.39 based on the estimated expansion reach length as determined above.

To insert the additional cross section, field data should be used. If this is not available, then the user can utilize the interpolation routines. Then, the interpolated cross section should be compared with the existing geometry and topographic maps. For this example, the interpolation method was utilized to obtain a cross section at a distance of 290 feet downstream from river station 5.39. To perform this interpolation, it would be necessary to interpolate between river stations 5.39 and 5.24\*. However, the program will not allow for interpolation between an existing river station and a previously interpolated section. Therefore, the interpolation would be required from river station 5.39 to river station 5.13. Since this was a very long river reach, an alternative approach was employed by obtaining data from the USGS Atlas No. HA-601 (This atlas provided the data for Example 2.). From the atlas, the data for river station number 5.29 was entered into the existing geometry data file. Then, an interpolation was performed between river stations 5.39 and 5.29.

The interpolation procedure was performed by opening the **Geometric Data Editor**, then selecting the **Cross Section** icon, **Options**, then **Add a new Cross Section**. River station 5.29 was entered as the new location for the cross section and the data for river station 5.29 were entered, with the downstream reach lengths being from river station 5.29 to 5.13\*. Since river station 5.29 was added, the existing reach lengths for river stations 5.39 were adjusted to 320, 500, and 580 feet for the LOB, main channel, and ROB, respectively. Then, from the **Geometric Data Editor**, the following was selected: **Tools, XS Interpolation, Between 2 XS's**. The upper river station was set to be 5.39 and this caused the lower river station to be 5.29. A maximum distance of 100 feet was entered and the interpolation was performed. This yielded 4 new river stations between 5.39 and 5.29, each 100 feet apart. The interpolated river stations of 5.37\*, 5.35\*, and 5.31\* were deleted and the program adjusted the reach lengths accordingly. This produced the river station 5.33\*, located 300 feet downstream from river station 5.39. For further discussion on the interpolation procedures, refer to Chapter 6 of the **User's Manual** and Chapter 4 of the **Hydraulic Reference Manual**. The goal was to obtain a river station 290 feet downstream from



5.39, and this distance of 300 feet was determined to be appropriate for an initial location.

### Contraction Reach Length

To determine an initial estimate for the contraction reach length, a similar procedure as for the expansion reach length was used. From Table B.2 "Ranges of Contraction Ratios," it was determined that the contraction ratio (CR) ranged from 0.8 to 1.4. An average value of 1.1 was selected and this yielded a contraction reach length,  $L_c$ , of:

$$L_c = (CR)(L_{obs}) = (1.1)(170) = 190 \text{ ft}$$

For the current example, the contraction reach length is the distance from river station 5.49\* to river station 5.41, a main channel distance of 478 feet. Therefore, a new cross section, located a distance of 190 feet upstream from river station 5.41 was inserted. The data for this new cross section was obtained from the USGS atlas, namely river mile 5.44. This river station is located 170 feet upstream from river station 5.41 and was considered appropriate for an initial estimate of the contraction reach length. Finally, the reach length values for river station 5.61 were adjusted to account for the inclusion of the new cross section.

### Coefficients of Expansion and Contraction

The coefficients of expansion and contraction are used by the program to determine energy losses due to the change in cross sectional area of the flow. In the vicinity of the bridge and culvert openings, the expansion and contraction coefficients were chosen as 0.5 and 0.3, respectively. These values represent coefficients in a range between a typical bridge section and an abrupt transition. In the areas throughout the remaining portion of the river reach, the expansion and contraction coefficients were set at 0.3 and 0.1, respectively. All of these values are initial estimates and should be reviewed by the user to determine their impact on the resulting water surface elevations.

After the expansion and contraction reach lengths were modified and the expansion and contraction coefficients were determined, the adjusted geometry was saved as a file entitled "Culvert Group + Relief Bridge." Then, this geometry file and the steady flow data file were saved as a new plan entitled "Modified Conditions." By saving new files, the original data set obtained from Example 2 remained unchanged and this will allow for a comparison between the multiple opening data and the data that contained just the single bridge geometry. Finally, by activating the new adjusted geometry plan, the user can view the reach lengths by activating the **Geometric Data Editor**, and then selecting **Tables**, and **Reach Lengths**. This table is shown in Figure 5.8. Similarly, the coefficients can be viewed by selecting **Tables** and then **Coefficients**.

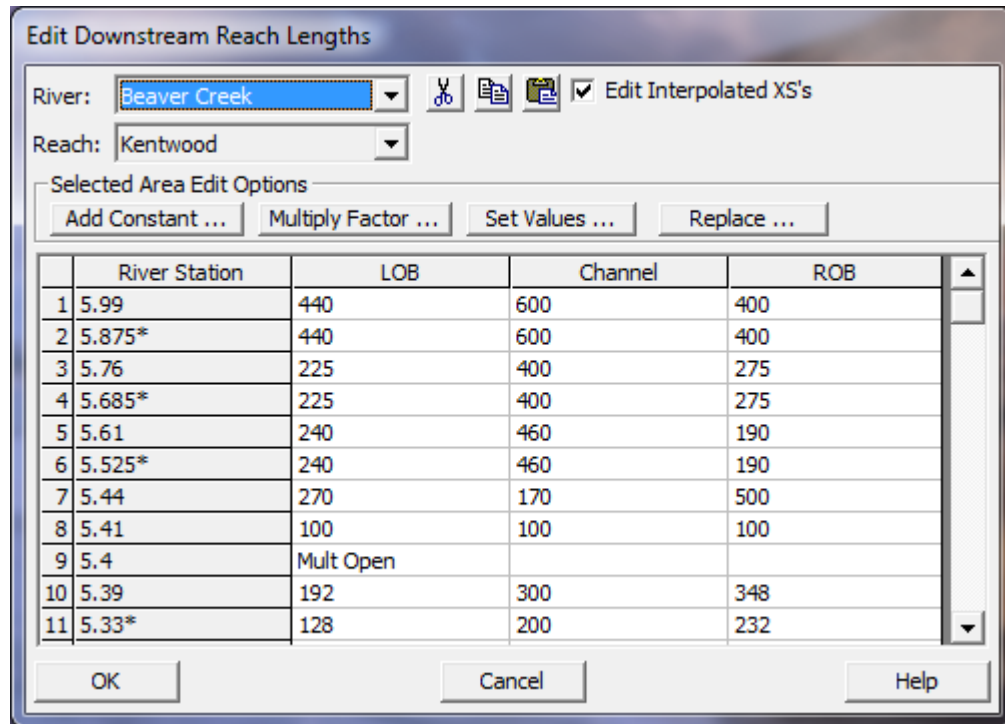

Figure 5-8: Reach Lengths Table for Modified Conditions Plan

## Steady Flow Analysis

After all of the geometric data were entered, the steady flow data file was created. From the main program window, select **Edit** and then **Steady Flow Data**. Three profiles were selected to be calculated with flows of 5000, 10000, and 14000 cfs. Then, the downstream boundary conditions were established as 209.5, 210.5, and 211.8. This steady flow data file is identical to the file produced during Example 2, and was used for this example. The user is referred to Example 2 for a further discussion on developing this steady flow data file.

Finally, the steady flow analysis was performed. From the main program window, **Run** and then **Steady Flow Analysis** was selected. A short identification for the plan was entered as "Mult Open." A subcritical flow regime was selected and the analysis was performed by selecting **COMPUTE**.

## Multiple Opening Output Analysis

This example demonstrates the use of the HEC-RAS program to analyze multiple openings that occur at the same river station. Therefore, this analysis will concentrate on the review of the multiple opening output. For a detailed discussion on the review of the individual culvert and bridge openings, refer to Example 2 for the bridge analysis and to Examples 3 and 4 for the culvert analysis. This analysis will review: the evaluation of the expansion and contraction reach lengths; the water surface profiles; and finally the multiple opening profile table.

## Cross Section Placement Evaluation

After the analysis was performed, the expansion and contraction reach lengths were evaluated using the regression equations outlined in the recent USACE document [HEC-1995] and which also appear in Appendix B of the **Hydraulic Reference Manual**. These reach lengths were evaluated for the main bridge opening during the largest flow event. However, the results from the regression equations did not provide reasonable results for the current example. One of the problems that arose was that the computed contraction reach lengths were longer than the expansion reach lengths. This is not reasonable because typically, the contraction reach length is shorter than the expansion reach length. This computed result may have arisen because the data for the example are not within the range of data used to develop the regression equations. The alternate equations, provided by the document, also produced inconsistent results. The regression equations were developed based on single bridge opening data sets. Therefore, they may not apply for a multiple opening bridge. The modeler should always use engineering judgment to the results obtained from these equations.

For this example, the reach lengths estimated at the beginning of the example will be used for the final analysis. These reach lengths were based on average expansion and contraction ratios for the main bridge opening. It was considered that these ratios provided a reasonable basis for estimating the expansion and contraction reach lengths. It should be noted that these reach lengths were significantly less than the reach lengths used in Example 2, with just the main bridge opening. With the multiple openings, the flow does not have to contract and expand as much as it would for a single opening.

## Water Surface Profiles

From the main program window, select **View** and then **Water Surface Profiles**. This will result in the display shown in Figure 5.9. The figure shows the three water surface profiles for the three flows of 5000, 10000, and 14000 cfs. By zooming in on the multiple opening location, it can be seen that the water surface for the high flow did not over top the bridge decking and this was the original goal for installing the relief bridge and culvert group.

Example 5 Multiple Openings

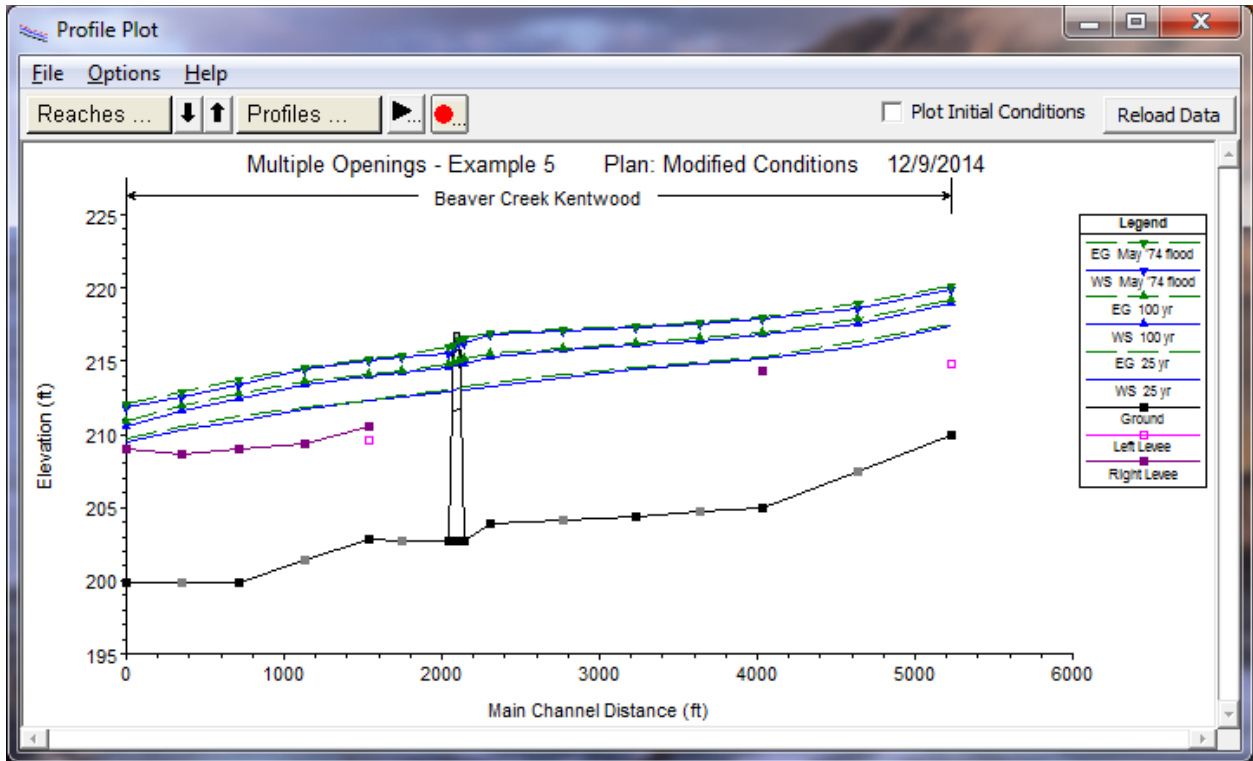

Figure 5-9: Water Surface Profiles for Modified Conditions Plan

### Multiple Opening Profile Table

To review the multiple opening profile table, from the main program window select **View, Profile Table, Std. Tables**, and then **Multiple Opening**. This will display the table shown in Figure 5.10. (Note: The table columns widths in Figure 5.10 were reduced to display the full table contents in the figure. Therefore, the column headings may not reflect the full descriptions.)

HEC-RAS Plan: Mult Open River: Beaver Creek Reach: Kentwood											
Reach	River Sta	Profile	Q Total	Flow Area	E.G. US.	W.S. US.	Top Wdth Act	Vel Total	Crit W.S.	Left Stagn	Right Stagn
			(cfs)	(sq ft)	(ft)	(ft)	(ft)	(ft/s)	(ft)	(ft)	(ft)
Kentwood	5.4 Culv Group #1	25 yr	105.41	245.26	213.22	213.22	126.00	0.43		73.69	310.00
Kentwood	5.4 Bridge #1	25 yr	4452.21	1198.20	213.25	213.03	211.34	3.72	208.43	310.00	700.00
Kentwood	5.4 Bridge #2	25 yr	442.38	333.80	213.25	213.23	340.00	1.33	212.36	700.00	1286.71
Kentwood	5.4 Culv Group #1	100 yr	345.18	491.45	215.18	215.17	126.00	0.70		25.97	310.00
Kentwood	5.4 Bridge #1	100 yr	7513.25	1644.08	215.17	214.81	257.00	4.57	210.07	310.00	700.00
Kentwood	5.4 Bridge #2	100 yr	2141.57	970.45	215.17	215.10	340.00	2.21	213.32	700.00	1678.39
Kentwood	5.4 Culv Group #1	May '74 flood	561.79	1294.57	216.54	216.53	301.88	0.43		8.12	310.00
Kentwood	5.4 Bridge #1	May '74 flood	9951.42	1987.13	216.58	216.14	257.00	5.01	210.93	310.00	880.00
Kentwood	5.4 Bridge #2	May '74 flood	3486.79	2797.57	216.57	216.55	967.36	1.25	213.73	880.00	1847.36

Total flow in cross section.

Figure 5-10: Multiple Opening Profile Table

As shown in Figure 5.10, the rows in the table are divided into three groups, one for each profile. The first three rows are for the first flow of 5000 cfs, the second group is for the flow of 10000 cfs, and the third group is for the flow of 14000 cfs. The second column in the table displays the river stations and the type of the multiple opening, in the order as they were entered in the **Multiple Opening Analysis Data Editor**. The third column displays the total flow rate through each of the opening types. For example, during the first flow profile (5000 cfs), there was 105.41 cfs flowing through the culvert group, 4452.21 cfs through the main bridge, and finally 442.38 cfs through the relief bridge. The sum of these values equals 5000 cfs.

The fifth column displays the calculated upstream energy gradeline elevation for each opening. During the multiple opening analysis, the program performs an iterative procedure to balance the upstream energy for all the openings. To do this, the program starts with an initial flow distribution through each opening and then calculates the upstream energy for each opening. If the energy values are within a specified tolerance (0.05 ft), then the solution is final. If the energy values for each opening are not within the specified tolerance, then a new flow distribution is estimated and the procedure is repeated, up to a maximum of 30 iterations. To determine the ranges for the flow distribution, the stagnation limits are used. For a further discussion on the multiple opening solution scheme, the user is referred to Chapter 6 of the **User's Manual** and Chapter 7 of the **Hydraulic Reference Manual**.

In reviewing the calculated energy gradeline values, it can be seen that for the three flow profiles, the energy gradeline elevations were balanced within the specified default tolerance of 0.05 feet. With these energy gradeline values, the program then calculates an upstream water surface elevation for each opening by subtracting the velocity head from the energy gradeline. These water surface elevations are displayed in the sixth column.

Finally, the last two columns of the multiple opening profile table display the calculated left and right stagnation points. These stagnation points are the flow distribution limits that were determined by the program in order to balance the upstream energy gradelines. For the first flow profile, it can be seen that the flow distribution was established from upstream X-coordinates of 73.69 to 310 for the culvert, from 310 to 700 for the main bridge, and from 700 to 1286.71 for the relief bridge.

For the culvert, the program used a left stagnation point of 73.69 feet. This value is the X-coordinate where the culvert water surface elevation of 213.22 intersected the left side of the cross section. The right stagnation point for the culvert was determined to be 310 feet. Therefore, in order to balance the upstream energy gradelines, the program determined that the flow rate through the culvert required an upstream conveyance that encompassed cross section station 73.69 to 310.

Similarly, for the first flow profile, the program determined that the flow through the main bridge opening would be from an upstream X-coordinate of 310 to 700 and the flow rate through the relief bridge would be from upstream X-coordinates of 700 to 1286.71. The value of 1286.71 is the X-coordinate where the relief bridge water surface elevation of 213.23 coincided with the right edge of the cross section.

Upon reviewing the left and right stagnation points for the third flow profile, it can be seen that the stagnation point between the culvert and the main bridge is a value of 310 feet as opposed to the previous value of 390. Therefore, in order to balance the upstream energy grade line elevations for the three openings, a greater portion of the total flow was required to travel through the main bridge opening during this higher flow event. Similarly, the left culvert stagnation point and the right relief bridge stagnation point have changed to reflect that the higher water surface elevations are approaching the limits of the cross section width.

Finally, the **Multiple Opening Profile Table** provides additional information such as the total cross sectional flow area and the top width of the effective flow. The descriptions for the column headings will appear in the dialog box at the bottom of the table when an entry in the specific column is selected.

As discussed previously, the energy gradeline elevations shown in the **Multiple Opening Profile Table** are the energy values for each of the openings, upstream of the openings. However, since the program is a one dimensional model, the program must determine only one energy grade line value to use at the upstream cross section. To determine this energy value, the program uses a flow weighting method to determine the average energy at the upstream cross section. Then, this average energy is used to calculate one water surface elevation for the entire upstream cross section. To review the energy gradeline and water surface elevations that were used as the final answer for the upstream cross section, from the main program window select **View, Cross Section Table, Type**, and then **Cross Section**. Toggle to river station 5.41 (the upstream cross section for this example) and select profile 3. This will display the table as shown in Figure 5.11.

For the third flow profile, the program calculated that the upstream energy gradeline elevations for the culvert, main bridge, and relief bridge were 216.54, 216.58, and 216.57 feet, respectively, as shown in the **Multiple Opening Profile Table**. However, as described above, the program can only use one energy grade line elevation at the upstream cross section. The flow weighted upstream energy gradeline elevation used for cross section 5.41 is shown in Figure 5.11 to be 216.58. Additionally, the program had calculated the upstream water surface elevations for each of the three openings as 216.54, 216.14, and 216.54, respectively, as shown in the **Multiple Opening Profile Table**. However, the program can only use one water surface elevation at the upstream cross section. To obtain this one water surface elevation, the program used the average energy value, subtracted the average velocity head for the entire cross section of 0.38, and determined that the upstream water surface elevation was 216.20, as shown in Figure 5.11. This water surface elevation is calculated from the average energy of the upstream section. The actual water surface elevations at the bridge are more likely reflected by the values as shown in the **Multiple Opening Profile Table**.

As a final component of the analysis, the flow distribution for the three openings was compared to the flow in the LOB, main channel, and ROB at the river stations upstream and downstream of the openings. From the **Multiple Opening Profile Table** (Figure 5.10), the flow for the third profile through the culvert, main bridge, and relief bridge were 561.79, 9951.42, and 3486.79 cfs, respectively. Since the culvert group is located in the LOB, the

main bridge is located over the main channel, and the relief bridge is located in the ROB, these flow values should approximate the flows in the LOB, main channel, and ROB at river stations 5.41 and 5.39. As shown in Figure 5.11, the flows for the third profile in the LOB, main channel, and ROB were 676.20, 10181.54, and 3142.25 cfs, respectively. Similarly, the flows at river station 5.39 were 705.59, 9931.67, and 3362.74 cfs. These flow distributions are similar and reflect the transition of the flow rates across the cross sections.

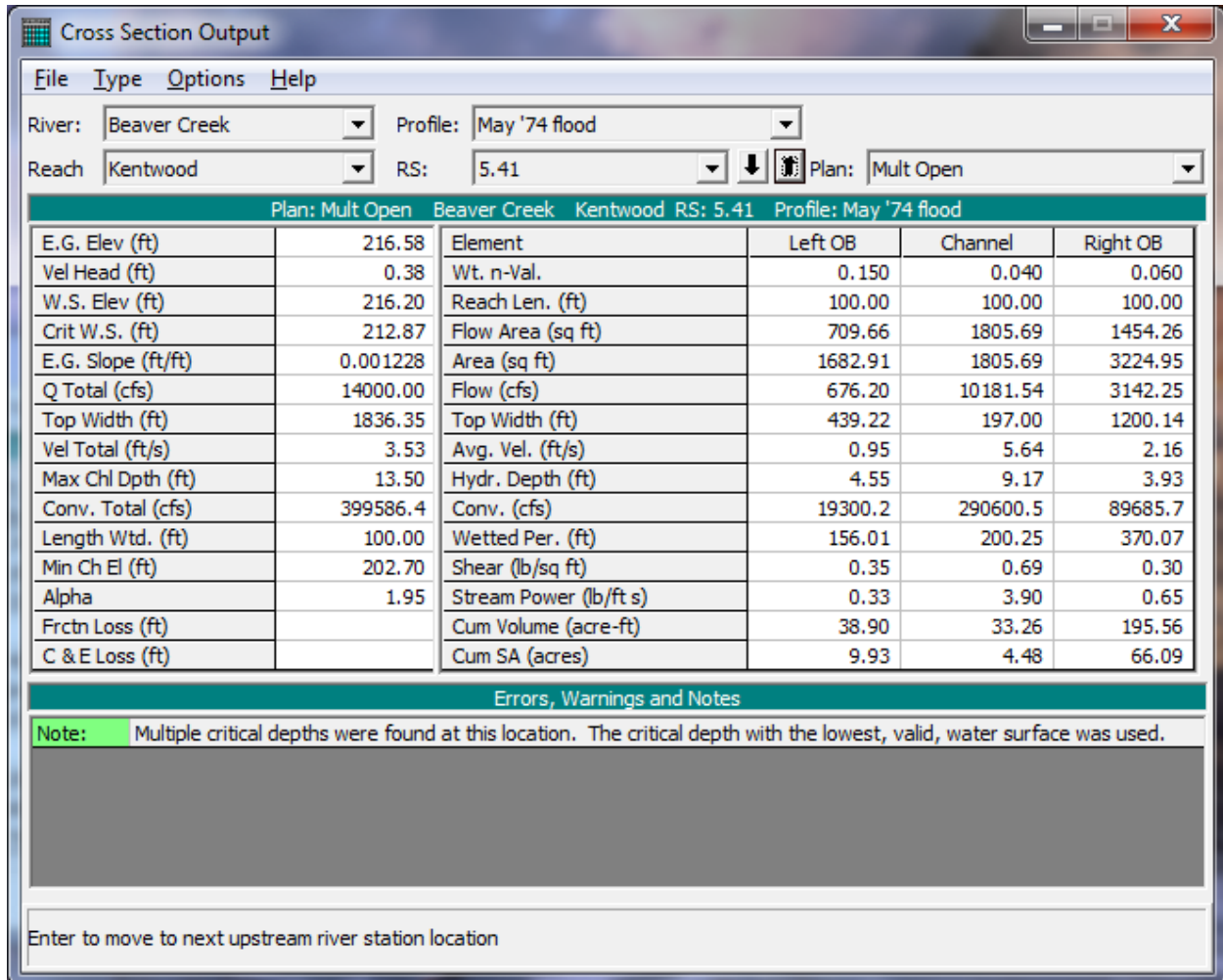

Figure 5-11: Cross Section Table for Profile 3, River Station 5.41

## Summary

The geometry of Example 2 was modified to prevent weir flow from occurring over the main bridge decking. This was accomplished by defining a culvert group and a relief bridge on the left and right side of the main bridge, respectively. These additional openings lowered the water surface upstream of the bridge so that weir flow did not occur. Figure 5.12 shows a comparison of the third water surface profile for the multiple opening and for the original river reach with just the main bridge. To develop the figure, select **View** and then **Water Surface Profiles** from the main program window. Then select **Options** and **Plans** and choose both of the plans. Finally, **Options** and

**Profiles** were chosen and only the third profile was selected to be plotted. This resulted in the display shown in Figure 5.12, which clearly shows that the modified conditions decreased the upstream water surface profile so that no weir flow occurred.

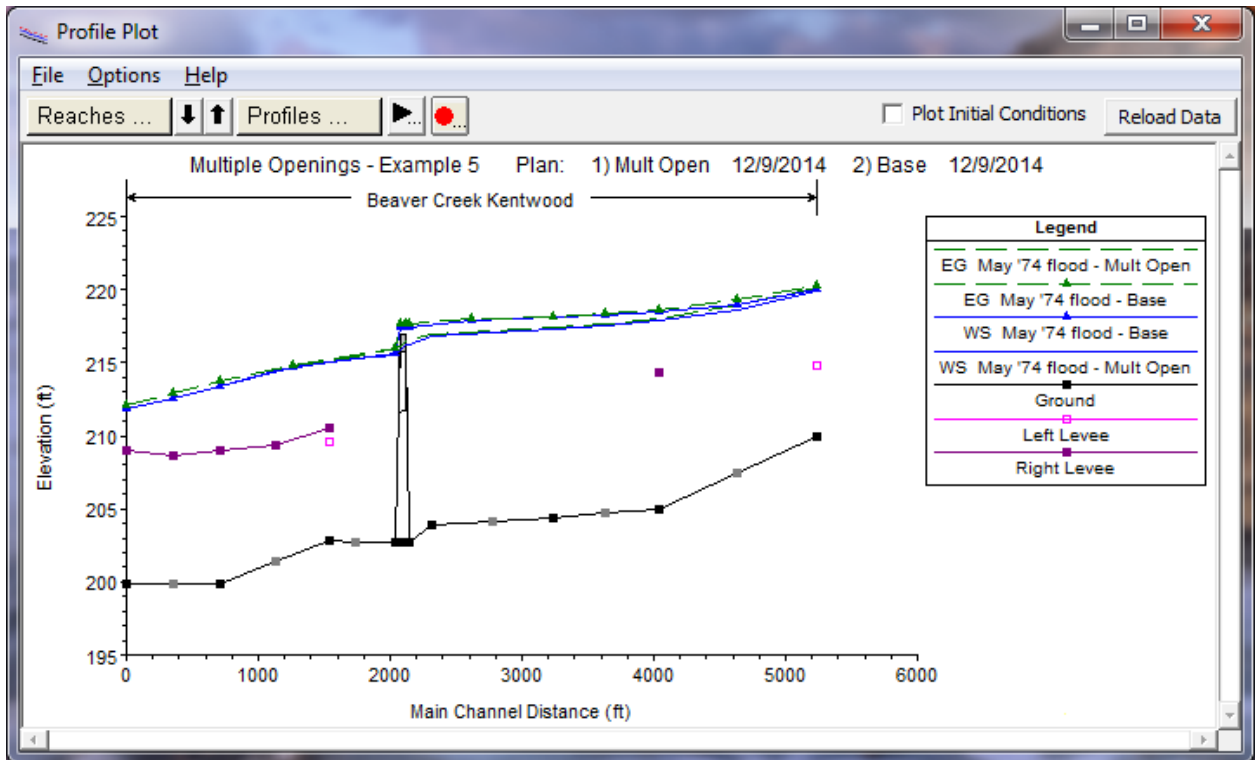

Figure 5-12: Third Flow Profile for Base Conditions vs. Multiple Openings Plans

After the analysis was performed, the user can review the flow parameters for the culvert and the relief bridge and adjust the size of these openings to develop the most practical alternative to prevent the weir flow from occurring. To compare the results in tabular format, from the main program window select **View** and then **Profile Table**. **Standard Table 1** was then selected from the **Std. Tables** menu. Finally, both of the plans and only the third profile were selected from the **Options** menu and this resulted in the table as shown in Figure 5.13.

By comparing the values in the table, the user can obtain required information to assist in the determination of any changes that may be necessary. For example, as can be seen in Figure 5.13, the change in the water surface elevation at river station 5.41 was 1.23 feet (from 217.43 to 216.20 feet). The modeler can use this information to determine if any additional decrease is necessary.



Profile Output Table - Standard Table 1												
HEC-RAS River: Beaver Creek Reach: Kentwood Profile: May '74 flood												Reload Data
Reach	River Sta	Profile	Plan	Q Total (cfs)	Min Ch El (ft)	W.S. Elev (ft)	Crit W.S. (ft)	E.G. Elev (ft)	E.G. Slope (ft/ft)	Vel Chnl (ft/s)	Flow Area (sq ft)	Top Width (ft)
Kentwood	5.61	May '74 flood	Mult Open	14000.00	204.40	217.30	213.62	217.38	0.000902	4.93	7969.12	1867.70
Kentwood	5.61	May '74 flood	Base	14000.00	204.40	218.09	213.62	218.14	0.000550	4.03	9490.83	1988.37
Kentwood	5.525*	May '74 flood	Mult Open	14000.00	204.15	217.03	214.37	217.15	0.000849	5.06	7717.30	1884.42
Kentwood	5.49*	May '74 flood	Base	14000.00	204.07	217.90	214.40	217.98	0.000441	3.91	9438.63	1910.06
Kentwood	5.44	May '74 flood	Mult Open	14000.00	203.90	216.76	214.21	216.92	0.000777	4.98	7362.81	1841.00
Kentwood	5.41	May '74 flood	Mult Open	14000.00	202.70	216.20	212.87	216.58	0.001228	5.64	3969.61	1836.35
Kentwood	5.41	May '74 flood	Base	14000.00	202.70	217.43	212.25	217.67	0.000727	4.72	8972.69	1846.98
Kentwood	5.4		Mult Open									
Kentwood	5.39	May '74 flood	Mult Open	14000.00	202.70	215.55	212.62	215.96	0.001492	5.92	3813.92	1697.49
Kentwood	5.39	May '74 flood	Base	14000.00	202.70	215.62	212.26	216.04	0.001552	6.07	6632.23	1702.87
Kentwood	5.33*	May '74 flood	Mult Open	14000.00	202.76	215.26	212.53	215.42	0.001241	5.08	6207.14	1648.26
Kentwood	5.29	May '74 flood	Mult Open	14000.00	202.80	215.03	211.45	215.16	0.001253	4.62	5827.75	1608.30
Kentwood	5.24*	May '74 flood	Base	14000.00	201.83	214.64	211.52	214.77	0.001312	5.26	5817.21	1633.34
Kentwood	5.21*	May '74 flood	Mult Open	14000.00	201.35	214.42	211.58	214.59	0.001516	5.91	5779.21	1644.68
Kentwood	5.13	May '74 flood	Mult Open	14000.00	199.90	213.33	211.50	213.76	0.002578	8.40	5017.23	1430.07

Total flow in cross section.

Figure 5-13: Standard Table 1 for Base and Modified Plans, Third Profile



## CHAPTER 6

# Floodway Determination

### Purpose

This example demonstrates the use of HEC-RAS to perform a floodplain encroachment analysis. Floodplain and floodway evaluations are of substantial interest to planners, land developers, and engineers, and are the basis for floodplain management programs. Most of the studies are conducted under the National Flood Insurance Program and follow the procedures in the "Flood Insurance Study Guidelines and Specifications for Study Contractors," FEMA 37 (Federal Emergency Management Agency, 1985).

FEMA 37 defines a floodway "...as the channel of a river or other watercourse and the adjacent land areas that must be reserved in order to discharge the base flood without cumulatively increasing the water-surface elevation by more than a designated height." Normally, the base flood is the one-percent chance event (100-year recurrence interval), and the designated height is one foot, unless the state has established a more stringent regulation for maximum rise. The floodway is usually determined by an encroachment analysis, using an equal loss of conveyance on opposite sides of the stream. For purposes of floodway analysis, the floodplain fringe removed by the encroachments is assumed to be completely blocked.

For this example, the floodplain encroachment analysis was performed to determine the maximum encroachment possible, constrained by a 1 foot maximum increase in water surface elevation from the natural profile. The geometric data used in this example are identical to the cross-section and bridge geometric data used in Example 2.

To review the data files for the current example, from the main HEC-RAS window, select **File** and then **Open Project**. Go to the directory in which you have installed the HEC-RAS example data sets. From the "Applications Guide\Chapter 6 – Floodway Determination" subdirectory, select the project labeled "Floodway Determination - Example 6." This will open the project and activate the following files:

Plan:	"Method 5 Encroachment"
Geometry:	"Existing Conditions"
Flow:	"Base + 1 ft Target Depth"

## Floodplain Encroachment Analysis Procedure

Currently, the HEC-RAS program has 5 methods to determine floodplain encroachments. These methods are:

Method 1 - User enters right and left encroachment stations

## Example 6 Floodway Determination

- Method 2 - User enters fixed top width
- Method 3 - User specifies the percent reduction in conveyance
- Method 4 - User specifies a target water surface increase
- Method 5 - User specifies a target water surface increase and maximum change in energy

For a detailed discussion on each of these methods, the user is referred to Chapter 9 of the Hydraulic Reference Manual.

The goal of performing a floodplain encroachment analysis is to determine the limits of encroachment that will cause a specified change in water surface elevation. To determine the change in water surface elevation, the program must first determine a natural profile with no encroachments. This base profile is typically computed using the one percent chance discharge. The computed profile will define the floodplain, as shown in Figure 6.1. Then, by using one of the 5 encroachment methods, the floodplain will be divided into

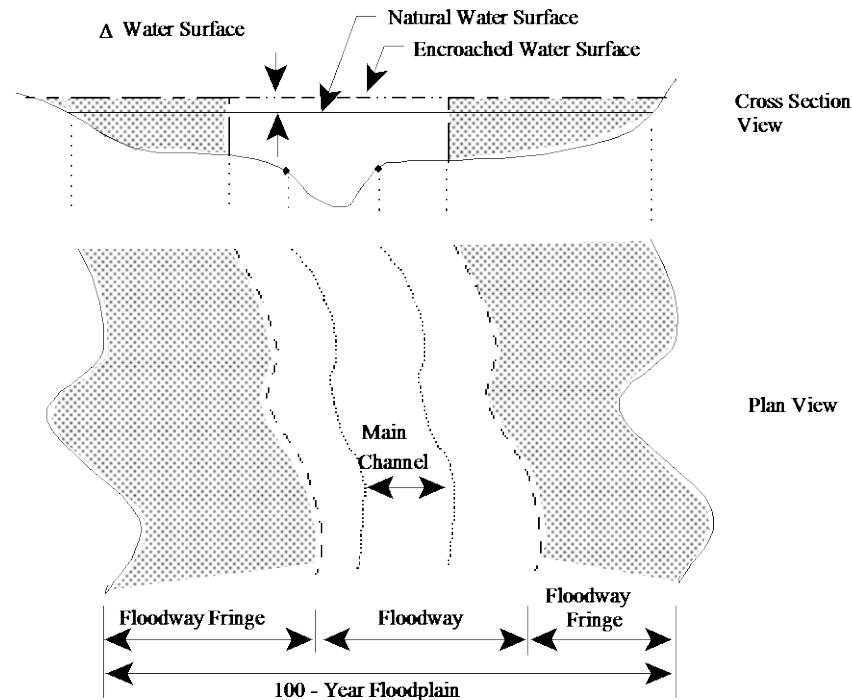

Figure 6-1: Floodway Definition Sketch

two zones: the floodway fringe and the floodway. The floodway fringe is the area blocked by the encroachment. The floodway is the remaining portion of the floodplain in which the one-percent chance event must flow without raising the water surface more than the target amount.

For this example, the following procedure was employed to perform the encroachment analysis:

- Determine the 100-year flood profile
- Method 5 optimization procedure

- Method 4 - with 3 target depths
- Method 4 - with 1 target depth
- Method 1 - final delineation of floodway
- Review of floodway delineation sketch

To perform the floodplain encroachment analysis for this example, the first step was to develop a model of the river reach that would compute the 100-year flood profile. This model must be developed and calibrated to the fullest extent possible because it defines the base flood elevations and all subsequent calculations will be based upon this profile. This was accomplished in Example 2.

After the base profile was computed, the Method 5 procedure was chosen as an initial attempt to calculate the encroachments. Method 5 will typically calculate reasonable encroachment stations for "well behaved" streams. That is, for streams that exhibit minor changes in cross section geometry and have small losses due to bridges and culverts. If the river reach has abrupt changes in geometry or orientation, contains a flow controlling structure, or the encroachments encounter the main channel bank stations, then Method 5 may produce erratic results at these locations.

If Method 5 produces inconsistent results, then Method 4 may be utilized. Method 4 is frequently used for a floodplain encroachment analysis. The initial approach is to use this method with several target water surface increases.

Finally, after the results are obtained from the Method 4 analysis, Method 1 was used to further refine the encroachment stations. The modeler should sketch the floodway on a topographic map to visually inspect the floodway and allow for smooth transitions. The computed floodway is considered preliminary, in that the regulating community must approve and adopt.

Each of these steps, as performed for this example, are discussed in detail in the following sections.

## **Base Flood Profile**

To perform the floodway analysis, the user must first determine the natural (existing conditions) 100-year flood water surface profile for the river reach. Therefore, a model of the existing river system must first be developed and calibrated to the fullest extent possible.

For this current example, the river reach and bridge geometric data of Example 2 were used. During Example 2, the HEC-RAS program was used to develop a calibrated model of the "Kentwood" Reach of Beaver Creek for a flow of 14000 cfs. During the analysis of that flood event, it was determined that the pressure/weir method produced water surface values that were comparable to the observed data. Verification that the model is adequately modeling the river system is an important step before starting the floodway analysis. For this example, the pressure/weir geometry file from Example 2 was used. This file was renamed to be "Existing Conditions" and was used for all of the plans developed here.

## Method 5 Optimization Procedure

In general, when performing a floodway analysis, encroachment Methods 4 and 5 are normally used to get a first cut at the floodway. For this example, Method 5 was used as an initial attempt to determine the encroachment stations. Encroachment Method 5 is an optimization scheme that will use a target increase in the water surface elevation and/or a maximum limit for the increase in energy to obtain the encroachment stations. The program will attempt to meet the target water surface while maintaining an increase in energy that is less than the maximum.

### Method 5 Steady Flow Data

To perform the Method 5 encroachment analysis, the flow data were first entered. From the main program window, select **Edit** and then **Steady Flow Data**. This activated the **Steady Flow Data Editor**. For the Method 5 analysis, 2 water surface profiles were chosen to be calculated. The first profile was used to determine the base profile and the second profile was used to determine the encroached profile. The flow values for both of the profiles were entered as 14000 cfs, the flow value that the model was calibrated. Then, the **Boundary Conditions** icon was selected and the **Downstream Known Water Surface** elevations were entered as 211.8 and 212.8. The first downstream boundary condition (211.8) was determined during Example 2. The second downstream boundary condition (212.8) was set at 1 foot higher to coincide with the maximum possible change in downstream water surface elevation. This accounted for the possibility of future encroachments downstream of the modeled reach. Finally, the steady flow data was saved as "Base + 1 ft Target Depth."

### Method 5 Encroachment Data

To enter the data for encroachment Method 5, from the main program window select **Run, Steady Flow Analysis, Options**, and then **Encroachments**. This will activate the **Encroachments Data Editor** as shown in Figure 6.2. The editor and the entering of data is divided into the following sections: global information; reach and river station information; and method and target values. The following sections describe each of the data entry items. For a further discussion of the data entry procedure, the user is referred to Chapter 9 of the **User's Manual**.

	River Sta	Method	Value 1	Value 2
1	5.99	5	1	1.2
2	5.875*	5	1	1.2
3	5.76	5	1	1.2
4	5.685*	5	1	1.2
5	5.61	5	1	1.2
6	5.49*	5	1	1.2
7	5.41	5	1	1.2
8	5.4 BR			
9	5.39	5	1	1.2
10	5.24*	5	1	1.2
11	5.13	5	1	1.2
12	5.065*	5	1	1.2
13	5.0	5	1	1.2

Figure 6-2: Encroachment Data Editor – Method 5 Analysis

Global Information. The global information is applied to all of the reaches and cross sections that will be selected for the analysis. The first input for the global information is the **Equal Conveyance Reduction** box. If this box is selected, then the program will encroach by simultaneously removing an equal amount of conveyance on both sides of the main channel. As the amount of conveyance is removed, if one of the encroachments reaches the main channel bank station (or the offset), then the program will continue to encroach on the other side until the target values are obtained or until the encroachment on the other side reaches the main channel bank station (or the offset). If the equal conveyance box is not selected, then the program will encroach by maintaining a loss of conveyance in proportion to the distribution of the natural overbank conveyance. The equal conveyance reduction applies to Methods 3, 4, and 5; and, for this example, the option was selected.

The next global information items are the **Left bank offset** and the **Right bank offset**. These offsets limit the distance of the encroachments. Without an offset, encroachments can go up to the bank stations, eliminating the entire overbank. For this example, the offsets were set to be 10 feet for both the left and right bank. Therefore, the limit of encroachment was 10 feet to the left of the left channel bank station and 10 feet to the right of the right channel bank station.

**Reach and River Station Information.** The next items to select in the encroachments editor are the **River** and **Reach** that will be analyzed. For this example, there is only one river and reach: the "Kentwood" reach on the river "Beaver Creek." Next, the **Starting River Station** and **Ending River Station** were entered. The analysis was set to begin at river station 5.99 and end at river station 5.00, the entire river reach. Finally, the **Profile** was selected. For a Method 5 analysis, only 2 profiles are necessary. The first profile will be used to determine the base water surface profile and cannot be selected in the encroachments data editor. The second profile is selected to be used for the Method 5 analysis.

**Method and Target Values.** Method 5 was selected for this analysis. When a method is selected, the data entry fields required for that method will appear immediately under the method field. For Method 5, the fields **Target WS change (ft)** and **Target EG change (ft)** appeared. A target water surface change of 1.0 foot and a target energy change of 1.2 feet were entered. Typically, the energy target will be chosen to be slightly greater than the water surface target. The energy target will act as an upper limit during the iterations to prevent the encroachment from getting very large.

The next step is to select the range of the river reach that will be analyzed, for the target values that were entered. For this example, the **Set Selected Range** button was selected and this applied Method 5 and the chosen targets to the selected range of river stations 5.99 to 5.00 for the Beaver Creek reach. By selecting this button, the fields in the table were filled with the corresponding method and values. In the table, since Method 5 was selected, the heading **Value 1** corresponds to the target water surface change and **Value 2** corresponds to the target energy change. When other methods are selected, the value 1 and value 2 columns will represent the specific data input items for the method. (Note: Some methods only require 1 value.) As a final note, the user can now edit the data table and change any of the methods and value items for any specific river station. For this example, the table was not edited at this time.

The **OK** button was then selected at the bottom of the encroachment editor. This prompted the **Steady Flow Analysis Window** to appear. Then the geometry file "Existing Conditions" and the steady flow file "Base + 1 ft Target Depth" were saved as the plan "Method 5 Encroachment." Finally, the Short ID was entered as "M5" and the **COMPUTE** button was selected for the subcritical flow analysis.

### Method 5 Output Review

The output of the encroachment analysis can be viewed both graphically and in tabular format. For this analysis, the encroachment data tables were reviewed. From the main program window, select **View, Profile Summary Table**, and then **Std. Tables**. The program generates 3 encroachment tables, with each table providing some of the same information and additional data. For this analysis, select **Encroachment 1**. A portion of this table is shown in Figure 6.3. The figure displays the bottom portion of the table.

The table is divided into sets of rows, with each set containing two rows. The first row in each set is for the un-encroached profile and the second row is for the encroached profile. Columns one and two show the reach and river stations and the third column shows the calculated water surface elevation.



The fourth column shows the difference between the first profile and each of the encroached profiles. Starting at river station 5.00 (at the bottom of the table), the difference in the water surface elevations for the encroached profile is 1 foot because the downstream boundary condition set the elevation change of 1 foot.

Review of the method 5 results shows that the method provided reasonable results up to the bridge to river station 5.39. However, at the bridge the method produced a negative surcharge. Further upstream, the encroachment method produced results up to the 1.0 foot allowable rise. This method had difficulty determining the encroachments around the bridge because the bridge hydraulics performed like a local control. This will be discussed further in the Method 4 analysis.

From the analysis of the Method 5 output, it was determined that the results were not acceptable upstream of the bridge and an alternate procedure should be then undertaken. The results from Method 5 up to the bridge could be used as a starting point for future analysis with a different method.

Reach	River Sta	Profile	W.S. Elev (ft)	Prof Delta WS (ft)	E.G. Elev (ft)	Top Width Act (ft)	Q Left (cfs)	Q Channel (cfs)	Q Right (cfs)	Enc Sta L (ft)	Ch Sta L (ft)	Ch Sta R (ft)	Enc Sta R (ft)
Kentwood	5.4	BR U PF#1	217.43		217.67	1846.98	739.47	11270.87	1985.41		450.00	647.00	
Kentwood	5.4	BR U PF#2	217.35	-0.08	217.71	978.55	246.25	12239.88	1521.45	313.68	450.00	647.00	1292.23
Kentwood	5.4	BR D PF#1	217.43		217.67	1824.00	739.47	11270.87	1985.41		450.00	647.00	
Kentwood	5.4	BR D PF#2	217.35	-0.08	217.71	978.55	246.25	12239.88	1521.45	313.68	450.00	647.00	1292.23
Kentwood	5.39	PF#1	215.62		216.04	1702.87	1073.65	10252.92	2673.43		450.00	647.00	
Kentwood	5.39	PF#2	216.29	0.68	216.74	978.55	505.38	10972.04	2522.58	313.68	450.00	647.00	1292.23
Kentwood	5.24*	PF#1	214.64		214.77	1633.34	2335.75	2506.36	9157.89		200.30	257.00	
Kentwood	5.24*	PF#2	215.63	0.99	215.74	981.75	2086.96	2398.17	9514.87	85.70	200.30	257.00	1067.45
Kentwood	5.13	PF#1	213.33		213.76	1430.02	1102.71	4951.45	7945.84		155.00	213.00	
Kentwood	5.13	PF#2	214.33	1.00	214.94	515.11	216.46	5883.80	7899.74	145.00	155.00	213.00	660.11
Kentwood	5.065*	PF#1	212.54		212.88	1781.77	1624.37	5359.43	7016.20		274.50	365.50	
Kentwood	5.065*	PF#2	213.54	1.00	214.03	642.15	167.71	6493.50	7338.80	264.50	274.50	365.50	906.65
Kentwood	5.0	PF#1	211.80		212.05	1925.36	2217.73	5187.01	6595.27		394.00	518.00	
Kentwood	5.0	PF#2	212.80	1.00	213.18	912.57	127.69	6544.90	7327.42	384.00	394.00	518.00	1296.57

Calculated water surface from energy equation.

Figure 6-3: Encroachment Table 1 for Method 5 Analysis

## Method 4 Encroachment Analysis - Trial 1

An alternative approach to perform the encroachment analysis is to use Method 4. The Method 4 analysis is similar to Method 5, without the iterative solution technique. To perform the Method 4 analysis, the program uses the following procedure:

- 1) First, the program computes the base water surface profile by using the data from the first profile in the steady flow data editor. With this profile, the

program calculates (among other parameters) the water surface profile and the conveyance for each river station.

2) For the second profile, starting at the first river station, the program takes the user supplied target water surface increase and adds this value to the base water surface elevation. With the increased water surface elevation, the program calculates the new conveyance at this river station. (Note: The first river station is located at the downstream end of the river system for a subcritical flow analysis.)

3) The program then determines the increase in conveyance between the base profile and the increased water surface profile. One half of this increase in conveyance will be removed from each side of the cross section fringe, if the equal conveyance option was selected. If the equal conveyance option was not selected, then the program will remove the conveyance from both sides in proportion to the natural conveyance. In either case, the difference of conveyance will be removed from the cross section, if possible.

4) To remove the conveyance, the program starts at the limits of the increased water surface profile and encroaches on both sides towards the main channel. As the conveyance is removed from both sides, the program checks to determine if the encroachment has reached the main channel bank station (or the offset) on that side. If the main channel bank station (or offset) is encountered, then the program will stop encroaching on that side and will make up the difference on the other side. If the encroachment on the other side encounters the main channel bank station (or offset), then the program can no longer continue to encroach.

5) Once the increase in conveyance has been removed from the cross section, with the higher water surface elevation, the encroachment stations are set. Also, the conveyance at the cross section with the higher water surface is now the same as the original conveyance at the cross section (if possible). Then the program uses the new geometry of the encroached cross section to determine the depth of flow at that cross section. Since the geometry of this river station has changed, the value of the friction slope and velocity head will change. Also, the magnitude of the expansion or contraction losses will change. Therefore, when the program calculates the water surface elevation with the new geometry, the depth of flow will typically be different than the target value entered by the user. In other words, even though the total conveyance is the same at this river station, the geometry, friction slope, and energy losses are different and this will produce a different flow depth at this river station. Often, the resulting depth of flow will be greater than the target increase in water surface elevation. Therefore, the first run with Method 4 is typically applied with several target values, usually smaller than the maximum increase.

6) The program then moves to the next river station and steps 2 through 5 are repeated. This process continues until the last river station is evaluated.

### **Method 4 Steady Flow Data - Trial 1**

To perform the Method 4 encroachment analysis, the flow data was first entered. The **Steady Flow Data Editor** was activated and 4 water surface profiles were chosen to be calculated. The first profile is still the base profile. The second, third and fourth profiles were used to determine the encroached

profiles with different target depths. The flow values for all of the profiles were entered as 14000 cfs, the 1 percent chance flood event. Then, the **Boundary Conditions** icon was selected and the **Downstream Known**

**Water Surface** elevations were entered as 211.8, 212.8, 212.8, and 212.8. The first downstream boundary condition (211.8) was determined during Example 2. The other downstream boundary conditions (212.8) were set 1 foot higher to coincide with the maximum possible change in downstream water surface elevation. This accounted for the possibility of future encroachments downstream of the modeled reach. Finally, the steady flow data was saved as "Base + 3 Target Depths."

#### Method 4 Encroachment Data - Trial 1

The Method 4 encroachment data were then entered, similar to that for Method 5. First, the **Encroachment Data Editor** was selected from the **Options** menu of the **Steady Flow Analysis** window. The encroachment editor is shown in Figure 6.4. Then, the global information of equal conveyance reduction and a 10 foot left and right offset were selected. The reach was selected as "Kentwood" and the starting and ending river stations were set as 5.99 and 5.00, respectively. Next, profile 2 and Method 4 were selected. Since Method 4 was chosen, this caused the data entry box **Target WS change (ft)** to appear. A target value of 0.8 feet was then entered and the **Set Selected Range** button was chosen. This filled in the table with the Method 4 and 0.8 foot change in water surface for the entire reach. Finally, the target value for river station 5.00 was changed to 1.0 foot. This will assume that the encroachment matched the target water surface of the downstream boundary condition. If the modeler is aware of the actual water surface increase at this river station (from other encroachment analyses), then this value should be used. Typically, this information is not known and therefore the modeler should include river stations below the area of interest so that the boundary conditions do not effect the region of the study.

Next, **Profile 3** was selected by depressing the down arrow adjacent to the profile field. Then **Method 4** was chosen and a **Target WS change (ft)** of 0.9 feet was entered. The **Set Selected Range** button was selected and this filled in the table with Method 4 and target values of 0.9 feet for the selected range. Then, the target value at river station 5.00 was changed to 1.0 foot, as performed previously. This procedure was repeated once more with the fourth profile for Method 4 and a target water surface change of 1.0 foot. The user should note that this method only requires one data input item and, therefore, the data will appear under "Value 1" of the table. The **OK** button was then selected to close the encroachment editor.

Finally, the geometry file "Existing Conditions" and the steady flow data file "Base + 3 Target Depths" were saved as a plan entitled "Method 4 Encroachment - Trial 1." The **Short ID** in the **Steady Flow Analysis Window** was entered as "M4 - Trial 1." This identification will assist the user when analyzing the output. Then, the **COMPUTE** button was selected to perform the calculations.

	River Sta	Method	Value 1	Value 2
1	5.99	4	0.8	
2	5.875*	4	0.8	
3	5.76	4	0.8	
4	5.685*	4	0.8	
5	5.61	4	0.8	
6	5.49*	4	0.8	
7	5.41	4	0.8	
8	5.4 BR			
9	5.39	4	0.8	
10	5.24*	4	0.8	
11	5.13	4	0.8	
12	5.065*	4	0.8	
13	5.0	4	1	

Figure 6-4: Encroachment Data Editor for Method 4 – Trial 1

### Method 4 Output - Trial 1

To review the output, the **Encroachment 1** table was selected and a portion of this table is shown as Figure 6.5. For each river station, there are four rows of data in the table. The first row is for the natural, un-encroached profile. The second, third, and fourth rows are for the second, third, and fourth profiles. These profiles were set with target values of 0.8, 0.9, and 1.0 foot, respectively (except for the first river station which had a constant target of 1.0 foot). The first non-fixed column of the table shows the water surface elevation for each profile. The second column displays the change in water surface from the natural profile for the encroached river station. Additional column headings show the calculated value of the energy gradeline, flow, calculated encroachment stations (by toggling to the right in the table), etc. Depending upon the required information, the user can select one of three encroachment tables. Further discussion of the encroachment tables is presented in Chapter 9 of the **User's Manual**.

Reach	River Sta	Profile	W.S. Elev (ft)	Prof Delta WS (ft)	E.G. Elev (ft)	Top Width Act (ft)	Q Left (cfs)	Q Channel (cfs)	Q Right (cfs)	Enc Sta L (ft)	Ch Sta L (ft)
Kentwood	5.13	PF#1	213.33		213.76	1430.02	1102.71	4951.45	7945.84		155.00
Kentwood	5.13	PF#2	214.27	0.94	214.79	595.61	204.92	5566.11	8228.98	145.00	155.00
Kentwood	5.13	PF#3	214.31	0.97	214.85	563.78	209.00	5679.41	8111.59	145.00	155.00
Kentwood	5.13	PF#4	214.34	1.01	214.91	535.76	212.87	5786.84	8000.29	145.00	155.00
Kentwood	5.065*	PF#1	212.54		212.88	1781.77	1624.37	5359.43	7016.20		274.50
Kentwood	5.065*	PF#2	213.55	1.01	213.96	771.05	159.40	6172.71	7667.89	264.50	274.50
Kentwood	5.065*	PF#3	213.55	1.00	214.00	707.53	163.69	6338.37	7497.94	264.50	274.50
Kentwood	5.065*	PF#4	213.54	1.00	214.03	640.47	167.81	6497.55	7334.64	264.50	274.50
Kentwood	5.0	PF#1	211.80		212.05	1925.36	2217.73	5187.01	6595.27		394.00
Kentwood	5.0	PF#2	212.80	1.00	213.18	912.57	127.69	6544.90	7327.42	384.00	394.00
Kentwood	5.0	PF#3	212.80	1.00	213.18	912.57	127.69	6544.90	7327.42	384.00	394.00

Calculated water surface from energy equation.

Figure 6-5: Encroachment Table 1 for Method 4 – Trial 1

For this review of the first run of Method 4, the main concern is with the change in water surface elevation. The encroachment process and resulting water surface elevations were determined using the 6 steps as described previously at the beginning of this section. For river station 5.00, the change in water surface was 1.0 foot for all of the target values because the downstream boundary conditions were set to be 1 foot higher than the base profile. At river station 5.13, the changes in water surface were 0.94, 0.97, and 1.01 feet for the target values of 0.8, 0.9, and 1.0 feet. This shows that the actual resulting water surface is generally greater than the target values. Further review of the table shows the various resulting water surface elevations for the target depths.

To continue the encroachment analysis process, a Method 4 analysis was again calculated, however this was performed with only 1 target depth for each river station. The target depths that were used in the subsequent analysis were the target depths that resulted in a water surface change as close to 1 foot without exceeding 1 foot. For example, at river station 5.13, the resulting change in water surface that is as close to 1 foot as possible without exceeding 1 foot is 0.97 feet. This value was obtained from a target increase of 0.9 feet from the third profile. Therefore, for the next trial, a target value of 0.9 was used at river station 5.13. Likewise, a target of 0.80 was used at river station 5.24\* because this target yielded a change in water surface of 0.94 feet. Table 6.1 shows the values that were used for the subsequent analysis.

Table 6-1: Selected Target Values

Station	Target	$\Delta$ WS from Trial 1
5.99	1.0	0.86
5.875*	1.0	0.67
5.76	1.0	0.58
5.685*	1.0	0.52
5.61	1.0	0.49
5.49*	1.0	0.43
5.41	1.0	0.17
5.40 (Bridge)	1.0	0.17
5.39	0.9	0.95
5.24*	0.8	0.94
5.13	0.9	0.97
5.065*	1.0	1.00
5.00	1.0	1.00

It should be noted that for the bridge river station (5.40), the user can only enter one target value into the encroachment data editor. Therefore, only one target value appears in Table 6.1. Additionally, since the pressure/weir option is being used as the high flow analysis method, the program will use the encroachments calculated at river station 5.39 as the encroachments for river stations 5.40 and 5.41. This will be discussed further in the proceeding section and additional discussion is provided in Chapter 9 of the **Hydraulic Reference Manual**.

## Method 4 Encroachment Analysis - Trial 2

The next step to define the encroachments was to again use a Method 4 analysis, but with only 1 target depth for each river station. To perform the analysis, a steady flow data file was first developed and then the encroachment data were entered. Finally, this section will review the output from the second run using the Method 4 analysis.

### Method 4 Steady Flow Data - Trial 2

Since this analysis only requires two profiles, the steady flow data file as developed for the Method 5 analysis was used. This file, "Base + 1 ft Target Depth," included only 2 profiles (14000 cfs each) and had the downstream known water surface boundary conditions set at 211.8 and 212.8 feet.

### Method 4 Encroachment Data - Trial 2

To enter the data for the second Method 4 analysis, the **Encroachment Data Editor** was activated from the **Steady Flow Analysis Window**. This encroachment editor is shown in Figure 6.6. As entered previously, the equal conveyance option was selected and a left and right offset of 10 feet were entered. The reach of "Kentwood" was selected (the only reach in this example) and the starting and ending river stations were 5.99 and 5.00, respectively, which included the entire river reach. Then the profile was selected as 2 (since the first profile is used to calculate the base profile).

For this analysis, Method 4 was selected for each river station and the target water surface values for each river station were obtained from Table 6.1, as

discussed previously. At this point, the user can enter the data directly into the table. A 4 was placed adjacent to each river station under the "Method" column and the target values for each river station were entered directly into the table under "Value 1," a portion of which is shown in Figure 6.6. (The remaining values can be observed by using the toggle arrows on the right side of the editor.) Finally, the **OK** button was selected to exit the data editor.

The screenshot shows the "Encroachments" dialog box. It has a checked option for "Equal Conveyance Reduction". Below this are input fields for "Left bank offset" (10) and "Right bank offset" (10). There are dropdown menus for "River" (Beaver Creek), "Profile" (PF#2), and "Reach" (Kentwood). A button "Import to Method 1 ..." is also present. A section titled "Set Range of Values" contains dropdowns for "Upstream RS" (5.99) and "Downstream RS" (5.0), a "Method" dropdown (none), and input fields for "Value 1" and "Value 2". A "Set Selected Range" button is located below these fields. At the bottom is a table with 5 columns: an index column, "River Sta", "Method", "Value 1", and "Value 2". The table contains 13 rows of data. At the very bottom of the dialog are buttons for "OK", "Cancel", "Clear Profile", and "Clear All Profiles".

	River Sta	Method	Value 1	Value 2
1	5.99	4	1	
2	5.875*	4	1	
3	5.76	4	1	
4	5.685*	4	1	
5	5.61	4	1	
6	5.49*	4	1	
7	5.41	4	1	
8	5.4 BR			
9	5.39	4	0.9	
10	5.24*	4	0.8	
11	5.13	4	0.9	
12	5.065*	4	1	
13	5.0	4	1	

Figure 6-6: Encroachment Data Editor for Method 4 – Trial 2

A new plan was created with the geometry data file "Existing Conditions" and the steady flow data file "Base + 1 ft Target Depth." These files were saved as the plan "Method 4 Encroachment - Trial 2." The **Short ID** was entered as "M4 - Trial 2" and the **COMPUTE** button was then selected.

### Method 4 Output - Trial 2

The output from the encroachment analysis can be viewed in either tabular or graphical form. For a tabular review, the user can select from 1 of 3 tables defined by the program (or the user can create a table). For this review, a portion of the **Encroachment 1 Table** is shown in Figure 6.7. (Note: The flow columns have been removed from the table in the text.)

Example 6 Floodway Determination

As described previously, the first non-fixed column is the resulting water surface elevation and the second column is the difference in the water surface profile from the first profile. The goal of this analysis is to determine the encroachments so that the resulting water surface does not change by more than 1 foot. As can be seen by the results in the table, the change of water surface for river stations 5.00 and 5.065\* are both 1.00 feet. For river station 5.13, the change in water surface is 1.01 feet. This value was obtained with a target value of 0.9 feet. Therefore, to decrease the resulting water surface elevations at this river station, the target value for this river station must be decreased and a subsequent Method 4 analysis performed. This iterative process of changing the target values and reviewing the output can determine the floodway that will result in a change of water surface less than 1 foot.

When performing a subcritical flow analysis, the user should begin this iterative process at the downstream cross section and work upstream. Additionally, the user should not attempt to adjust a large quantity of target values at the same time. For this example, the target values for the river stations below the bridge (5.00 through 5.29) were adjusted first. Then the bridge section was analyzed and finally the upstream river stations were adjusted. This procedure will allow the user to focus on specific river sections and adjust these target values before moving onto the further upstream river stations.

Reach	River Sta	Profile	W.S. Elev (ft)	Prof Delta WS (ft)	E.G. Elev (ft)	Top Width Act (ft)	Q Left (cfs)	Q Channel (cfs)	Q Right (cfs)	Enc Sta L (ft)	Ch Sta L (ft)
Kentwood	5.4	BR D PF#1	217.43		217.67	1824.00	739.47	11270.87	1985.41		450.00
Kentwood	5.4	BR D PF#2	217.52	0.09	217.94	704.54	26.46	12135.44	1838.01	440.00	450.00
Kentwood	5.39	PF#1	215.62		216.04	1702.87	1073.65	10252.92	2673.43		450.00
Kentwood	5.39	PF#2	216.54	0.93	217.10	704.54	29.12	12097.74	1873.14	440.00	450.00
Kentwood	5.24*	PF#1	214.64		214.77	1633.34	2335.75	2506.36	9157.89		200.30
Kentwood	5.24*	PF#2	215.66	1.02	215.83	725.77	833.92	2880.62	10285.46	159.15	200.30
Kentwood	5.13	PF#1	213.33		213.76	1430.02	1102.71	4951.45	7945.84		155.00
Kentwood	5.13	PF#2	214.35	1.01	214.89	563.78	208.38	5664.95	8126.67	145.00	155.00
Kentwood	5.065*	PF#1	212.54		212.88	1781.77	1624.37	5359.43	7016.20		274.50
Kentwood	5.065*	PF#2	213.54	1.00	214.03	640.47	167.81	6497.55	7334.64	264.50	274.50
Kentwood	5.0	PF#1	211.80		212.05	1925.36	2217.73	5187.01	6595.27		394.00
Kentwood	5.0	PF#2	212.80	1.00	213.18	912.57	127.69	6544.90	7327.42	384.00	394.00

Calculated water surface from energy equation.

Figure 6-7: Encroachment Table 1 for Method 4 – Trial 2

As an additional review of the encroachment 1 table, it can be seen that the left and right encroachment stations that were calculated for river station 5.39 were 440.00 and 1144.54. These encroachments were then used for river stations 5.40 and 5.41. This is a default method for the program since the pressure/weir method was used for the bridge high flow analysis. If the



energy method had been used, then the program would allow for separate encroachment stations throughout the bridge.

Finally, the left encroachment station of 440 at river station 5.39 is 10 feet to the left of the main channel bank station. Therefore, the program encroached up to the left offset on this side of the main channel. (This also occurred at river stations 5.00, 5.065\*, and 5.13.) If the offsets had not been used, then the left encroachment would have continued up to the main channel bank station. When this occurs, additional wetted perimeter will be added to the main channel. This will cause the conveyance of the main channel to decrease and the total loss of conveyance at the cross section may be greater than if the encroachment did not encounter the main channel. Therefore, this may reduce the amount of encroachment on the right side of the channel since an additional loss of conveyance had already occurred.

To determine the percent reduction of conveyance removed from each side, the **Encroachment Table 2** can be viewed. A portion of this table is shown as Figure 6.8. From the table, it can be seen that for river station 5.00, an approximately equal amount of conveyance was removed from each side of the main channel (15.43 and 15.53 percent for the left and right sides, respectively). This occurred even though the encroachment encountered the left offset. However, for river station 5.065\*, the encroachment also encountered the left offset but the percent reduction of left and right conveyance is not equal. The percent of conveyance removed at river station 5.065\* is 10.79 and 18.89 for the left and right sides, respectively. This implies that after the left encroachment reached the left offset, the program needed to remove an additional amount of conveyance from the left. Therefore, the program removed that amount from the right side in addition to the amount required to be removed from the right side. This caused the percent of conveyance removed to be unequal on both sides of the main channel.

Reach	River Sta	Profile	Prof Delta WS (ft)	Top Width Act (ft)	K Perc L	Enc Sta L (ft)	Dist Center L (ft)	Center Station (ft)	Dist Center R (ft)	Enc Sta R (ft)	K Perc R	Enc WD (ft)
Kentwood	5.4	BR D		1824.00				548.50				
Kentwood	5.4	BR D	0.09	704.54		440.00	108.50	548.50	596.04	1144.54		704.54
Kentwood	5.39	PF#1		1702.87				548.50				
Kentwood	5.39	PF#2	0.93	704.54	8.58	440.00	108.50	548.50	596.04	1144.54	11.79	704.54
Kentwood	5.24*	PF#1		1633.34				228.65				
Kentwood	5.24*	PF#2	1.02	725.77	11.39	159.15	69.50	228.65	656.27	884.92	11.39	725.77
Kentwood	5.13	PF#1		1430.02				184.00				
Kentwood	5.13	PF#2	1.01	563.78	6.49	145.00	39.00	184.00	524.78	708.78	18.43	563.78
Kentwood	5.065*	PF#1		1781.77				320.00				
Kentwood	5.065*	PF#2	1.00	640.47	10.79	264.50	55.50	320.00	584.97	904.97	18.89	640.47
Kentwood	5.0	PF#1		1925.36				456.00				
Kentwood	5.0	PF#2	1.00	912.57	15.43	384.00	72.00	456.00	840.57	1296.57	15.53	912.57

Difference in WS between current profile and WS for first profile.

Figure 6-8: Encroachment Table 2 for Method 4 – Trial 2

### **Method 4 Encroachment Analysis - Trial 3**

To further define the encroachments, an iterative process was performed by changing the target values at the river stations and then executing the Method 4 analysis. Before the iterative process was started, the data was saved as a plan entitled "Method 4 Encroachment - Trial 3." Then, as mentioned previously, the iterations were performed first for the river stations below the bridge (5.00 through 5.29), then the bridge vicinity was analyzed (5.39, 5.40, and 5.41), and finally the upstream river sections were evaluated (5.49\* through 5.99). The target values and resulting rise in water surface which yielded the most practical results are shown in Table 6.2.

Table 6-2: Final Target Values

Station	Target	$\Delta$ WS for M4 -Trial 3
5.99	0.60	1.00
5.875*	0.95	0.99
5.76	1.40	0.86
5.685*	1.80	0.72
5.61	2.00	0.62
5.49*	2.00	0.43
5.41	1.10	0.12
5.40 (Bridge)	1.10	0.12
5.39	1.10	1.00
5.24*	1.05	1.00
5.13	0.80	1.00
5.065*	0.95	1.00
5.00	1.00	1.00

The final target water surface values used and the resulting change in water surface are listed in Table 6.2. These values were obtained from the **Encroachment Table 1** as discussed previously.

In the vicinity of the bridge, a target value of 1.1 foot at river station 5.39 (just downstream of the bridge) was found to result in the most practical encroachments through the bridge. If a higher target value was used, the program would encroach further towards the main channel and a slightly higher water surface value would be obtained at river stations 5.39, 5.40, and 5.41. If the encroachments at the bridge were moved closer to the main channel, then this would further increase the upstream water surface. The increase in upstream water surface is in effect before the upstream encroachments are calculated. Therefore, the upstream encroachments are limited from the start because the upstream water surface elevation is already greater than the natural profile.

As the target value at river station 5.39 was increased beyond 1.1, the program could only provide minor encroachment distances at river station 5.49\*. This created an erratic transition in the floodway at river station 5.49\*. As a compensation between the bridge encroachment constriction and initial upstream rise, the target value of 1.1 foot at river station 5.39 was determined to be most practical.

Additionally, at river station 5.40 (the bridge) and 5.41, the change in water surface was only 0.11 feet. This water surface elevation only increased slightly due to two factors. First, the rise in water surface upstream of the bridge (river station 5.41) is controlled by the bridge structure itself, due to the occurrence of pressure and weir flow. The increase in water surface at section 5.39 did not cause enough submergence on the weir to increase the upstream headwater. Secondly, the conveyance reduction at 5.40 and 5.41 removed only the weir flow that was occurring. This reduction of weir flow was not sufficient enough to cause the water surface to rise dramatically. This implies that the pressure flow was dominate through the bridge opening. The modeler should check the bridge solution to determine the value of the pressure flow. For this example, the pressure flow through the bridge was 12179.63 cfs, a major portion of the total flow of 14000 cfs.

It should be emphasized that the Method 4 iterations were continued until a practical floodway was developed. After the Method 4 procedure was completed, the results were used in a Method 1 analysis which is discussed in the following section.

## **Method 1 Encroachment Analysis**

Typically, the floodplain encroachment method results are converted to Method 1 to perform minor adjustments for smoothing the floodplain. To perform a Method 1 analysis, the user must enter the left and right encroachment stations for each cross section. For this example, the encroachment stations as determined by the Method 4 iterative procedure were used for the Method 1 analysis. To perform the analysis, first the steady flow data was entered and then the encroachment data was entered. Finally, this section will discuss the output from the Method 1 analysis.

### **Method 1 Steady Flow Data**

For the Method 1 analysis, only 2 flow profiles were used. Therefore, the steady flow data file "Base + 1 ft Target Depth" was used for this analysis. This was the same file as used for the Method 5, the Method 4 - Trial 2, and the Method 4 - Trial 3 plans.

### **Method 1 Encroachment Data**

To enter the encroachment data, the **Encroachment Data Editor** was activated from the **Steady Flow Analysis** window. The encroachment editor was opened from the plan that contained the final Method 4 iterative results. Then, the **Import to Method 1** icon was selected. This option prompts the program to read the final encroachment results from the currently opened plan, and to automatically convert those output results to encroachment Method 1 input. Once the data appeared in the table, the **OK** button was selected. Then the geometric file "Existing Conditions" and the steady flow data file "Base + 1ft Target Depth" were saved as the plan "Method 1 Encroachment." The **Short ID** was entered as "M1" and the **COMPUTE** button was selected.

### **Method 1 Output**

The output from the Method 1 analysis should be identical to the output from the Method 4 iterative plan output. This was verified by comparing the resulting changes in water surface elevation at the river stations. At this point, the user can fine tune and adjust the encroachments as deemed necessary by adjusting the left and right encroachment stations in the **Encroachment Data Editor**. For this example, no further adjustments were made.

To review the output in graphical form, from the main program window select **View** and then **X-Y-Z Perspective Plots**. This will result in the display as shown in Figure 6.9. As can be seen in Figure 6.9, the encroachment stations appear to follow a smooth transition throughout the river reach. However,

the user must be aware of the fact that this plot is based upon the X-coordinates as entered by the user. If the X-coordinates for the cross sections are not all established from the same left baseline, then the plot may not be accurately portraying the correct configuration of the floodway. The modeler should sketch the resulting encroachments and floodway on a topographic map to view the correct alignment of the floodway. At this point, further refinement for the locations of the encroachments stations should be made.

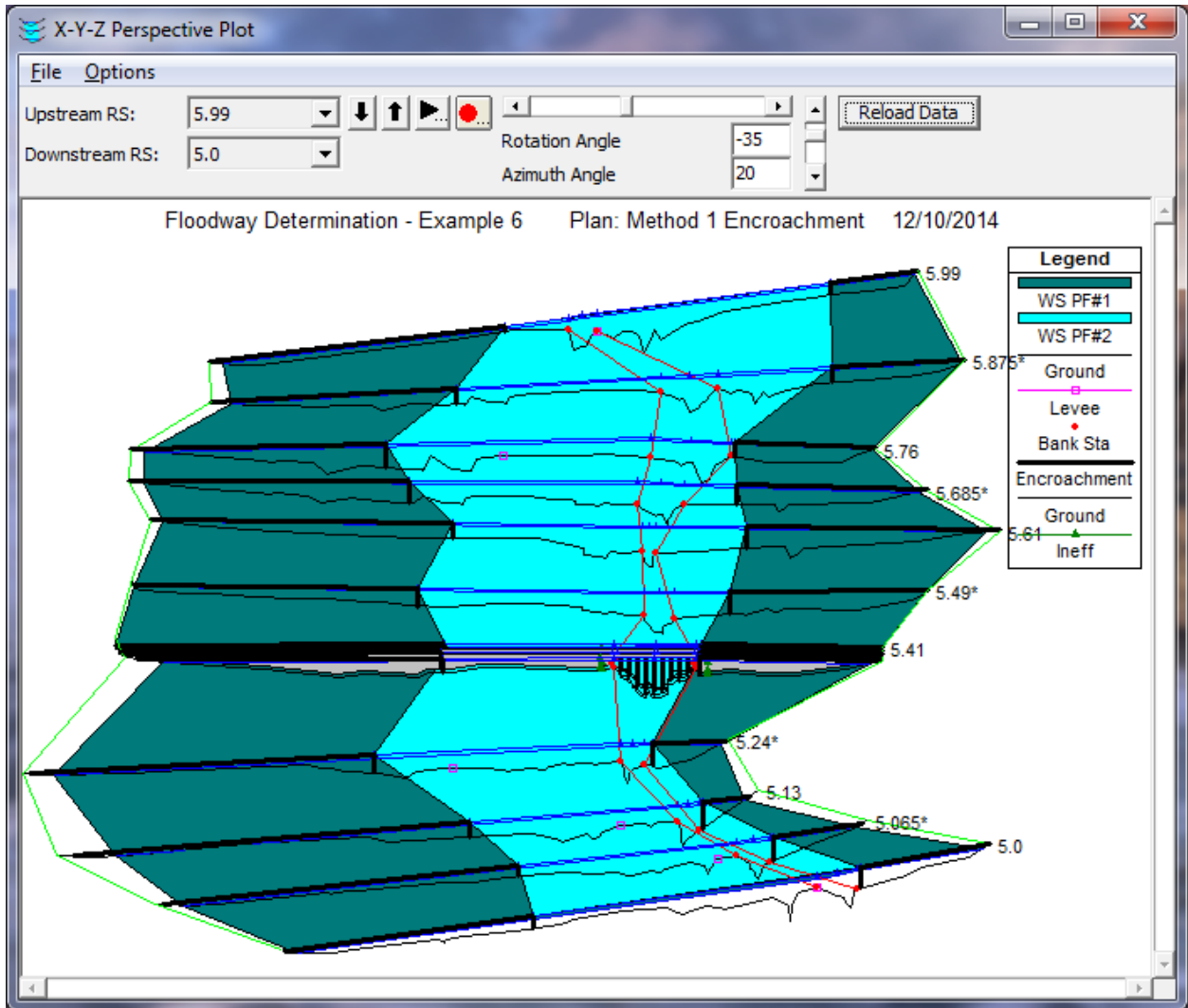

Figure 6-9: 3-D Perspective Plot of Method 1 Analysis

In addition to the 3-D plot, the user can also view the individual cross section plots to see the location of the encroachment stations. By using the information from the encroachment tables, the cross section plots, the 3D plot, and the user developed topographic plot, the encroachment stations should be evaluated for the required constraints and the transitions of the floodway.

## **Summary**

To perform the floodway analysis for this example, a Method 5 procedure was first attempted. This procedure can yield reasonable results for a smooth transitioning river reach. However, for this example, the bridge structure in the river reach caused difficulties in the Method 5 analysis and the program did not yield reliable results upstream of the bridge.

To continue the analysis, a Method 4 procedure was employed. First, 3 target depths were used to obtain a first cut at the encroachment stations. Then, the Method 4 procedure was employed iteratively with one target value for each river station to further define the encroachments. After the encroachments appeared to be well established, the results were imported to Method 1 for a final check on the encroachments and to perform any additional smoothing of the floodway transitions.

When performing a floodway analysis, the general approach is to attempt to encroach on both sides of the water course without increasing the water surface elevation by some predefined amount. The user should also be aware of other constraints such as velocity limits and equal conveyance reduction requirements, which may be constraining the floodway delineation. Additionally, the floodway must be consistent with local development plans and provide reasonable hydraulic transitions throughout the study reach. These transitions must be determined by plotting the encroachment stations onto a topographic map. The user should not rely on the 3-D plot provided with the program due to the constraints of the plot as described previously.

---

## CHAPTER 7

# Multiple Plans

### Purpose

This example will demonstrate the use of working with multiple plans. Each river hydraulics application constitutes a project, which is a collection of files that are associated with the application. A project is divided into one or more plans. Each plan associates specific files of the project to be grouped together. Therefore, each plan can represent a development stage or analysis phase of the project.

Initially, this example will briefly discuss the elements of a project and the elements of a plan. The modeler is referred to Chapter 5 of the User's Manual for a further discussion on working with projects and a discussion of the files that comprise a plan. Specifically, this example will illustrate the use of multiple plans by analyzing the existing geometric conditions of the river reach and then analyzing a proposed change to the geometry. To review the data files for this example, from the main HEC-RAS window, select **File** and then **Open Project**. Go to the directory in which you have installed the HEC-RAS example data sets. From the "Applications Guide\Chapter 7 – Multiple Plans" subdirectory, select the project labeled "Napa Cr. Bridge Project - Example 7." This will open the project and activate the following files:

Plan:	"Existing Plan Data"
Geometry:	"Existing Geometry"
Flow:	"100 year flow"

### Elements of a Project

A project is comprised of all of the files that are used to develop a model, as well as a list of default variables that are used for the analysis. The files that constitute the project are listed in Table 7.1. For each file, the table lists the file type, the file extension, and the method of creation of the files (by the user or by the program).

Table 7-1: Project Files

File Type	Extension	Created By:
Plan	.P##	user
Geometry	.G##	user
Steady Flow	.F##	user
Unsteady Flow	.U##	user
Sediment Data	.S##	user
Hydraulic Design	.H##	user
Run	.R##	program
Output	.O##	program

Note: ## refers to an extension number from 01 to 99.

As the file types are created, the program will number the extensions in consecutive order starting at 01. The run and output file extension numbers will always coincide with the extension number of the plan that the program used to create the files.

Finally, the project also specifies the default variables. These variables include the system of units (English or SI) and the contraction and expansion coefficients. These variables can be changed by the user through the program interface.

## Elements of a Plan

A project is comprised of one or more plans. Each plan contains: a short identifier; a list of files associated with the plan; and a description of the simulation options that were set for the analysis. Each of these three items are discussed as follows.

The short identifier is entered in the **Steady Flow Analysis Window**. This identifier appears while viewing the output. It is used to identify the output from a specific plan while viewing the output from multiple plans. If this identifier is changed, then the user must re-compute the plan in order for the output file to reflect the change.

The main function of the plan is to associate a group of files. The plan can associate one file extension from each type of file. For this example, there were two geometry files and one steady flow file that were created. The first geometry file was created to describe the existing conditions of the river reach and had an extension ".G01". The second geometry file described the proposed geometry of a new bridge along the same river reach and, since it was the second geometry file that was created, it had an extension ".G02."

Finally, a steady flow data file was created that contained the 100-year flow event. This steady flow file had an extension ".F01."

For this project, it was desired to compare the results of the existing geometry to the proposed geometry for the same flow event. Therefore, two plans were created. The first plan associated the existing geometry file (.G01) with the 100-year steady flow data (.F01). The second plan associated the proposed geometry (.G02) with the same 100-year steady flow data (.F01). In this manner, a second steady flow data file with the same information was not required to be developed. Instead, the second plan



merely associated the second geometry file with the original steady flow data file. After both plans were computed, the output from the first plan (.001) and the output from the second plan (.002) were then easily compared graphically and in tabular form. This will be discussed shortly.

It should be noted that a plan cannot contain a combination of a steady flow and an unsteady flow file. A plan can only include one type of file that contains flow information.

Lastly, the plan contains a description of the simulation options that were set for the analysis. These simulation options include: maximum tolerances for calculations, maximum number of iterations, log output level, friction slope method, etc. These simulation options can be changed by the user.

## Existing Conditions Analysis

The main focus of the remaining discussion will concentrate on the method of creating multiple plans and analyzing multiple plan output. The geometry and steady flow data files developed for this example are briefly discussed in the following sections.

### Existing Conditions Geometry

A geometry file was created that modeled the existing conditions for a reach of Napa Creek. This reach is a manmade channel with four bridge crossings. To view the river schematic, from the main program window select **Edit** and then **Geometric Data**. This will activate the **Geometric Data Editor** and display the river system schematic as shown in Figure 7.1.

The river reach is defined by 84 river stations. The user can view the geometric data for each river station by selecting the **Cross Section** icon from the **Geometric Data Editor**. The data for each river station is comprised of : a description; X and Y coordinates; downstream reach lengths, Manning's n values; main channel bank stations; and contraction and expansion coefficients.

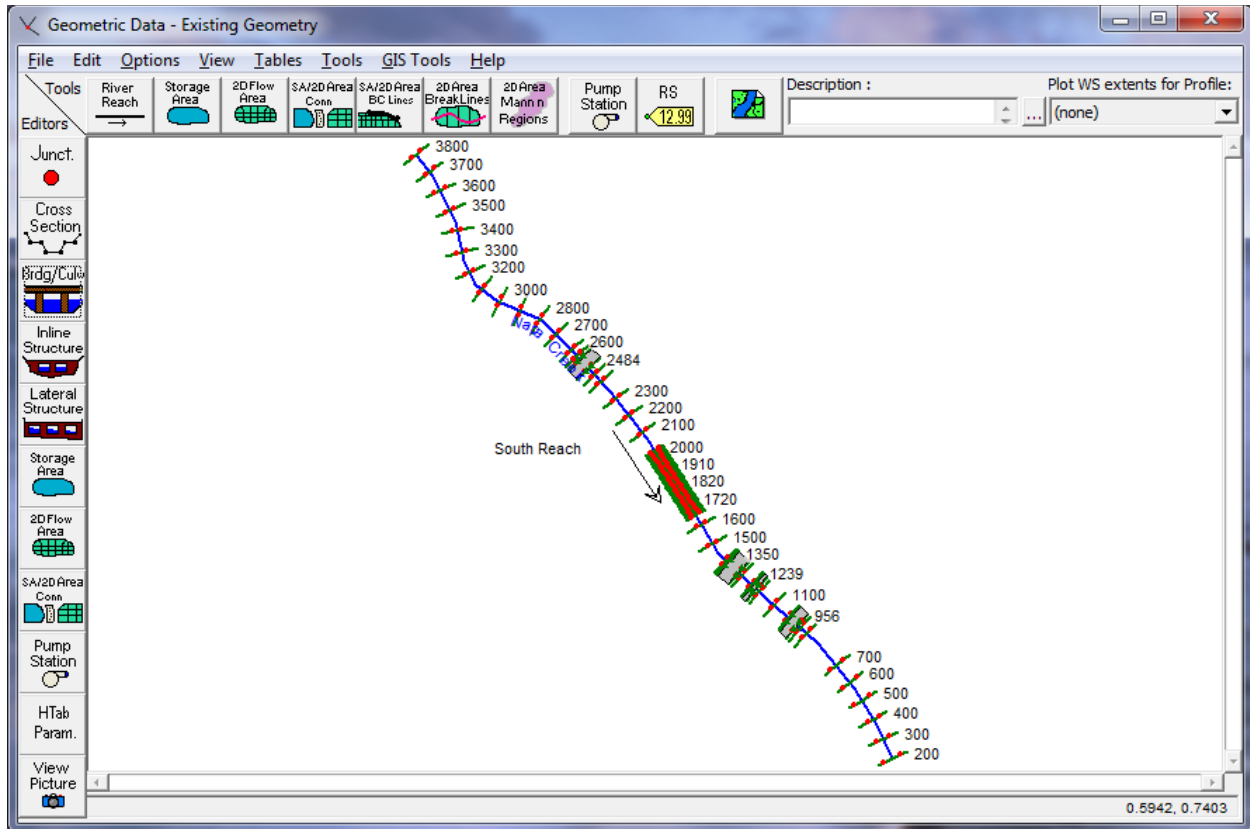

Figure 7-1: Napa Creek River System Schematic

Additionally, a levee was placed on the left side river stations 200 and 300 and ineffective flow areas were established at river stations: 956 and 1002; 1208 and 1229; 1318 and 1383; 2484 and 2540. Each of these four groupings are for the four bridge locations in the river reach. Finally, the expansion and contraction reach lengths for each bridge were estimated using the expansion and contraction ratios obtained from Table B.1 and B.2 in Appendix B of the **Hydraulic Reference Manual**.

The focus of this project is to replace the existing bridge structure located at river station 2512. To view the existing bridge, from the **Geometric Data Editor** select the **Bridge/Culvert** icon and toggle to river station 2512. This will display the Seminary Street Bridge at river station 2512 as shown in Figure 7.2.

The bridge deck and roadway information were entered by selecting the **Deck/Roadway** icon on the left side of the editor. Additionally, the **Bridge Modeling Approach** icon was selected and the appropriate information provided (These procedures were also applied to develop the other 3 bridges in the river reach).

After all of the geometric data were entered, the geometry file was saved. This was performed from the **Geometric Data Editor** by selecting **File** and then Save Geometry Data As. The title was entered as "Existing Geometry" and the **OK** button was selected.

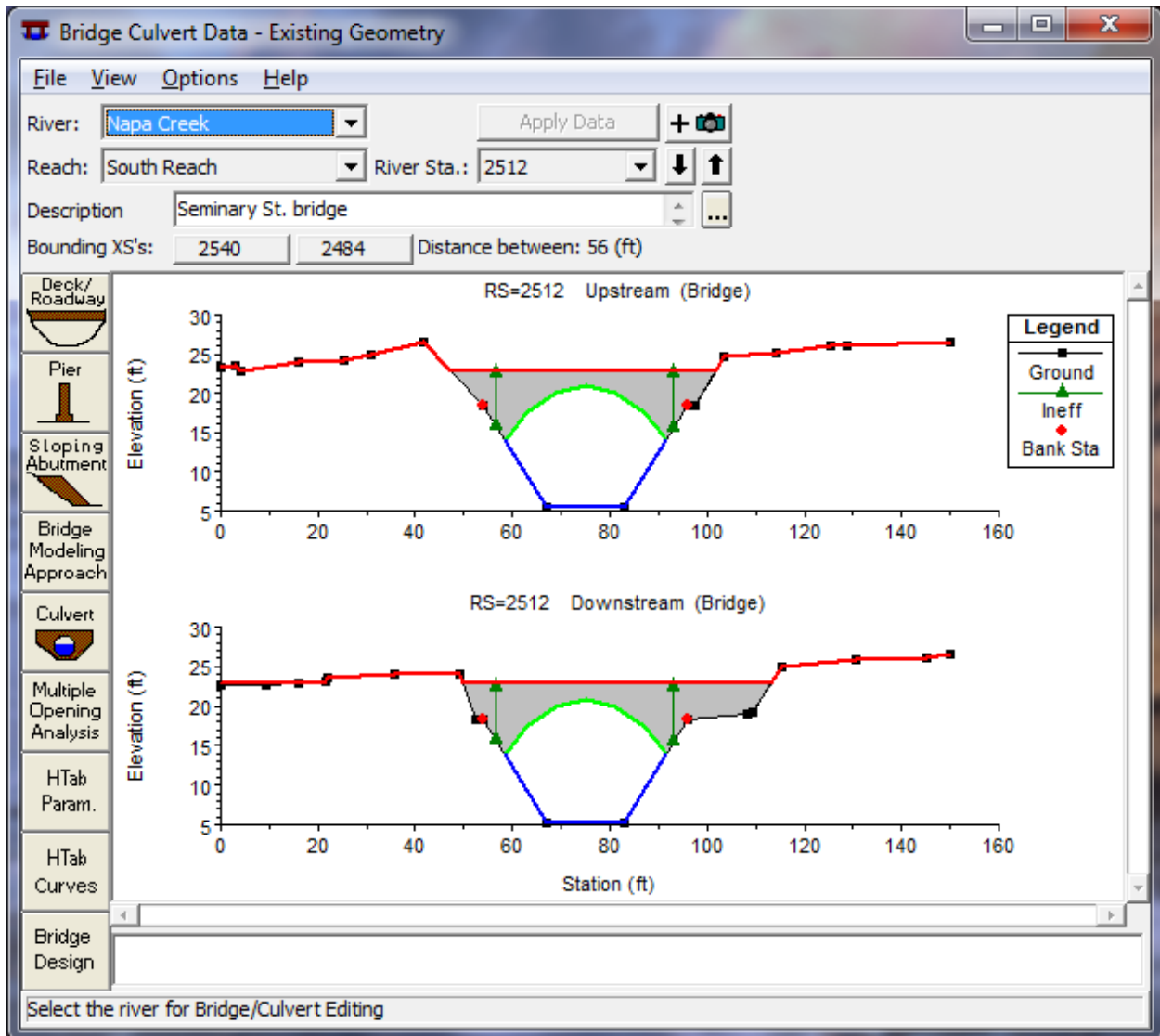

Figure 7-2: Seminary Street Bridge at River Station 2512

## Steady Flow Data

The next step was to develop the steady flow data file. To create this file, from the main program window **Edit** and then **Steady Flow Data** were selected. This activated the **Steady Flow Data Editor** as shown in Figure 7.3. One profile was selected to be analyzed for the reach "South Reach." The flow value of 4070 cfs, representing the one-percent chance flood, was entered at river station 3800 (the upstream river station) and a downstream known water surface elevation of 13 feet was entered by selecting the **Boundary Conditions** icon. Finally, the steady flow data were saved. To perform this, from the **Steady Flow Data Editor**, **File** and then **Save Flow Data As** were selected. The title "100 year flow" was entered and the **OK** button was selected. The editor was then closed.

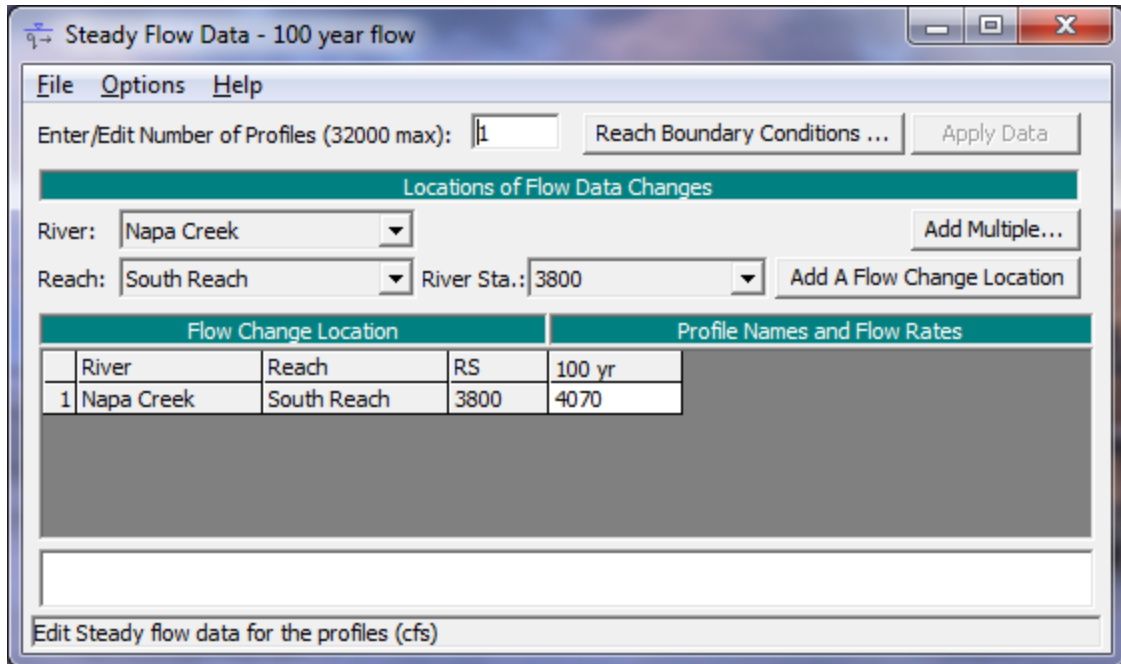

Figure 7-3: Steady Flow Data Editor

### Existing Conditions Plan

Once the geometric data and steady flow data were entered and saved, a plan that associated these two files was created. To perform this, from the main program window, **Run** and then **Steady Flow Analysis** were selected. This activated the **Steady Flow Analysis Window** as shown in Figure 7.4. Next, a **Short ID** was entered as "Existing." The geometry file "Existing Geometry" and the steady flow file "100 year flow" were selected by using the down arrows on the right side of the window (Note: At this point, only one geometry and one flow file existed and it was not necessary to use the arrows.). A subcritical analysis was chosen as the **Flow Regime** and then, **File** and **Save Plan As** were selected. The title "Existing Plan Data" was entered and the **OK** button selected. This created a plan that associated the existing conditions geometry file with the steady flow file. This plan had an extension ".P01" because it was the first plan created.

After the plan was saved, the **COMPUTE** button was selected to execute the program. During the execution, a run file with the extension ".R01" and an output file with the extension ".O01" were created. The extension number 01 for both the run and output files correspond with the plan with the same extension number.

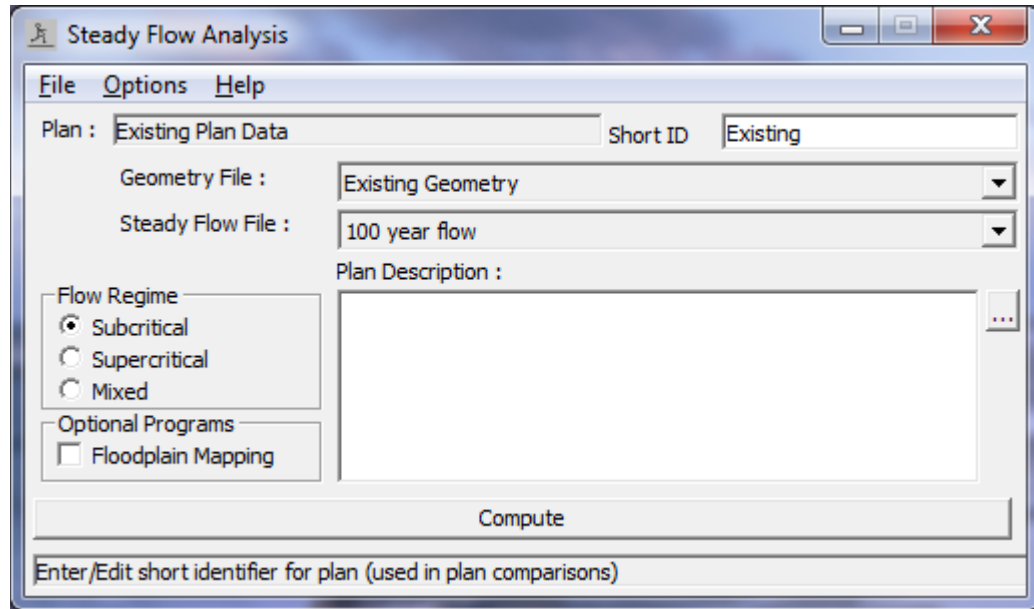

Figure 7-4: Steady Flow Analysis Window – Existing Conditions Plan

### Existing Conditions Output

The existing conditions output review will be limited to viewing the profile for the river reach. A more detailed analysis will be performed when comparing the existing and proposed model output in a subsequent section. To view the profile plot of the river reach, from the main program window select **View** and then **Water Surface Profiles**. This will display the profile as shown in Figure 7.5. The first part of the heading at the top of the profile is the name of the project: “Napa Cr. Bridge Project - Example 7.” The second part of the heading is the name of the plan: “Existing Plan Data.” Finally, the date that the output file was created also appears in the heading.

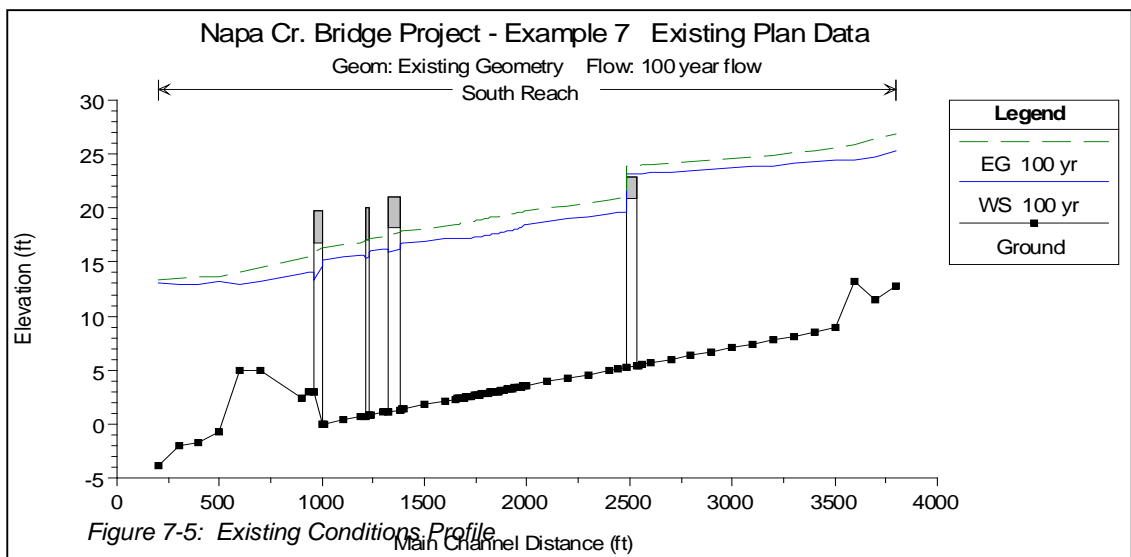

Figure 7-5: Existing Conditions Profile

The profile of the existing conditions analysis shows that the upstream bridge at river station 2512 was overtopped during the 100-year flow event. It was

proposed that a new bridge be installed to replace the existing bridge. The new bridge would be designed so that the 100-year flow event did not impact the bridge decking. To evaluate this proposed bridge replacement, the existing conditions geometry file was changed and a new plan was created. This procedure is outlined in the following sections.

## Proposed Conditions Analysis

For the proposed conditions, the bridge at river station 2512 will be replaced by a new bridge. To perform this, first the geometry file was changed to reflect the proposed conditions. Then, a new plan was created with the new proposed geometry file and the original steady flow file. This procedure is outlined below.

### Proposed Conditions Geometric Data

To change the geometry for the bridge at river station 2512, first the geometry file "Existing Geometry" was activated. Then, this geometry file was saved as a new geometry file. This was performed by selecting **File** and then **Save Geometry Data As** from the **Geometric Data Editor**. The title "Proposed Bridge" was entered and the **OK** button was chosen. This saved the geometry as a new geometry file. Then, all subsequent changes were made to the "Proposed Bridge" geometry file. This enabled the "Existing Geometry" file to remain unchanged.

With the "Proposed Bridge" geometry file, the **Geometric Data Editor** was activated and the **Bridge/Culvert** icon was selected. River station 2512 was chosen at the top of the editor and the **Deck/Roadway** icon was selected. The existing bridge data was deleted and the new information was entered. The new bridge decking was proposed to have a high cord elevation 1 foot higher than the existing bridge deck. This elevation was chosen as an initial estimate for the proposed bridge and can be altered after the output is reviewed.

After the decking was entered, the pier data was entered by selecting the Pier icon from the **Bridge/Culvert Data Editor**. Two piers were entered at stations 67 and 82. The pier editor was closed and the resulting bridge appeared as shown in Figure 7.6. Finally, the **Description** was modified to "Seminary St. Bridge - Proposed." The **Bridge Modeling Approach Editor** was not altered and the **Bridge/Culvert Data Editor** was closed.

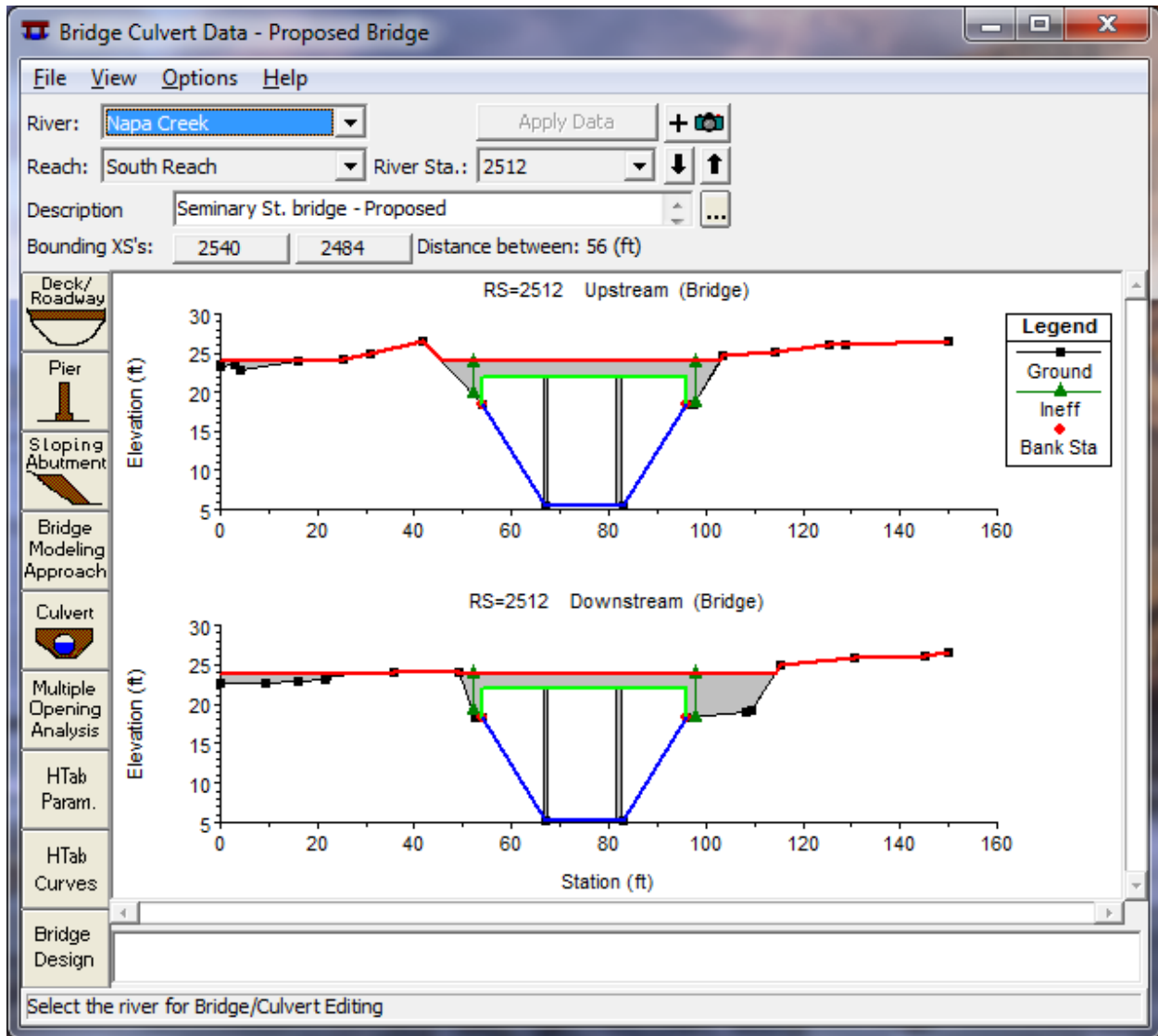

Figure 7-6: Seminar Street Bridge - Proposed

Since the bridge geometry changed at river station 2512, the expansion and contraction reach lengths were adjusted in the vicinity of the bridge. Then, the ineffective flow areas were reestablished at river stations 2484 and 2540. This concluded the changes to the geometric data, and the geometry file was saved by selecting **Save Geometry Data** from the **File** menu of the **Geometric Data Editor**.

### Steady Flow Data

The steady flow data for the analysis of the proposed bridge will be the same flow data used with the existing geometry. Therefore, there were no adjustments made to the steady flow data file "100 year flow."

### Proposed Conditions Plan

A new plan was created from the geometry file with the proposed bridge and the steady flow data file. To perform this, from the main program window **Run** and **Steady Flow Analysis** were selected. A **Short ID** was entered as "Proposed" in the upper right corner of the window. The geometry file "Proposed Bridge" and the steady flow file "100 year flow" were chosen by selecting the down arrows on the right side of the window. A subcritical analysis was chosen as the **Flow Regime**. Then, **File** and **Save Plan As** were selected. The title "Proposed Plan" was entered and the **OK** button was selected. This created a plan that associated the proposed conditions geometry file with the steady flow file. This plan had an extension ".P02" because it was the second plan created.

The **COMPUTE** button was selected to execute the program. During the execution, a run file with the extension ".R02" and an output file with the extension ".O02" were created. The extension number 02 for both the run and output files correspond with the plan number.

### Proposed Conditions Output

At this point, the user can activate the water surface profile plot for the proposed conditions, as performed for the existing conditions output. The next section will compare the results of the two plans and the two water surface profiles simultaneously.

## Comparison of Existing and Proposed Plans

To compare the output from the two plans, the user can view the results graphically and in tabular format. This comparison will describe the methods to view the output for both plans simultaneously.

### Profile Plot

To view the profile plot of both plans, from the main program window select **View** and then **Water Surface Profiles**. Then, select **Options** and **Plans**. This will activate the pop-up window shown in Figure 7.7. The plan selection window is divided into two parts: an option for comparing multiple geometries at the top, and a box containing all of the available plans to view output for. To select plans for viewing their output, simply check the box in front of each plan label. Additionally, the **Select All** and **Clear All** buttons can be used. For this example, both plans were selected by choosing the **Select All** button. Then, the **OK** button was chosen to exit the window. This resulted in the profile as shown in Figure 7.8. The option for comparing geometries allows the user to plot the output and geometric data for two plans simultaneously. Since the invert and channel geometry did not change between these two plans, there was no benefit to selecting this option.



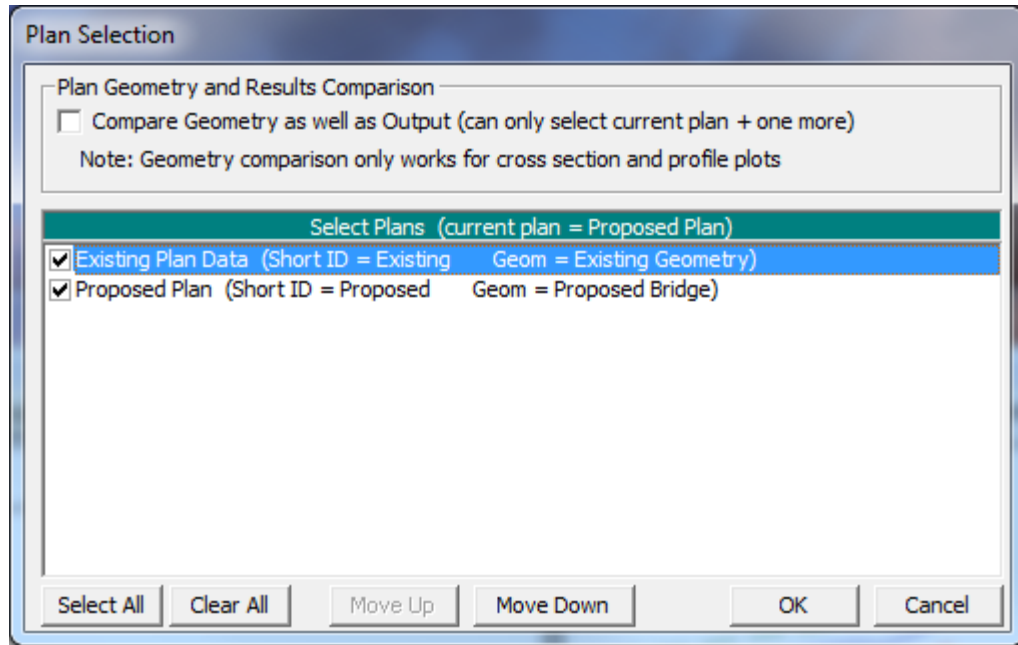

Figure 7-7: Plan Selection Box

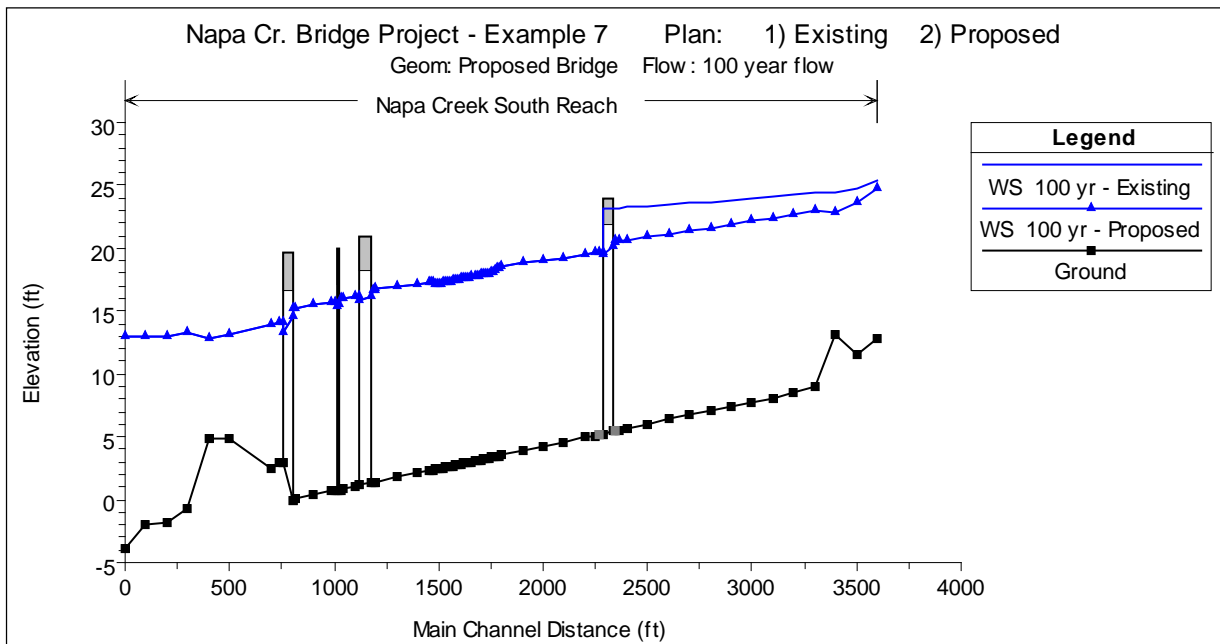

Figure 7-8: Profiles of Both Existing and Proposed Plans

Figure 7.8 shows the profile for both plans. The heading displays the information as discussed previously. The legend shows that there are two water surface profiles plotted in the figure. The first profile is labeled "WS 100 yr - Existing" and is a solid line. The label "WS 100 yr" refers to the label of the flow data for the first water surface profile, while the label "Existing" refers to the Plan **Short ID** that was entered in the **Steady Flow Analysis Window**. Therefore, this water surface is for the Existing Condition plan. Similarly, the label "WS 100 yr - Proposed" is the 100 yr water surface profile for the "Proposed" plan data.

Since both plans only had one flow entered, only one water-surface profile can be plotted for each plan. If other flow profiles had been computed, then the user could also select to plot those profiles.

It should be noted that since the profiles were plotted from the proposed conditions plan, the geometry that is displayed in Figure 7.8 is from the proposed conditions plan. In other words, the bridge at river station 2512 displays the geometry (elevation) of the proposed bridge. If this procedure had been performed from within the existing conditions plan, then the geometry of the profile would exhibit the existing conditions geometry. In either case, the water surface profiles for each plan are plotted as calculated for that plan. Finally, Figure 7.8 clearly shows the decrease in the upstream water surface due to the proposed bridge allowing the flow to pass completely under the bridge.

### Cross Section Plots

In a similar manner, the water surface for both plans can be viewed on the cross section plots. This is performed by selecting **View** and then **Cross-Sections** from the main program window. River station 2512 (upstream inside bridge) was then chosen and this displayed the cross section plot as shown in Figure 7.9. It should be noted that once the option was selected to display the profiles from both of the plans, this option will remain in effect globally until otherwise selected. This allows the user to only activate this feature once, instead of having to set the option for each table and plot that is requested. This option can be returned to the default of only viewing the current plan information when viewing any of the plots or tables.

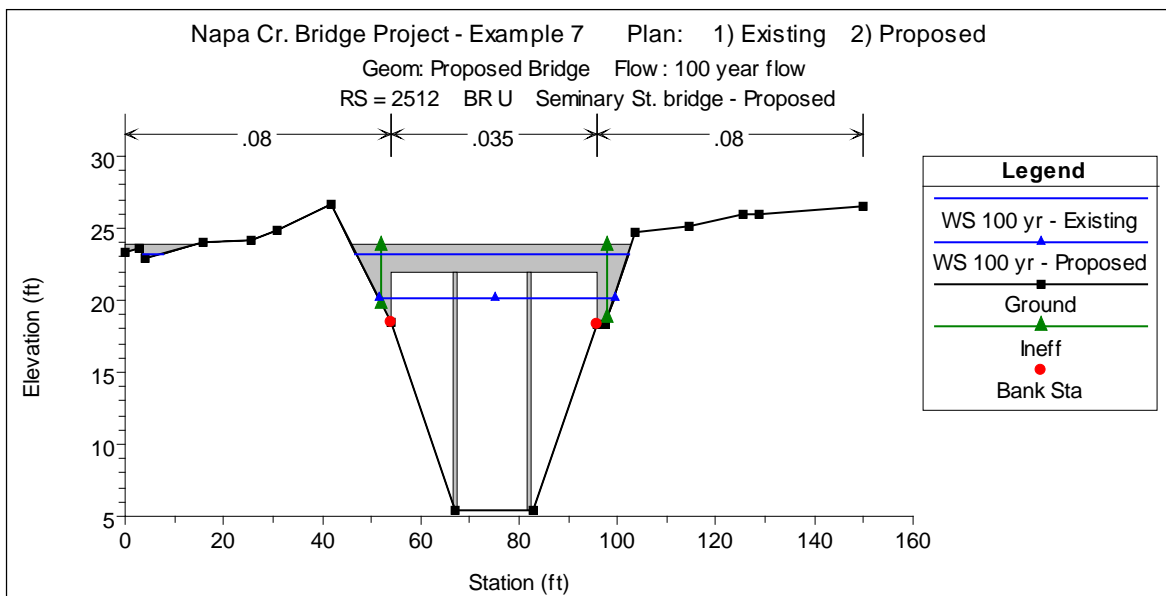

Figure 7-9: Cross Section 2512 for Proposed Plan showing both Existing and Proposed Profiles

Additionally, the program will revert back to only displaying the current plan information whenever a new plan or project is opened.

In reference to Figure 7.9, the headings and legend are as described previously. The cross section was selected from within the proposed geometry plan and therefore the bridge shown is the proposed bridge. The

first water surface is for the existing conditions plan and the second water surface is for the proposed conditions plan.

### Standard Table

In addition to graphical displays, the user can compare the output in tabular form. From the main program window, select **View** and then **Profile Summary Table**. By selecting **Standard Table 1**, the table as shown in Figure 7.10 will appear. The first two columns of the table in Figure 7.10 display the river reach and river station. The third column identifies which plan the data are from. The identifiers in this column are obtained from the **Short ID** entered in the **Steady Flow Data Editor**. The remaining portion of the table displays information for each plan such as total flow, energy gradeline elevation, water surface elevation, etc. By presenting the data in this format, the modeler can easily compare the output for each plan.

HEC-RAS River: Napa Creek Reach: South Reach Profile: 100 yr													
Reach	River Sta	Profile	Plan	Q Total	Min Ch El	W.S. Elev	Crit W.S.	E.G. Elev	E.G. Slope	Vel Chnl	Flow Area	Top Width	Froude # Chl
				(cfs)	(ft)	(ft)	(ft)	(ft)	(ft/ft)	(ft/s)	(sq ft)	(ft)	
South Reach	2564	100 yr	Existing	4070.00	5.53	23.22	15.68	23.98	0.001138	7.03	608.21	57.50	0.34
South Reach	2564	100 yr	Proposed	4070.00	5.53	20.60	15.65	21.79	0.002344	8.76	471.15	48.43	0.46
South Reach	2549,*	100 yr	Proposed	4070.00	5.49	20.57	15.60	21.76	0.002335	8.75	472.49	48.69	0.46
South Reach	2540	100 yr	Existing	4070.00	5.45	23.20	15.60	23.95	0.001117	6.99	613.55	59.37	0.33
South Reach	2540	100 yr	Proposed	4070.00	5.45	20.55	15.60	21.73	0.002312	8.72	472.84	48.89	0.46
South Reach	2512			Bridge									
South Reach	2484	100 yr	Existing	4070.00	5.26	19.64	15.42	21.10	0.002671	9.69	419.99	58.26	0.51
South Reach	2484	100 yr	Proposed	4070.00	5.26	19.73	15.43	21.07	0.002836	9.27	443.61	58.40	0.51
South Reach	2471*	100 yr	Proposed	4070.00	5.21	19.70	15.33	21.02	0.002807	9.24	446.48	50.21	0.50
South Reach	2446	100 yr	Existing	4070.00	5.10	19.65	15.23	20.95	0.002735	9.15	447.78	46.93	0.50
South Reach	2446	100 yr	Proposed	4070.00	5.10	19.65	15.23	20.95	0.002735	9.15	447.78	46.93	0.50

Total flow in cross section.

Figure 7-10: Standard Table 1 for Both Existing and Proposed Plans

As an additional note, if a river station only appears in one of the plans, then the table will only display the data for that plan. This occurs for river station 2549\* and 2471\*, which are only used in the proposed geometry plan. These river stations can be viewed by using the down arrows on the right side of the table.

### Bridge Only Table

In a similar fashion to the first standard table, the **Bridge Only Table** was activated from the **Std. Tables** pull down menu and is shown as Table 7.2. To insert this table into the text, **File**, and then **Copy to Clipboard** were selected. Then, the table was pasted into this document and appeared as shown in Table 7.2.

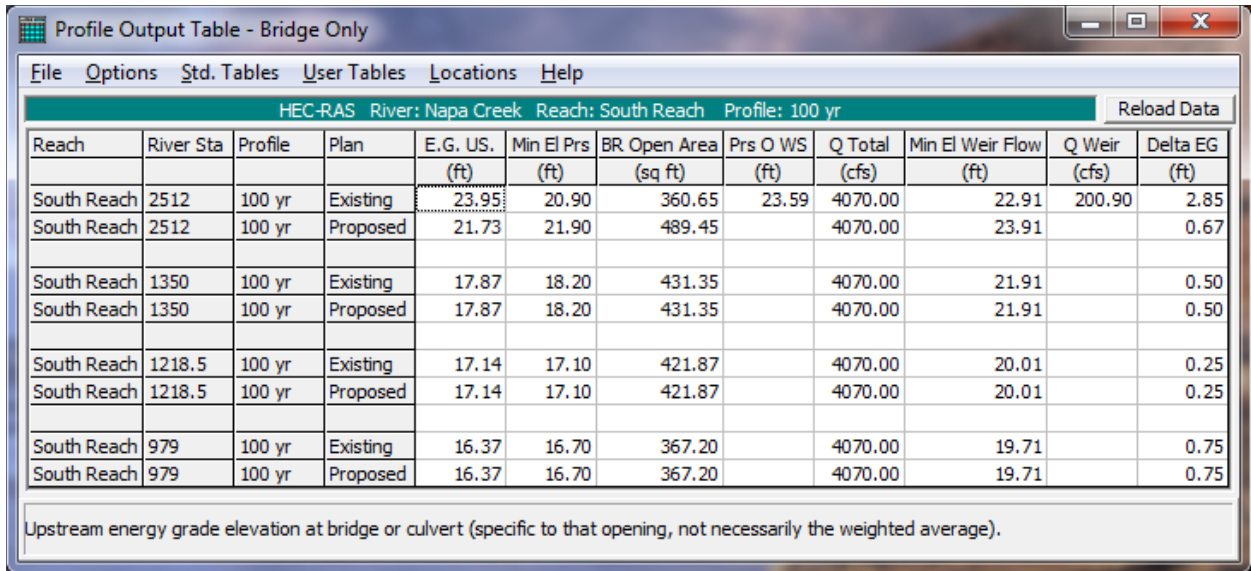

Reach	River Sta	Profile	Plan	E.G. US. (ft)	Min El Prs (ft)	BR Open Area (sq ft)	Prs O WS (ft)	Q Total (cfs)	Min El Weir Flow (ft)	Q Weir (cfs)	Delta EG (ft)
South Reach	2512	100 yr	Existing	23.95	20.90	360.65	23.59	4070.00	22.91	200.90	2.85
South Reach	2512	100 yr	Proposed	21.73	21.90	489.45		4070.00	23.91		0.67
South Reach	1350	100 yr	Existing	17.87	18.20	431.35		4070.00	21.91		0.50
South Reach	1350	100 yr	Proposed	17.87	18.20	431.35		4070.00	21.91		0.50
South Reach	1218.5	100 yr	Existing	17.14	17.10	421.87		4070.00	20.01		0.25
South Reach	1218.5	100 yr	Proposed	17.14	17.10	421.87		4070.00	20.01		0.25
South Reach	979	100 yr	Existing	16.37	16.70	367.20		4070.00	19.71		0.75
South Reach	979	100 yr	Proposed	16.37	16.70	367.20		4070.00	19.71		0.75

Upstream energy grade elevation at bridge or culvert (specific to that opening, not necessarily the weighted average).

Figure 7-11: Bridge Only Table for both Existing and Proposed Plans

As for the standard table, the river reach and river stations are shown in the first two columns and the **Short IDs** are used to identify the plans in the third column. This table shows that for the bridge at river station 2512, weir flow occurred for the existing conditions bridge but did not occur for the proposed bridge geometry plan. The data for the other three bridges in the table are the same for both plans since there was only a change in the geometry at the upstream bridge.

### X-Y-Z Perspective Plot

As a final view of the output, a 3D view of the river reach is shown in Figure 7.11. This plot was activated from the main program window by selecting **View** and then **X-Y-Z Perspective Plots**. Only a portion of the Napa Creek reach is shown in the figure for clarity. The figure displays the 3D plot from river station 3300 to river station 2200. This was performed by selecting the **Start** and **End** down arrows and selecting the appropriate river stations. The modeler can select various azimuth and rotation angles to obtain differing views of the river reach. The river stations on the plot are aligned according to the configuration as drawn on the **River System Schematic**.

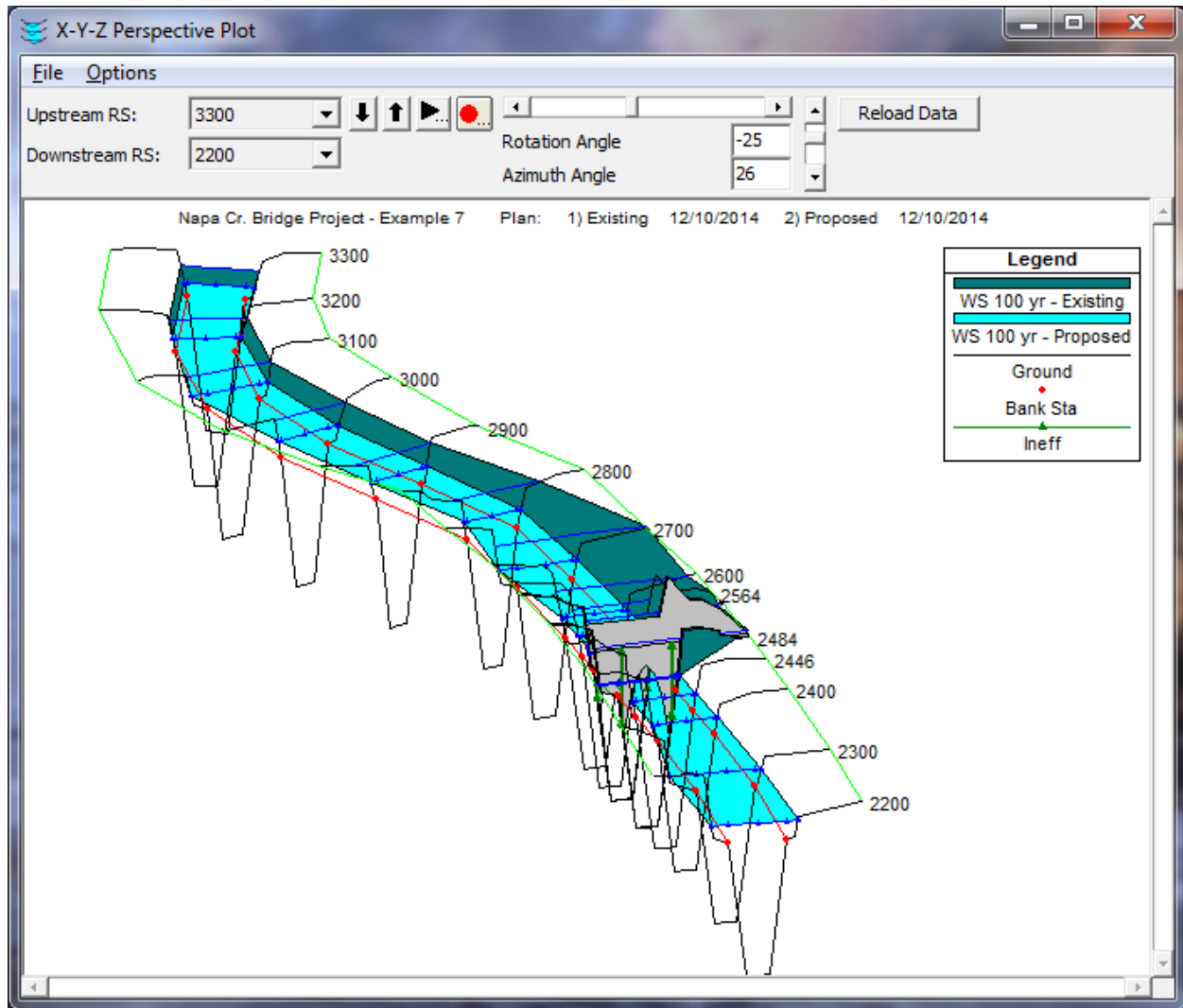

Figure 7-12: X-Y-Z Perspective Plot of a Portion of Napa Creek for Both Existing and Proposed Plans

## Summary

For Example 7, the concept of multiple plan analysis within a single project was discussed. There are several advantages to using a multiple plan analysis. One of these advantages is the use of a single flow data file for multiple geometry simulations. This reduces the need for identical flow files. Another advantage pertains to the analysis of the output. With multiple plans, the user can select to have the data from any number of plans displayed collectively. This allows for a proficient comparison of the plans.

For this example, the multiple plans were developed by altering the geometry of the river reach. Conversely, a multiple plan analysis could be composed of plans that relate changes of user-selected coefficients such as energy loss coefficients, Manning's  $n$  values, and entrance and exit loss coefficients. By understanding the concept of multiple plan analyses, the user can employ a more efficient procedure for analyzing a project.



## CHAPTER 8

# Looped Network

### Purpose

This example was performed to demonstrate the analysis of a river reach that contains a loop. The loop is caused by a split in the main channel that forms two streams which join back together.

The focus of this example is on the development of the looped network and the balancing of the flows through each branch of the loop. The stream junctions will be discussed briefly; however, a more detailed discussion of stream junctions can be found in example 10. **Note: Since this example was developed, we have added the ability to have the program optimize the flow split at junctions for you. Example application 15 shows how to use the split flow optimization routine.**

To review the data files for this example, from the main HEC-RAS window, select **File** and then **Open Project**. Go to the directory in which you have installed the HEC-RAS example data sets. From the "Applications Guide\Chapter 8 – Looped Network" subdirectory, select the project labeled "Looped Network - Example 8." This will open the project and activate the following files:

Plan:	"Looped Plan"
Geometry:	"Looped Geometry"
Flow:	"10, 50, and 100 year flow events"

### Geometric Data

The geometric data for this example consists of the river system schematic, the cross section data, and the stream junction data. Each of these components are discussed below.

#### River System Schematic

To view the river system schematic, from the main program window select **Edit** and then **Geometric Data**. This will activate the **Geometric Data Editor** and display the river system schematic as shown in Figure 8.1. The schematic shows the layout of the two rivers. Spruce Creek is broken into three river reaches: Upper Spruce Creek, Middle Spruce Creek, Lower Spruce Creek. Bear Run is left as a single river reach. The flow in Upper Spruce Creek splits at Tusseyville to form Bear Run and Middle Spruce Creek. Bear Run is approximately 1500 feet in length and Middle Spruce Creek is approximately 1000 feet long. These two streams then join at Coburn to form Lower Spruce Creek.

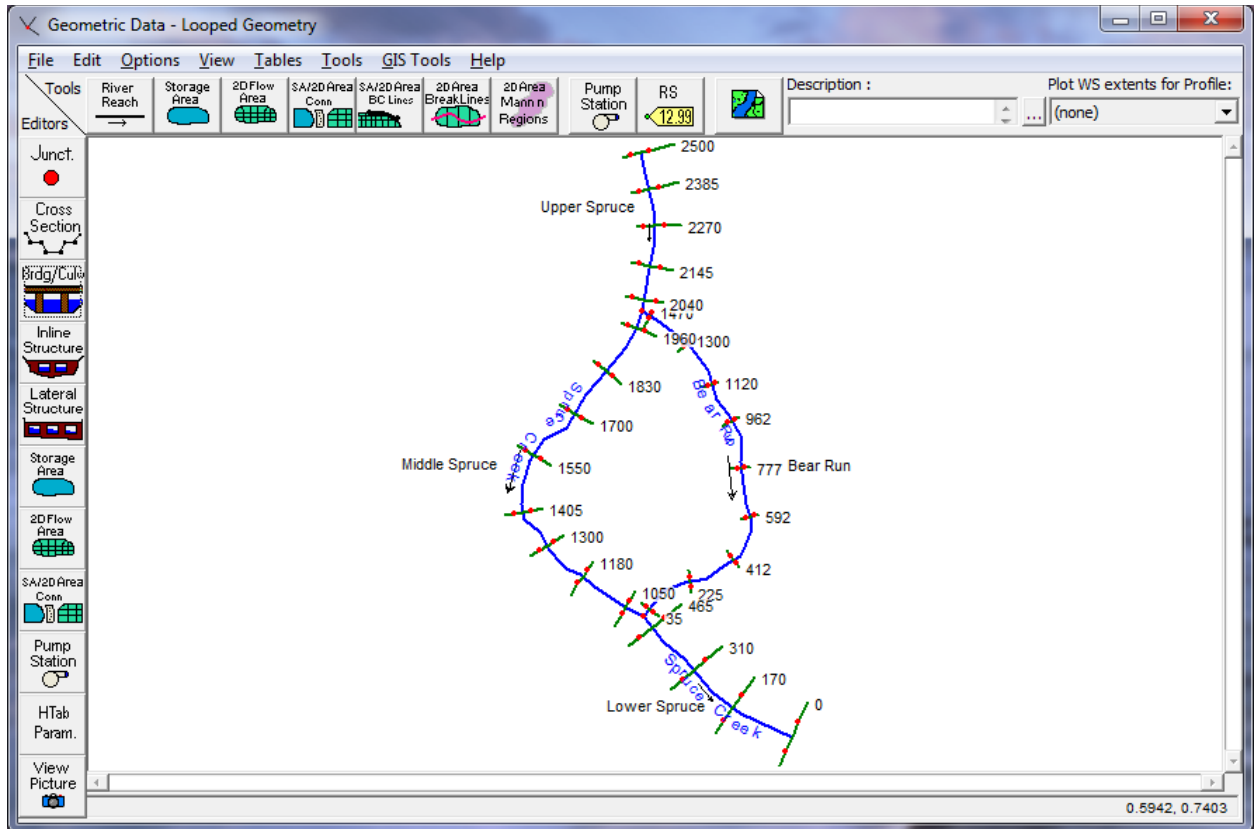

Figure 8-1: River System Schematic for Spruce Creek and Bear Run

## Cross Section Data

After the river reaches were sketched to form the river system schematic, the cross section data were entered. The data were entered by selecting the **Cross Section** icon from the **Geometric Data Editor**. For each cross section, the geometric data consisted of the: X-Y coordinates, downstream reach lengths, Manning's n values, main channel bank stations, the contraction and expansion coefficients, and, if applicable, left or right levees.

After all of the geometric data were entered, **File** and then **Save Geometry Data As** were selected from the **Geometric Data Editor**. The title "Looped Geometry" was entered and the **OK** button selected. This was the only geometry file for this example.

## Stream Junction Data

The final geometric component was the data for the stream junction. These data were entered by selecting the **Junction** icon on the **Geometric Data Editor**. This caused the **Junction Data Editor** to appear as shown in Figure 8.2. First, the data for the junction at Tusseyville was entered by selecting the appropriate *Junction Name* at the top of the editor. Then a *Description* was entered as "Spruce Creek Split."



**Junction Data - Looped Geometry**

Junction Name:

Description:

Length across Junction	Junction Length (ft)	Tributary Angle (Deg)
From: Spruce Creek - Upper Spruce		
To: Spruce Creek - Middle Spruce	80	
To: Bear Run - Bear Run	70	

Steady Flow Computation Mode  
 Energy  
 Momentum  
 Add Friction  
 Add Weight

Unsteady Flow Computation Mode  
 Force Equal WS Elevations  
 Energy Balance Method

Select Junction to Edit

Figure 8-2: Junction Data Editor for Tusseyville Junction

The next piece of information required was the *Length Across Junction*. These are the distances from the downstream river station of Upper Spruce to the upstream river stations of Middle Spruce and Bear Run. In general, the cross sections that bound a junction should be placed as close to the junction as possible. This will allow for a more accurate calculation of the energy losses across the junction. These values were entered as 80 and 70 feet, for the distances to Middle Spruce and Bear Run, respectively.

The last item in the junction editor is the computation mode. Either the *Energy* or the *Momentum* method must be selected. The energy method (the default method) uses a standard step procedure to determine the water surface across the junction. The momentum method takes into account the angle of the tributaries to evaluate the forces associated with the tributary flows. For this example, the flow velocities were low and the influence of the tributary angle was considered insignificant. Therefore, the energy method was selected for the analysis. For a further discussion on stream junctions, the user is referred to example 10 and to chapter 4 of the **Hydraulic Reference Manual**.

After the data were entered for the Tusseyville Junction, the **Apply Data** button was selected. The down arrow adjacent to the *Junction Name* was depressed to activate the second junction at Coburn. At this junction, the description "Confluence of Bear Run and Middle Spruce" was entered. Next, a length of 70 feet was entered from Bear Run to Lower Spruce and 85 feet for the distance from Middle Spruce to Lower Spruce. Again, the energy method was selected and the **Apply Data** button was chosen before closing the junction editor.

## Steady Flow Data

The steady flow data were entered next. These data consisted of the profile data and the boundary conditions. Each of these items is discussed as follows.

### Profile Data

To enter the steady flow data, the **Steady Flow Data Editor** was activated from the main program window by selecting **Edit** and then **Steady Flow Data**. This opened the editor as shown in Figure 8.3. On the first line of the editor, the number of profiles was chosen to be 3. These profiles will represent the 10, 50, and 100 - year flow events. When the number of profiles is entered, the table expands to provide a column for each profile.

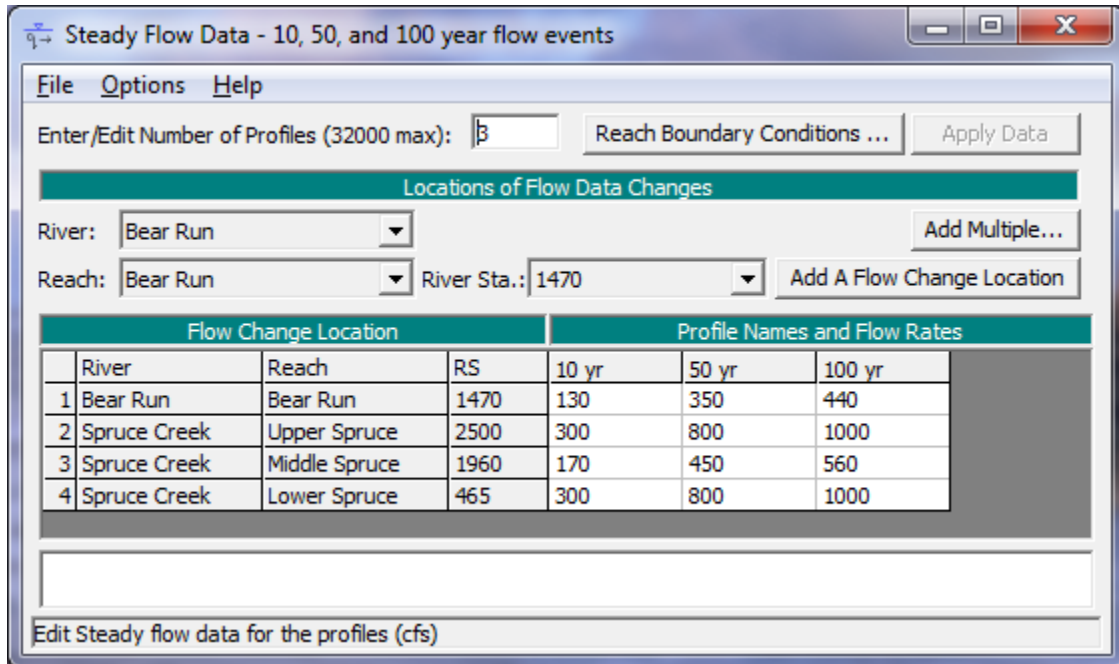

Figure 8-3: Steady Flow Data Editor – Looped Plan – 1st Flow Distribution

To enter the flow data, a flow value must be entered at the upstream end of each reach. The program will consider the flow rate to be constant throughout the reach unless a change in flow location is entered. For this example, the flow will be constant throughout each reach. The three profiles will be for flow values of 300, 800, and 1000 cfs. These values were entered as the flow rates for Upper Spruce and Lower Spruce.

For the flow rates through Middle Spruce and Bear Run, the user must estimate the amount of flow for each reach. Then, after the analysis, the user must compare the energy values at the upstream ends of Middle Spruce and Bear Run. If the energy values differ by a significant amount, then the flow rates through the two reaches must be redistributed and a second analysis performed. This process will continue until the upstream energies are within a reasonable tolerance. This procedure implies that the upstream cross sections of Middle Spruce and Bear Run are located close to the junction. Therefore, the energy value at these two locations should be approximately equal.

For this first attempt at a flow distribution, the values of 170 and 130 cfs were entered for the first profile for Middle Spruce and Bear Run, respectively. Similarly, flow values of 450 and 350 were entered for the second profile and 560 and 440 for the third profile. After the analysis, the upstream energies for each profile were compared to determine if the flow distribution was appropriate. This will be discussed in a subsequent section.

## Boundary Conditions

After the flow data were entered, the boundary conditions were established. This was performed by selecting the **Boundary Conditions** icon from the top of the **Steady Flow Data Editor**. This resulted in the display as shown in Figure 8.4. As shown in Figure 8.4, the boundary conditions table will automatically contain any internal boundary conditions such as stream junctions. The user is required to enter the external boundary conditions. For this example, a subcritical flow analysis was performed; therefore, the external boundary condition at the downstream end of Lower Spruce was specified. **Normal Depth** was chosen with a slope of 0.0004 ft/ft. After the boundary condition was entered, the editor was closed and the flow data was saved as "10, 50, and 100 year flow events."

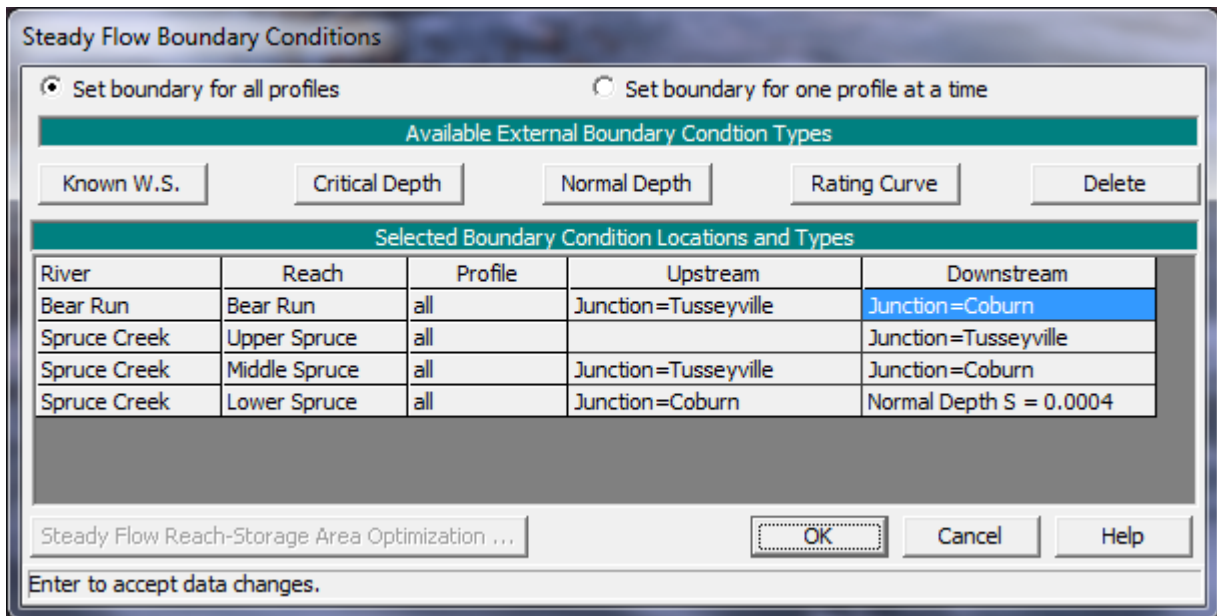

Figure 8-4: Steady Flow Boundary Conditions for Looped Network

## Steady Flow Analysis

After the geometric and flow data were entered, the files were then saved as a plan. This was performed by selecting **Run** and then **Steady Flow Analysis** from the main program window. This activated the **Steady Flow Analysis Window** as shown in Figure 8.5. In the steady flow window, first the **Short ID** of "Loop" was entered. Next, the geometry file "Looped Geometry" and the steady flow data file "10, 50, and 100 year flow events" were selected by depressing the down arrows on the right side of the window.

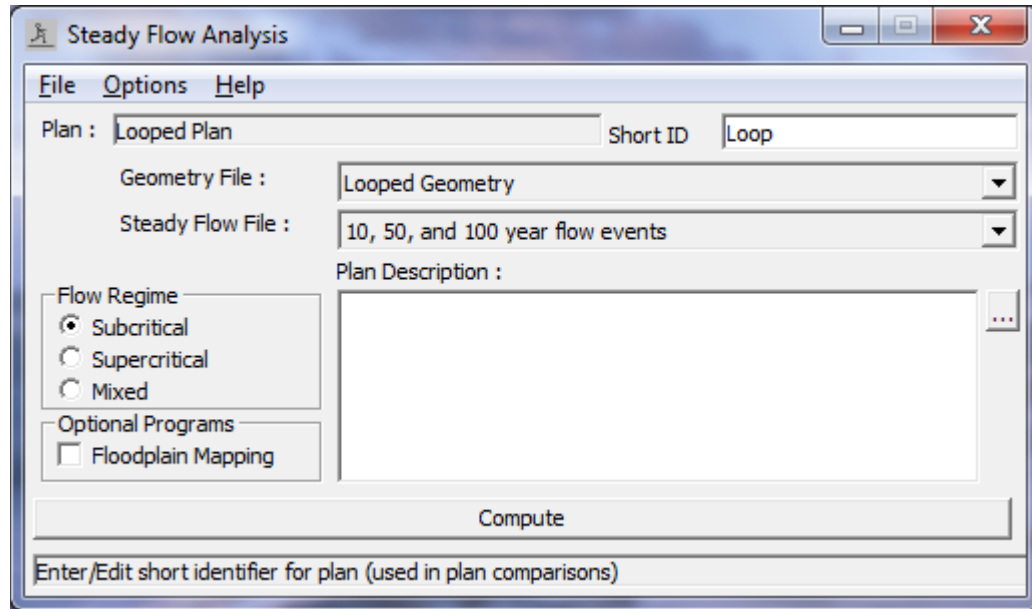

Figure 8-5: Steady Flow Analysis Window

(Note: Since there was only 1 geometry file and only 1 flow file, this was not necessary.) Then, **File** and **Save Plan As** were selected and the title “Looped Plan” was entered. The **OK** button was selected and the plan title appeared near the top of the steady flow window. Finally, the **Flow Regime** was selected as subcritical and the **COMPUTE** button was selected.

## Analysis of Results for Initial Flow Distribution

The user can review the results of the analysis both graphically and in tabular format. For this example, this discussion will initially be concerned with the flow distribution as selected for Bear Run and Middle Spruce. To determine the adequacy of the previously chosen flow distribution, the energy gradeline elevations at the upstream end of Bear Run and Middle Spruce will be compared. To determine the calculated energy values, the **Junction Table** was reviewed and a portion of the table is shown in Figure 8.6. This table was activated from the main program window by selecting **View**, **Profile Summary Table**, **Std. Tables**, and then **JunctionTable 1**.

The rows in the table in Figure 8.6 are divided into groups of three, one row for each of the three profiles. The first column of the table displays the river reach, the second column displays the river station, and the third column lists the water surface elevation for the particular river station. As can be seen in Figure 8.6, for the river reach of Middle Spruce at the river station 1960 (the upstream station), the flow rates were 170, 450, and 560 cfs, and the energy gradeline elevations were 23.37, 25.19, and 25.67 feet for the three flow profiles. The energy gradeline elevations for the upstream river station of Bear Run (river station 1470) were 23.10, 24.96, and 25.52 feet. By comparing these values, it can be seen that the energy gradelines differ by 0.27, 0.23, and 0.15 feet for the three profiles, respectively.

Since the upstream river stations on Middle Spruce and Bear Run were located close to the stream junction, the energy gradeline elevations for these two river stations should be approximately equal. Therefore, the flow rates

for Middle Spruce and Bear Run were redistributed and a subsequent analysis was performed. This is discussed in the next section.

Reach	River Sta	Profile	W.S. Elev (ft)	E.G. Elev (ft)	Q Total (cfs)
Upper Spruce	2040	10 yr	23.40	23.44	300.00
Upper Spruce	2040	50 yr	25.17	25.27	800.00
Upper Spruce	2040	100 yr	25.62	25.76	1000.00
Junction: Tusseyville					
Middle Spruce	1960	10 yr	23.28	23.37	170.00
Middle Spruce	1960	50 yr	25.02	25.19	450.00
Middle Spruce	1960	100 yr	25.50	25.67	560.00
Bear Run	1470	10 yr	23.03	23.10	130.00
Bear Run	1470	50 yr	24.84	24.96	350.00
Bear Run	1470	100 yr	25.38	25.52	440.00

Calculated water surface from energy equation.

Figure 8-6: Junction Table for First Estimate of Flow Distribution

## Steady Flow Analysis with New Flow Distribution

After reviewing the energy gradeline values at the upstream river stations for Middle Spruce and Bear Run, the flow rates for these river reaches were redistributed. Since the energy values for Bear Run were lower than that of Middle Spruce for all three of the profiles, a greater portion of the total flow was apportioned to Bear Run for all of the profiles. To perform this, the **Steady Flow Data Editor** was activated and the flow values were adjusted. Then a subsequent analysis was performed and the energy values compared. This procedure was continued until the energy values were within a reasonable tolerance. Table 8.1 shows the final flow distribution and the resulting energy gradeline values for the upstream river stations of Middle Spruce and Bear Run.

Additionally, the table shows the energy gradeline values for the downstream river station of Upper Spruce Creek. These values should be greater than the energy values for the upstream river stations of Middle Spruce and Bear Run. The final energy values for Middle Spruce and Bear Run are within a reasonable tolerance for each profile. Therefore, the flow distribution as shown in Table 8.1 was considered as a reasonable estimate of the flow rates through each river reach.

Table 8-1: Final Flow Distribution for Looped Plan

Reach	River Station	Profile	Flow Rate (cfs)	Energy Gradeline Elevation (ft)
Upper Spruce	2040	1	300	23.29
Middle Spruce	1960	1	154	23.25
Bear Run	1470	1	146	23.24
Upper Spruce	2040	2	800	25.15
Middle Spruce	1960	2	420	25.08
Bear Run	1470	2	380	25.08
Upper Spruce	2040	3	1000	25.67
Middle Spruce	1960	3	535	25.60
Bear Run	1470	3	465	25.60

## Analysis of Results for Final Flow Distribution

For an additional review of the flow distribution for the looped plan, the profile plot is shown in Figure 8.7. To activate the profile plot, from the main program window select **View** and then **Water Surface Profiles**. For this plot, the reaches of Upper Spruce, Middle Spruce, and Lower Spruce Creek were selected. This represents the flow along the right side of the river schematic.

Similarly, the flow along the left edge of the river schematic can be viewed by selecting the river reach Bear Creek instead of Middle Spruce. This is performed by selecting **Options, Reaches**, and then the appropriate river reach.

## Summary

As a summary for this example, a river system that contained a loop was analyzed. The flow rates for the branches of the loop were initially estimated and, after an initial analysis, the upstream energy values for each branch were compared. Since the initial energy values were not within a reasonable tolerance, the flow rates through each branch were redistributed and a subsequent analysis performed. This procedure was continued until the upstream energy values for the two branches were within a reasonable tolerance. By performing the flow distribution and energy comparison in this manner, it was necessary that the cross sections around the junction were spaced close together.

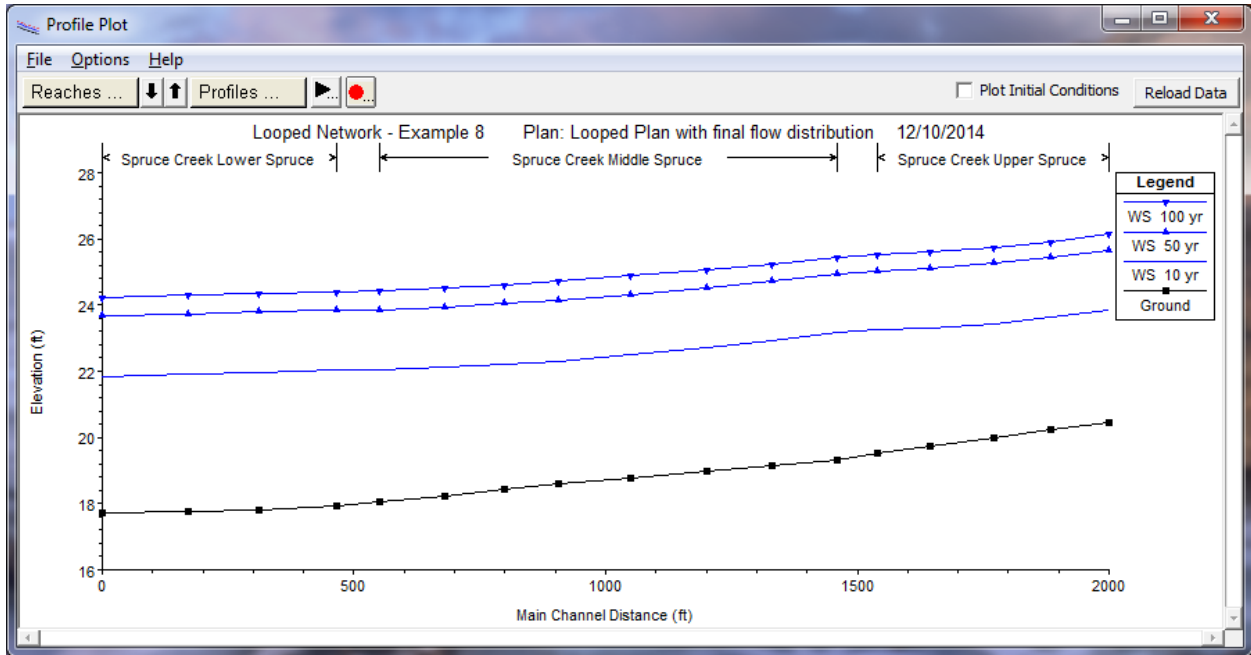

Figure 8-7: Profile Plot for Looped Network





## CHAPTER 9

# Mixed Flow Analysis

## Purpose

This example demonstrates the analysis of a river reach that contains both subcritical and supercritical flow. This mixed flow problem is caused by a bridge structure that constricts the flow enough to force it to pass through critical depth, creating a backwater effect and causing subcritical flow immediately upstream from the bridge.

The discussion of this example will focus on the analysis of the mixed flow regime. Additionally, the bridge structure was analyzed using both the energy method and the pressure flow method. The results of these methods are then compared. For a more detailed discussion on bridge analyses, the user is referred to chapter 6 of the **User's Manual** and to chapter 5 of the **Hydraulic Reference Manual**.

To review the data files for this example, from the main HEC-RAS window, select **File** and then **Open Project**. Go to the directory in which you have installed the HEC-RAS example data sets. From the "Applications Guide\Chapter 9 – Mixed Flow Analysis" subdirectory, select the project labeled "Mixed Flow - Example 9." This will open the project and activate the following files:

Plan:	"Putah Creek Bridge"
Geometry:	"Base Geometry Data - Energy"
Flow:	"100 Year Discharge"

## Geometric Data

The geometric data for this example consists of the river system schematic, the cross section data, the locations of the cross sections, and the bridge data. Each of these components is discussed below.

### River System Schematic

To view the river system schematic, from the main program window select Edit and then Geometric Data. This will activate the Geometric Data Editor and display the schematic, as shown in Figure 9.1. The schematic shows the layout of a section of Putah Creek, which consists of 20 cross sections. Cross section 12 is the upstream river station and cross section 1 is the downstream river station. Additionally, a bridge was located at river station 7 and will be discussed in a subsequent section.

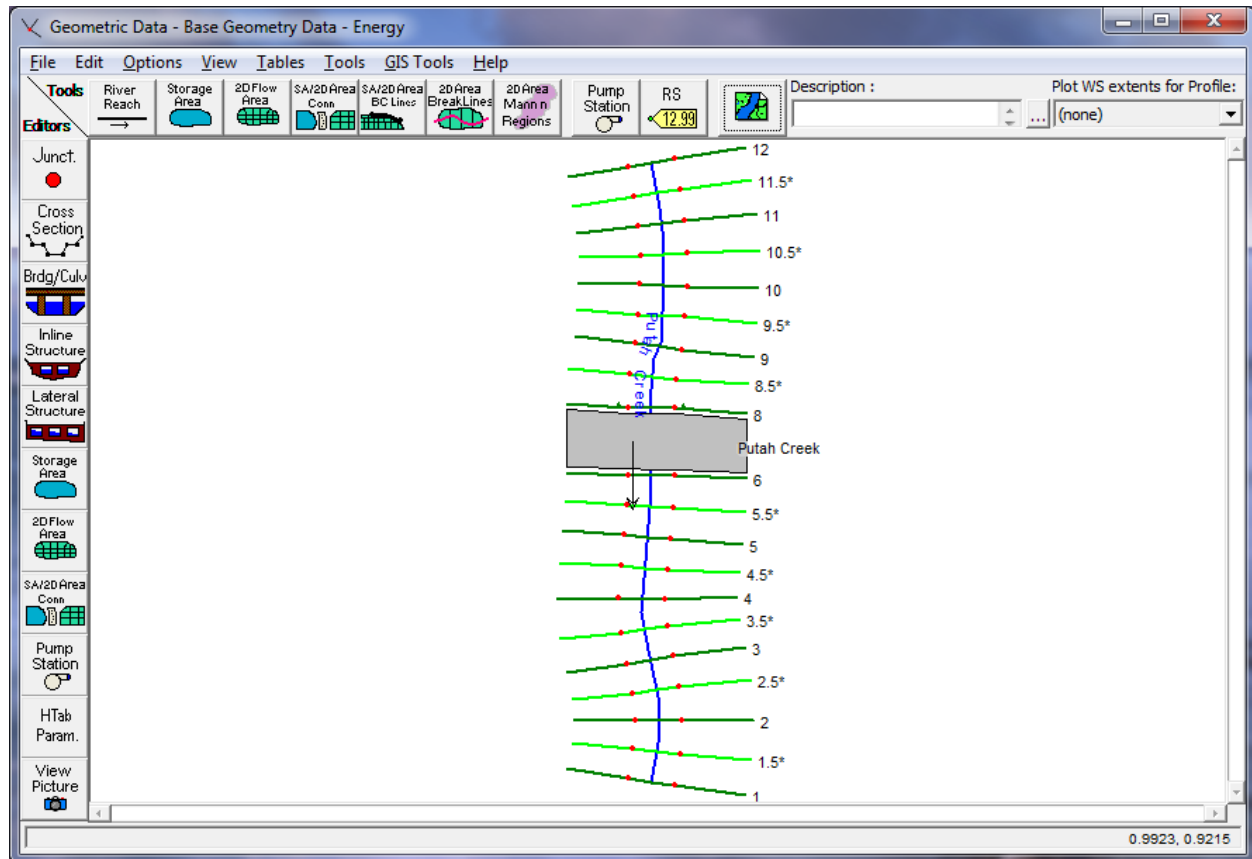

Figure 9-1: Putah Creek River System Schematic

## Cross Section Data

The data for each cross section is comprised of: a description, the X-Y coordinates, downstream reach lengths, Manning's n values, main channel bank stations, and the expansion and contraction coefficients. The data used for this example can be viewed by selecting the Cross Section icon on the Geometric Data Editor (Figure 9.1). It should be noted that the whole number cross sections were obtained from field data and the cross sections with an \* were interpolated. This will be discussed in the following section.

## Location of the Cross Sections

The location of the cross sections in relation to the bridge is crucial for the accurate calculation of the expansion and contraction losses. The bridge routine utilizes four cross sections, two upstream and two downstream from the structure, to determine the energy losses through the structure. The modeler is referred to chapter 6 of the **User's Manual** and chapter 5 of the **Hydraulic Reference Manual** for additional discussion on the location of cross sections and for modeling bridges.

For this example, the flow used for this analysis will remain in the main channel during the event. Additionally, there is only one pier for the bridge and the cross sections in the vicinity of the bridge do not reflect major

changes in geometry. Therefore, there is no major expansion or contraction losses occurring in the vicinity of the bridge.

Since the flow in the main channel is supercritical, the cross sections were placed close together to more accurately calculate the energy losses along the channel. The cross-section data from the field survey were 100 feet apart. These data were entered and then additional cross sections were interpolated at 50 feet intervals. This was performed from within the **Geometric Data Editor** by selecting **Tools, XS Interpolation**, and then **Within a Reach**. This activated the **XS Interpolation by Reach Window** as shown in Figure 9.2.

Figure 9-2: Cross Section Interpolation by Reach Window

To perform the interpolation, the reach of Putah Creek and the starting and ending river stations of 12 and 1 were selected as shown in Figure 9.2. Then, a maximum distance of 50 feet was entered and the Interpolate XS's button was selected. This created the interpolated cross sections along the entire river reach. After the interpolation, each interpolated cross section was reviewed to determine the adequacy of the interpolation. For additional discussion on cross section interpolation, the user is referred to chapter 6 of the User's Manual and to chapter 4 of the Hydraulic Reference Manual.

As a final review of the cross section locations, from the **Geometric Data Editor** select **Tables** and then **Reach Lengths**. This will activate the **Reach Lengths Table** as shown in Figure 9.3. As can be seen in the table, the final channel reach lengths are 50 feet for each cross section, except through the bridge.

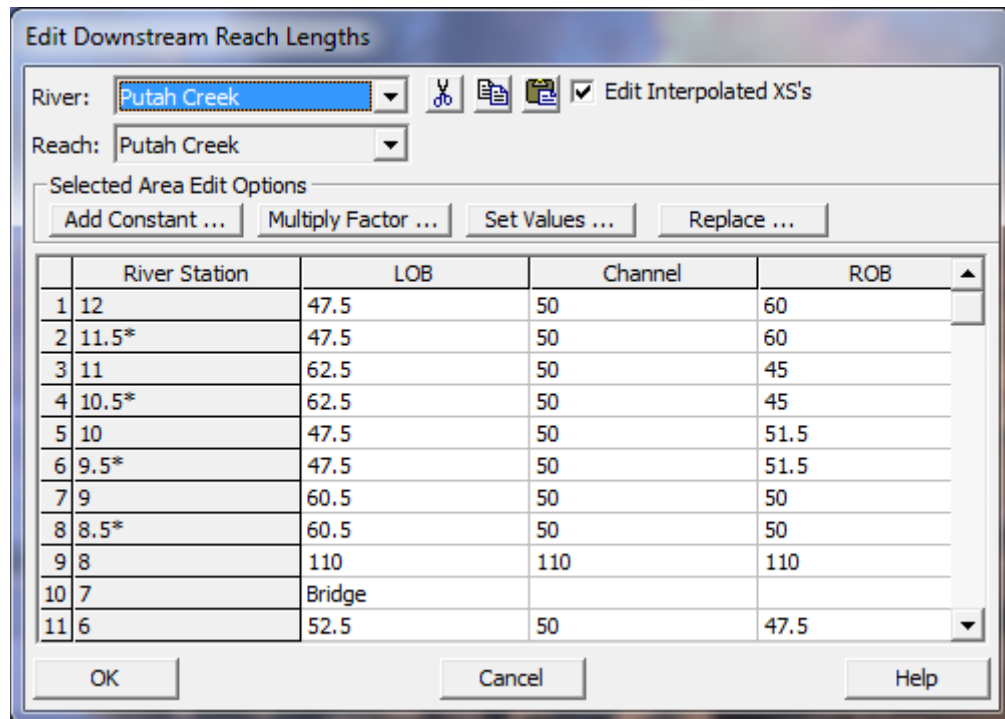

Figure 9-3 Reach Lengths Table for Putah Creek

## Bridge Data

To enter the bridge data for this example, first the deck/roadway data, then the pier data, and finally the bridge modeling approach data were entered. These components are described in the following sections.

**Deck/Roadway Data.** From the **Geometric Data Editor**, select the **Bridge/Culvert** icon. This will activate the **Bridge/Culvert Data Window**. Then select the **Deck/Roadway** icon on the left side of the window. This will activate the **Deck/Roadway Data Editor** as shown in Figure 9.4.

As shown in the Figure 9.4, the first item on the top row of the editor is the distance from the river station immediately upstream of the bridge (river station 8) to the upstream side of the bridge. For this example, this distance was set at 10 feet. The next item is the width of the deck/roadway and this distance was 90 feet. The program will then add the 10 feet and the 90 feet to obtain 100 feet as the distance from the river station 8 to the downstream side of the bridge. From the **Reach Lengths Table**, it can be seen that the distance from river station 8 to river station 6 was 110 feet. Therefore, the program will allow for 10 feet of distance from the downstream side of the bridge to river station 6 (the river station located immediately downstream of the bridge). The last item on the top row of the editor is the weir coefficient, which was set at 2.9.

Distance	Width	Weir Coef
10	90	2.9

Upstream			Downstream			
	Station	high chord	low chord	Station	high chord	low chord
1	0.	1285.	1282.	0.	1285.	1282.
2	292.	1285.	1282.	292.	1285.	1282.
3						
4						
5						
6						
7						
8						

U.S Embankment SS: 2      D.S Embankment SS: 2

Weir Data  
 Max Submergence: 0.95      Min Weir Flow El:

Weir Crest Shape  
 Broad Crested  
 Ogee

OK      Cancel

Enter distance between upstream cross section and deck/roadway. (ft)

Figure 9-4: Deck/Roadway Data Editor

The central portion of the editor consists of the station and elevation data for the low and high chords of the deck/roadway. These values were entered as shown. Finally, the bottom portion of the editor consists of the data entry for the weir flow calculations. For this example, weir flow did not occur and this data will not be emphasized. For additional discussion on the deck/roadway data, the user is referred to example 2 for bridges and to example 3 for culverts. The **OK** button was then selected to exit the editor.

**Pier Data.** To enter the pier data, the **Pier** icon was selected from the **Bridge/Culvert Data Editor**. This activated the **Pier Data Editor**. For this example, the bridge geometry consisted of only one pier located at a centerline station of 150 and a width of 8 feet. This data was entered and then the editor was closed. This concluded the input of the bridge geometry and the bridge appeared in the **Bridge/Culvert Data Editor** as shown in Figure 9.5.

As a final note for the bridge geometry, there were no ineffective flow areas defined for the analysis. This was due to the fact that the flow for the analysis remained in the main channel and the bridge geometry did not create any appreciable ineffective flow areas. This will become more apparent during the review of the output.

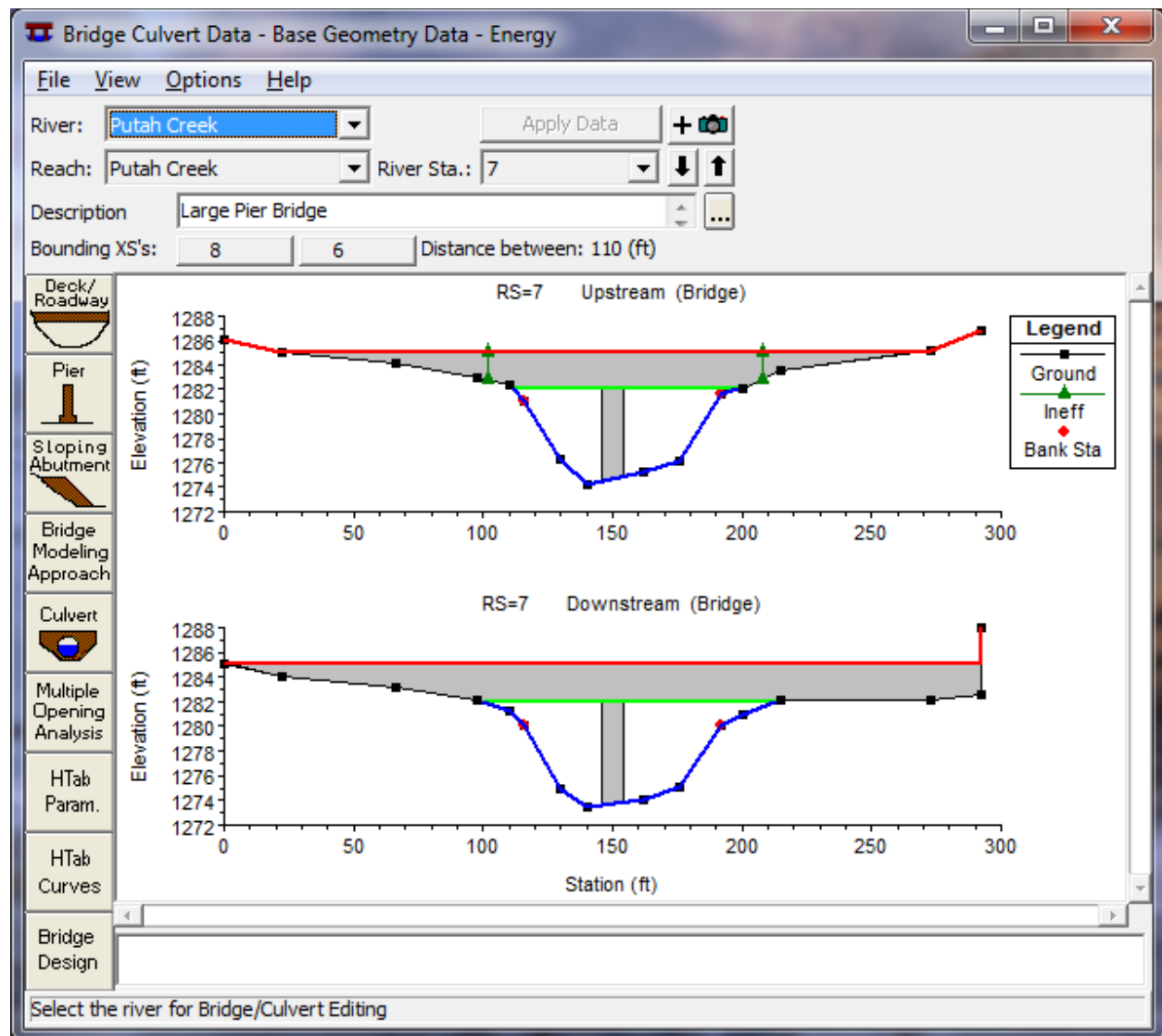

Figure 9-5: Bridge/Culvert Data Editor

**Bridge Modeling Approach.** The final component of the geometric data is the entering of the coefficients for the bridge analysis. This was performed by selecting the **Bridge Modeling Approach** icon on the **Bridge/Culvert Data Editor**. This activated the **Bridge Modeling Approach Editor** as shown in Figure 9.6.

The first selection is the low flow computation methods. For this example, the energy and momentum methods were selected. Then, the *Highest Energy Answer* field was selected. This will inform the program to use the greater answer of the energy and the momentum methods for the final solution of the low flow analysis. The next selection was the method for the high flow analysis. For this simulation, the energy method was selected. (A subsequent analysis was performed with the pressure/weir method and will be discussed later.)

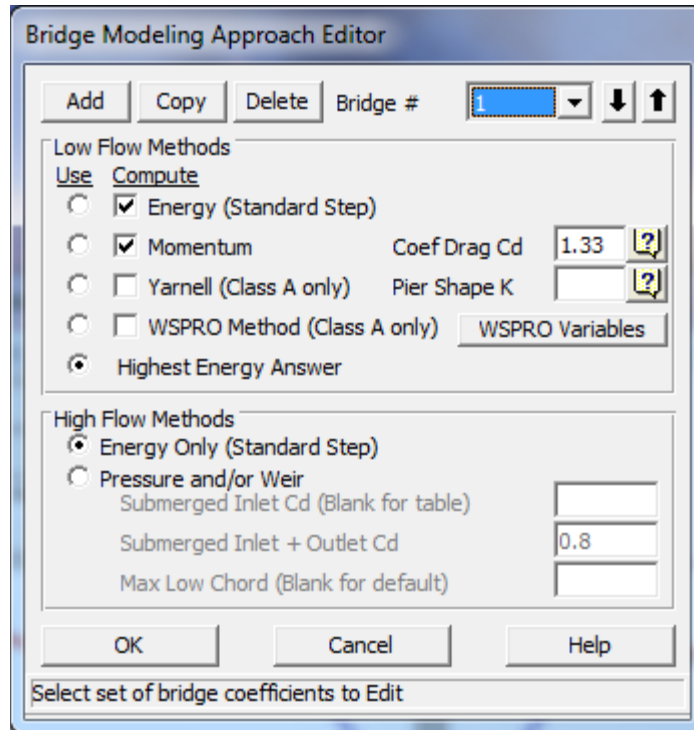

Figure 9-6: Bridge Modeling Approach Editor for Energy Method Analysis

This concluded the geometric input for the analysis and the data was then saved as "Base Geometry Data - Energy." Next, the steady flow data were entered for the simulation.

## Steady Flow Data

To enter the steady flow data, first the profile data and then the boundary conditions were entered. These data components are discussed below.

### Profile Data

To enter the steady flow profile data, from the main program window **Edit** and then **Steady Flow Data** were selected. This activated the **Steady Flow Data Editor** as shown in Figure 9.7. On the top row of the editor, the number of profiles was chosen to be one. When this number was entered, the table portion of the editor adjusted for this number of profiles. Then, the 100-year flow rate of 3200 cfs was entered at the upstream end of the river reach; there were no flow change locations. Finally, the boundary conditions were entered.

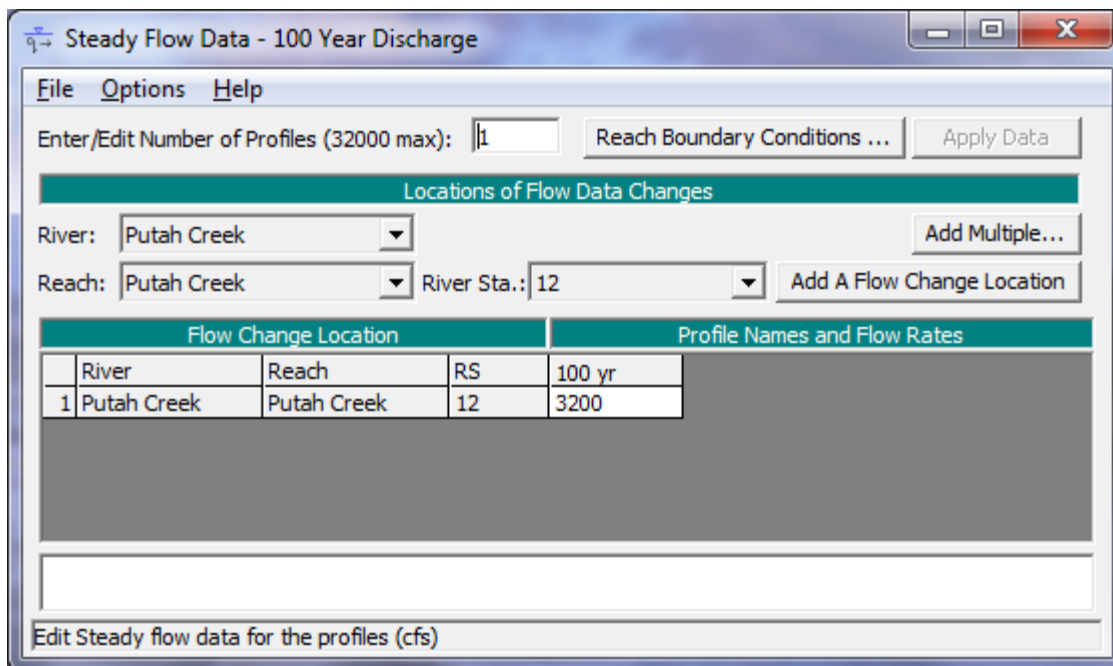

Figure 9-7: Steady Flow Data for Puta Creek

## Boundary Conditions

To enter the boundary conditions, the **Boundary Conditions** icon was selected from the **Steady Flow Data Editor** (Figure 9.7). This activated the **Boundary Conditions Data Editor** as shown in Figure 9.8. Since the flow through the river reach is supercritical, the analysis will be performed in the mixed flow regime. This will allow for the computations of both subcritical and supercritical flow profiles, if they are found to occur. Therefore, the user must enter both an upstream and a downstream boundary condition. As can be seen in Figure 9.8, a *Normal Depth* upstream boundary condition was selected with a slope of 0.01 ft/ft. Additionally, a downstream boundary condition was selected as *Critical Depth*. The selection of these boundary conditions will be discussed in the analysis of the output. For additional discussion on boundary conditions, the modeler is referred to chapter 7 of the **User's Manual**. At this point, the flow data was saved as "100 Year Discharge."



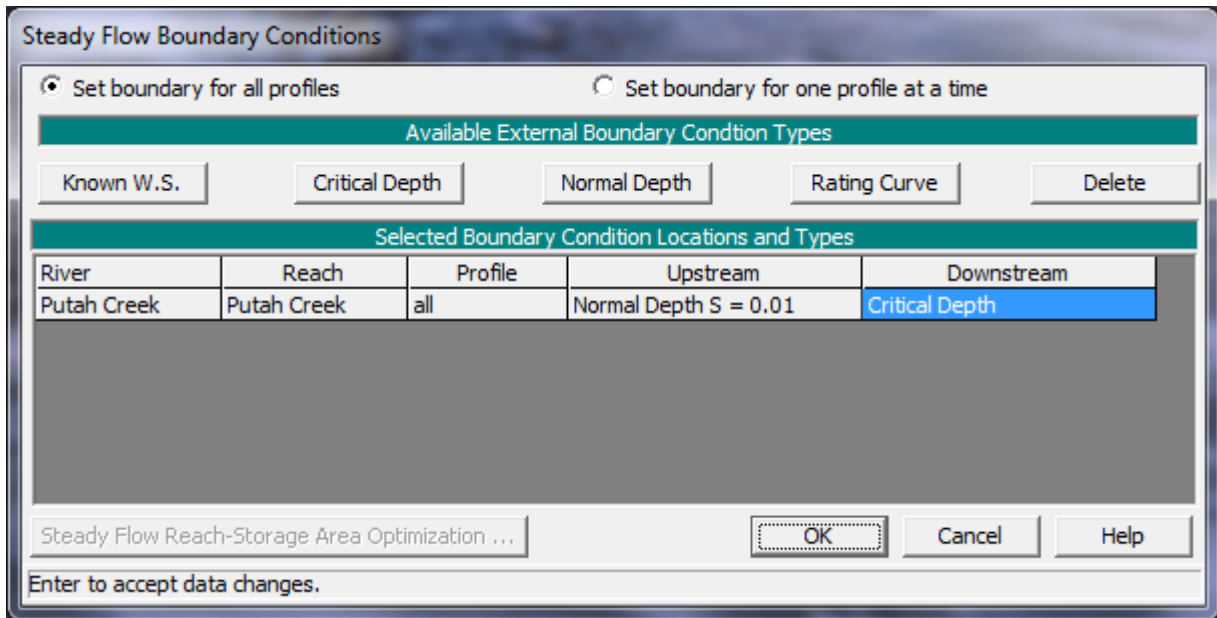

Figure 9-8: Steady Flow Boundary Conditions

## Steady Flow Analysis

After all of the geometric and steady flow data were entered, the steady flow analysis was performed. This was accomplished by selecting from the main menu **Run** and then **Steady Flow Analysis**. This activated the **Steady Flow Analysis Window** as shown in Figure 9.9.

As shown in Figure 9.9, first a **Short ID** was entered as "Energy." Then the geometry file "Base Geometry Data - Energy" and the steady flow file "100 Year Discharge" were selected by using the down arrows on the right side of the window. (Note: The selection of these files was not necessary since there existed only one geometry file and only one flow file at this time.) Then the **Flow Regime** was selected as "Mixed" and the information was saved as a plan by selecting **File** and then **Save Plan As**. The title "Putah Creek Bridge - Energy" was entered and the **OK** button was selected. Then this plan title appeared at the top of the steady flow window (as well as on the main program window). Finally, the **COMPUTE** button was selected to perform the analysis.

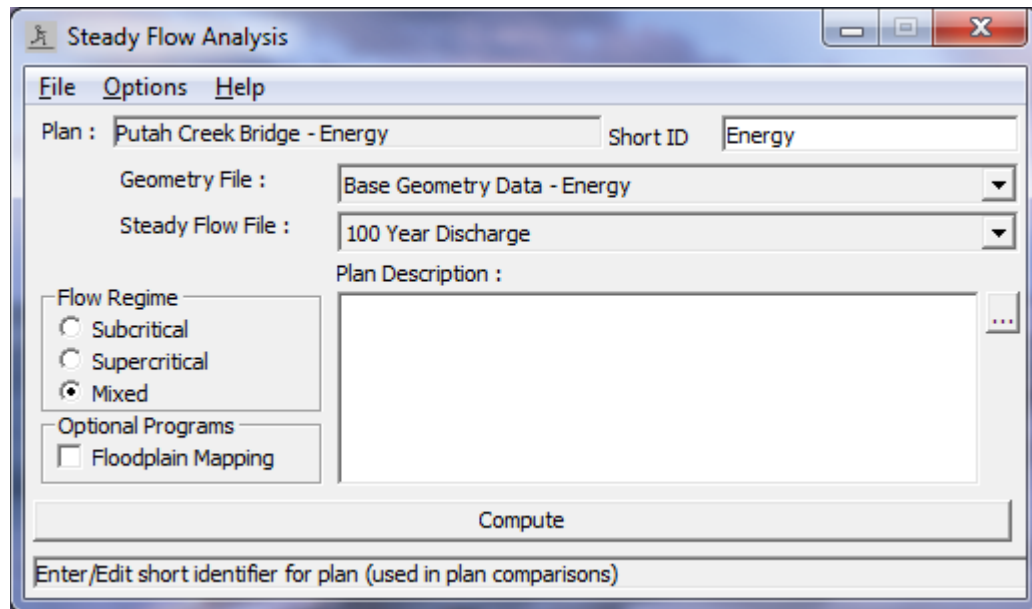

Figure 9-9: Steady Flow Analysis Window

## Review of Output for Energy Analysis

The modeler can review the output in both graphical and in tabular form. For this analysis, first the water surface profile was plotted and then the profile table and the cross section table for the bridge were reviewed.

### Water Surface Profile

To view the water surface profile, from the main program window select **View** and then **Water Surface Profiles**. This will display the profile as shown in Figure 9.10. The profile shows the energy gradeline, the water surface, and the critical depth for the flow of 3200 cfs (the only flow for this example).

To perform the mixed flow analysis, the program will first compute a subcritical flow profile for the entire river reach starting at the downstream river station. The program will flag any location that defaulted to critical depth. Next, the program will perform a supercritical analysis for the river reach starting at the upstream river station. During this phase, the program will compare the specific force for the supercritical flow to the specific force for the subcritical flow at any river station that has a valid answer in both flow regimes. The flow regime with the greater specific force will control at that river station. For a further discussion on mixed flow analysis, the user is referred to the section "Mixed Flow Regime Calculations" in chapter 4 of the **Hydraulic Reference Manual**.

For this example, it can be seen in Figure 9.10 that the flow is supercritical at the upstream end of the river reach because the water surface is below the critical depth line. This was determined by comparing the specific force of the user defined upstream normal depth boundary condition with the subcritical flow answer. The program had determined that the specific force of the supercritical flow boundary condition was greater than that of the subcritical flow answer and therefore used the upstream boundary condition. The

program then continued in the downstream direction with a supercritical flow profile.

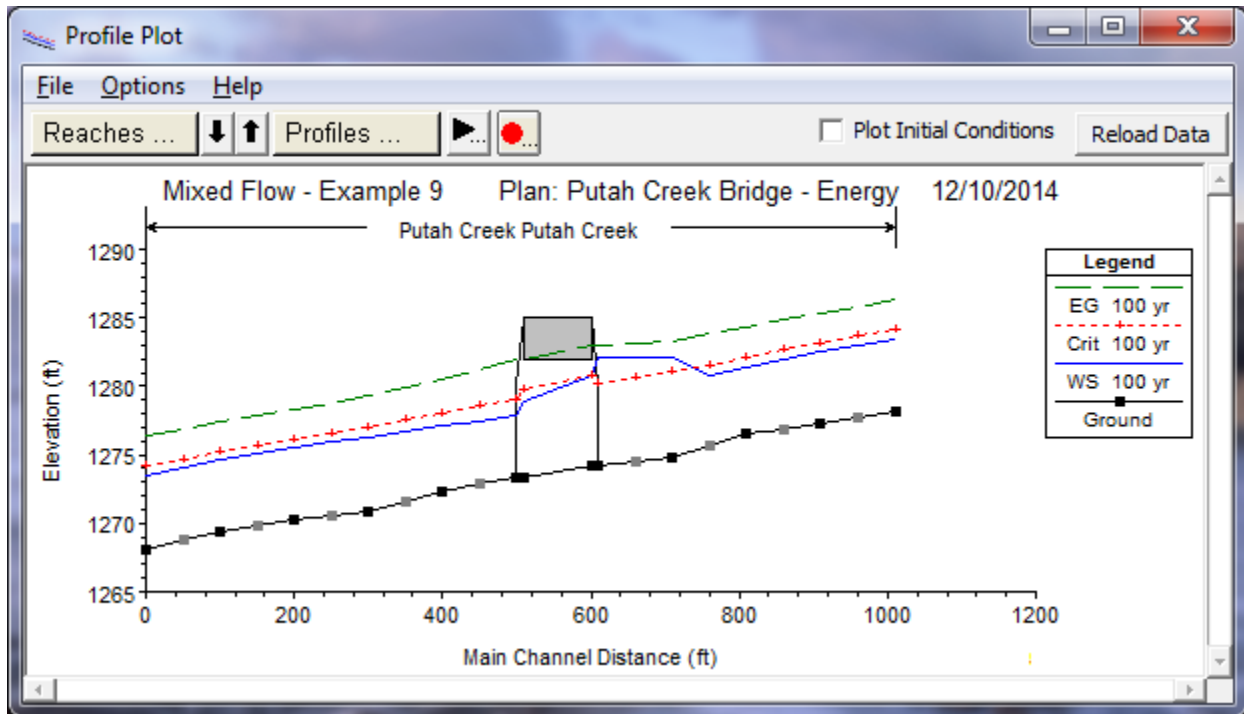

Figure 9-10: Water Surface Profile for Energy Analysis With Mixed Flow Regime

When the program calculated the water surface profile for river station 9, it determined that there was a valid answer for both the subcritical and supercritical flow profiles. The program then compared the specific force of both of these flow regimes and determined that the subcritical flow had a greater specific force. This implies that the flow at river station 9 was subcritical and that a hydraulic jump developed upstream of this river station. This can be seen in Figure 9.10 to have occurred between the main channel stations of 710 and 760 (river stations 9 and 9.5\*). This hydraulic jump occurred because the cross section geometry in the vicinity of the bridge caused a constriction of the flow and a backwater was created upstream from the bridge. This backwater created a subcritical profile immediately upstream of the bridge and a hydraulic jump was necessary for the flow to transition from supercritical to subcritical.

Reach	River Sta	Profile	Q Total (cfs)	Min Ch El (ft)	W.S. Elev (ft)	Crit W.S. (ft)	E.G. Elev (ft)	E.G. Slope (ft/ft)	Vel Chnl (ft/s)	Flow Area (sq ft)	Top Width (ft)
Putah Creek	11	100 yr	3200.00	1277.30	1282.55	1283.17	1285.35	0.009623	13.42	238.45	66.92
Putah Creek	10.5*	100 yr	3200.00	1276.90	1281.98	1282.64	1284.85	0.009900	13.59	235.50	66.28
Putah Creek	10	100 yr	3200.00	1276.50	1281.43	1282.11	1284.35	0.010073	13.70	233.51	65.76
Putah Creek	9.5*	100 yr	3200.00	1275.65	1280.84	1281.58	1283.82	0.010349	13.85	230.97	65.28
Putah Creek	9	100 yr	3200.00	1274.80	1282.09	1281.03	1283.33	0.002959	8.94	358.01	76.43
Putah Creek	8.5*	100 yr	3200.00	1274.50	1282.09	1280.61	1283.14	0.002235	8.21	390.58	81.22
Putah Creek	8	100 yr	3200.00	1274.20	1282.10	1280.19	1283.00	0.001717	7.58	425.67	88.78
Putah Creek	7	Bridge									
Putah Creek	6	100 yr	3200.00	1273.40	1277.81	1279.09	1281.99	0.017195	16.42	194.92	62.69
Putah Creek	5.5*	100 yr	3200.00	1272.85	1277.49	1278.59	1281.17	0.014199	15.38	208.07	63.87
Putah Creek	5	100 yr	3200.00	1272.30	1277.12	1278.05	1280.47	0.012406	14.69	217.86	64.71
Putah Creek	4.5*	100 yr	3200.00	1271.60	1276.72	1277.56	1279.87	0.011205	14.21	225.12	65.03

Total flow in cross section.

Figure 9-11: Standard Table 1 Profile Table for Energy Method Analysis

To view the calculated values of the water surface elevations, critical depth, and energy gradeline, the Standard Table 1 profile table was activated from the main program window by selecting View, Profile Summary Tables, and then Std. Table 1. This table is shown as Figure 9.11 and shows a water surface elevation of 1280.84 and a critical water surface elevation of 1281.58 at river station 9.5\*. This water surface elevation is less than the critical depth and implies a supercritical flow regime. At river station 9, the water surface elevation of 1282.19 is greater than the critical water surface of 1281.03 and implies a subcritical flow regime. The modeler can use this table to determine all of the computed values that are displayed on the profile plot as shown in Figure 9.10.

Referring back to Figure 9.10, as the calculations continued through the bridge, Class B low flow was found to occur since the flow did not encounter the low cord of the bridge and the flow passed through critical depth under the bridge. For Class B low flow, the program will set the water surface at critical depth at either the upstream inside or downstream inside cross section of the bridge. The program will calculate the specific force for critical depth at both of these sections and set the flow at critical depth at the section that is the most constricted and has the greater specific force. For this example, the flow was set at critical depth at the bridge upstream inside cross section, as shown in Figure 9.10. Additionally, if the specific force of both cross-sections are approximately equal, then the program will use the location entered by the user. The location can be selected from within the Bridge/Culvert Data Editor by selecting Options and then Momentum Class B defaults.

Finally, a supercritical profile continued downstream of the bridge to the last downstream cross section. The downstream boundary condition had been set at critical depth. However, the program determined that the supercritical flow solution at the downstream end had a greater specific force than the boundary condition and used the supercritical flow answer.

## Water Surface Profiles for Subcritical and Supercritical Flow Analyses

To perform the analysis, the mixed flow regime had been selected. If the user had selected a subcritical or supercritical flow regime for the analysis, the output would have reflected various warnings and notes intended to alert the user of possible inconsistencies with the results. For example, if the user had selected a subcritical flow regime, the water surface profile would have appeared as shown in Figure 9.12.

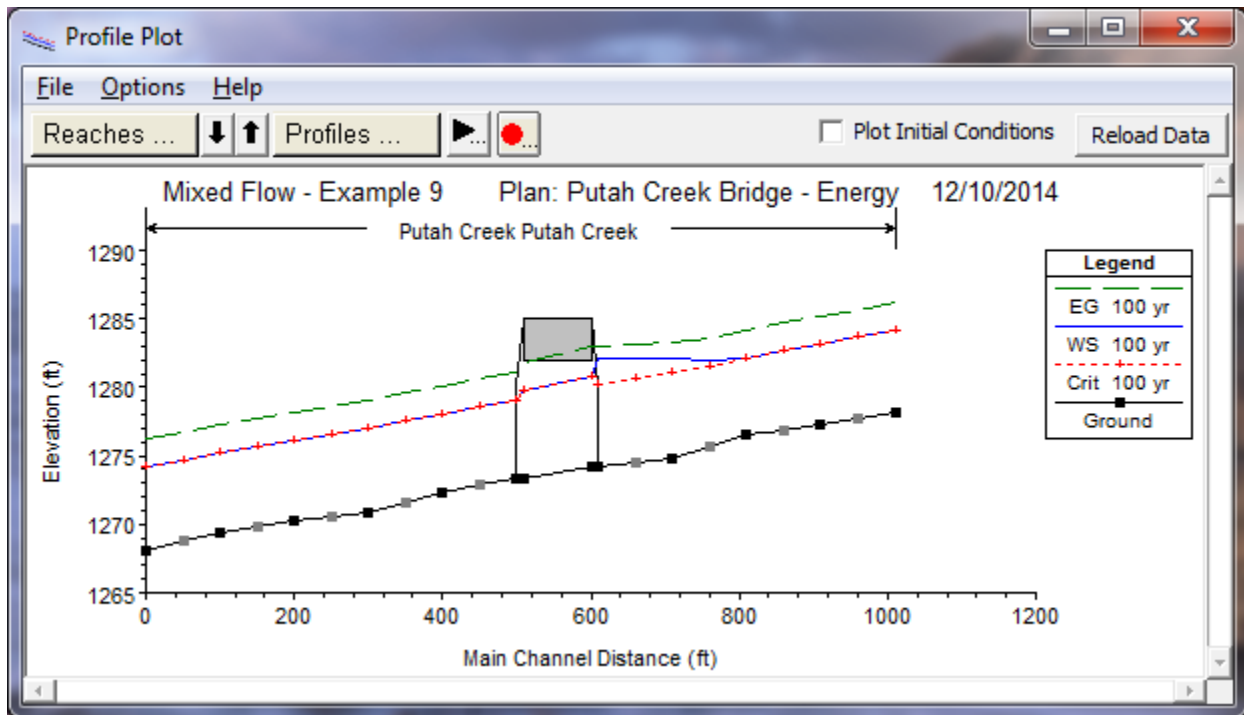

Figure 9-12: Water Surface profile for Energy Analysis with Subcritical Flow Regime

As can be seen in Figure 9.12, the water surface coincided with the critical depth line for the majority of the river stations. A review of the **Summary of Errors, Warnings and Notes** would reveal the repetition of the warning: "During the standard step iterations, when the assumed water surface was set equal to critical depth, the calculated water surface came back below critical depth. This indicates that there is not a valid subcritical answer. The program defaulted to critical depth." This warning is issued when the user has requested a subcritical flow analysis but the program could not determine a subcritical flow depth at the specified cross section. Since a subcritical solution was not possible, the program used critical depth at this location and continued on with the calculations. This warning may be associated with too long of reach lengths between cross sections or the fact that the flow analysis should be performed in the supercritical or mixed flow regimes.

If the user had selected to perform a supercritical flow analysis, the water surface profile would have appeared as shown in Figure 9.13. As can be seen in the figure, there is an inconsistent drop in the energy gradeline immediately upstream of the bridge. A review of the warnings at the upstream inside bridge cross section revealed that the energy equation could not be balanced within the specified number of iterations and the program defaulted to critical depth at this location. The user should perform the

computations in the mixed flow regime to determine if a subcritical flow profile exists in the river reach. The program can only provide for both subcritical and supercritical flow answers when the mixed flow regime is selected.

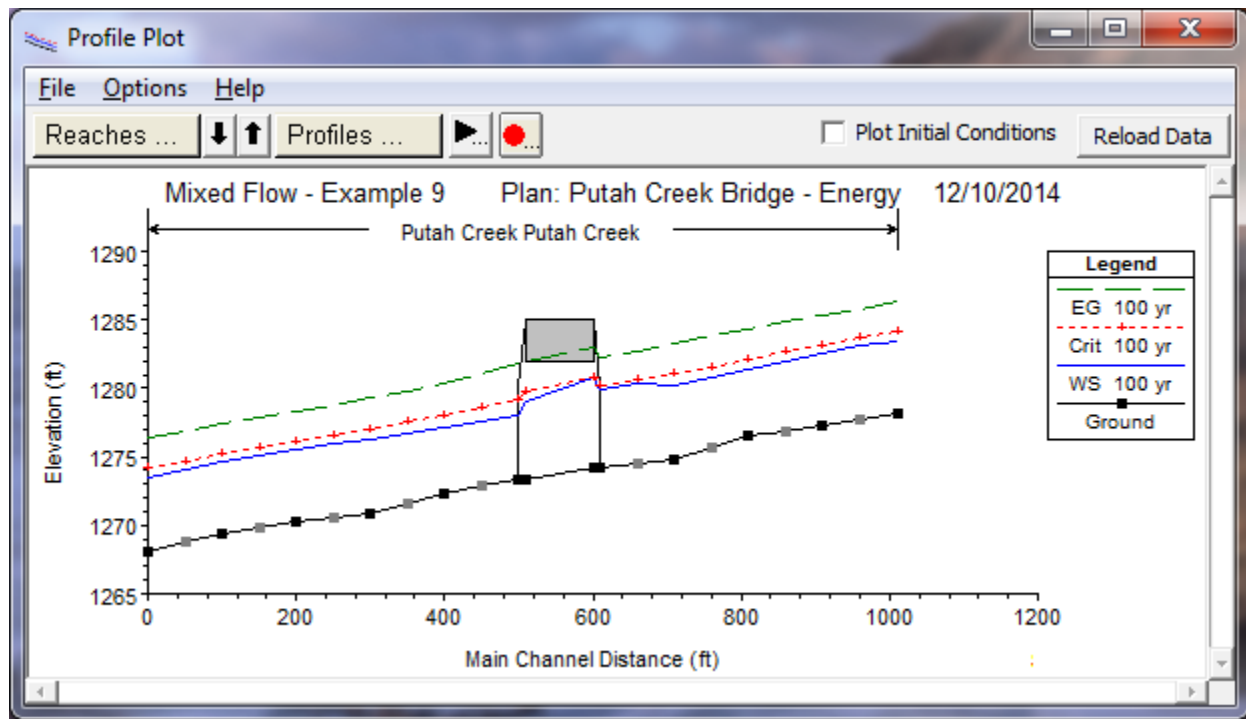

Figure 9-13: Water Surface profile for Energy Analysis with Supercritical Flow Regime

The analysis of the river reach in the subcritical and supercritical flow regimes are not provided as plans for this example. They were computed and presented to show what would develop if these flow regimes had been selected. However, the modeler can readily select these other flow regimes and execute the program to observe the output. For an additional discussion for the descriptions of the warnings, errors, and notes, the user is referred to example 1 and to chapter 10 of the **User's Manual**.

### Profile Table - Bridge Comparison

Returning to the mixed flow analysis of the river reach, it was observed that during the flow event, Class B low flow was found to occur at the bridge. For the low flow analysis, the energy and the momentum methods had been selected to be computed for the analysis in the **Bridge Modeling Approach Editor**. To determine which method the program used for the final answer, from the main program window select **View, Profile Summary Table, Std. Tables**, and then **Bridge Comparison**. This will activate the Bridge Comparison Profile Table as shown in Figure 9.14.

Reach	River Sta	Profile	E.G. US. (ft)	W.S. US. (ft)	Br Sel Method	Energy EG (ft)	Momen. EG (ft)	Yarnell EG (ft)	WSPRO EG (ft)	Prs O EG (ft)	Prs/Wr EG (ft)	Energy/Wr EG (ft)
Putah Creek	7	100 yr	1283.00	1282.10	Momentum	1283.07	1283.00					

Upstream energy grade elevation at bridge or culvert (specific to that opening, not necessarily the weighted average).

Figure 9-14: Bridge Comparison Profile Table for Energy Method Analysis

The first two columns in the table show the reach and river station for the bridge location. For this example, the bridge is located at river station 7. The third column shows the energy gradeline elevation that was used as the final answer for the analysis, 1283.00 ft. The fourth column displays the water surface elevation (1282.21 ft) that corresponds to the energy gradeline in column three. The fifth column displays the bridge method that was selected as the final answer. Finally, the sixth and seventh columns show the results of the energy and momentum methods since these two methods were selected to be computed. As can be seen in the table, the energy low flow method produced a result of 1283.07 ft for the energy gradeline. The momentum method produced a result of 1283.00 for the upstream energy gradeline, and was selected as the final bridge solution. The reason the momentum method was selected, instead of the highest upstream energy answer, is that the bridge is in a class B flow regime (passing from subcritical, through critical, and going supercritical) inside of the bridge. For this type of flow regime, HEC-RAS uses the Momentum equation as the best answer, due to the rapidly varying flow (i.e. the energy method does not perform as well in rapidly varying flow regimes – where flow passes through critical depth, and may go through a hydraulic jump). The only time the momentum method is not used for Class B low flow is if it fails to converge on an answer, then the energy method will be used.

### Cross Section Table - Bridge

As an additional review of the output for the bridge, the cross section table was activated from the main program window by selecting **View, Cross Section Table, Type**, and then **Bridge**. This displayed the **Bridge Cross Section Table** as shown in Figure 9.15. For this example, there was only one bridge located on Putah Creek at river station 7. The left side of the table shows the energy and water surface elevations for the river station immediately upstream of the bridge (as shown in Figure 9.14). The right side of the table displays information for the two cross sections located inside of the bridge. The bottom portion of the table displays any errors, warnings, and notes for the cross section. As is shown in Figure 9.15, two of the notes that appear at this river station notify the modeler that Class B low flow was computed for this bridge structure. Whenever Class B low flow is found to occur, the modeler should perform the analysis in the mixed flow regime mode.

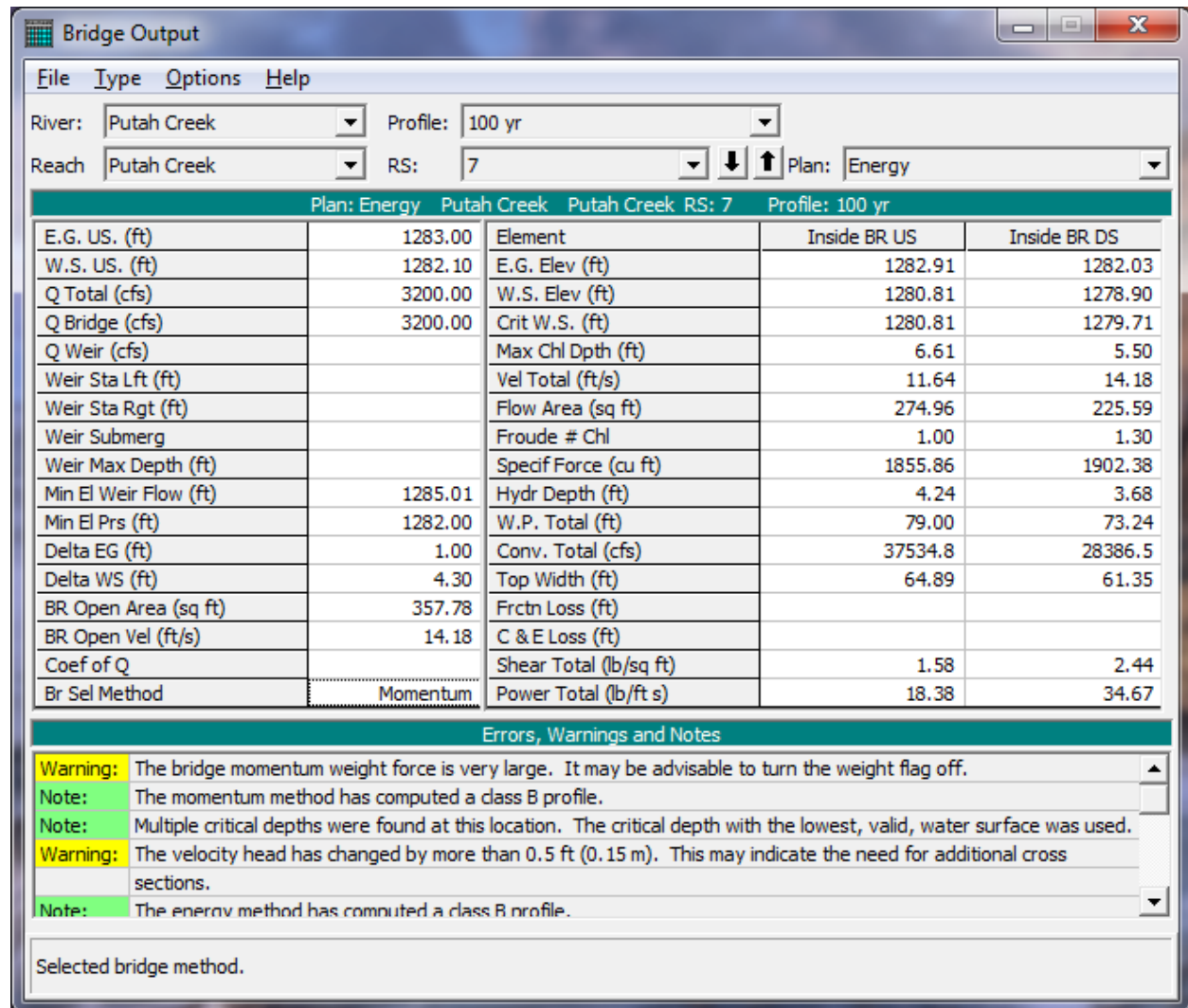

Figure 9-15: Bridge Type Cross-Section Table for Energy Method

This completed the review for the energy method analysis. As a final review of the water surface profile as shown in Figure 9 -10, it can be seen that the water surface upstream of the bridge did not encounter the bridge decking for the energy method analysis and therefore was calculated as a low flow profile. However, the water surface elevation is very close to the bridge decking and, due to the turbulent wave action of the flow, may jump to pressure flow during the event. Therefore, an additional analysis was performed with the pressure/weir flow option selected for the high method. This is discussed further in the next section.

## Pressure/Weir Analysis

The water surface profile in the vicinity of the bridge was calculated as low flow for the energy method analysis. However, for a pressure flow analysis, the program will compare the energy gradeline value of the flow with the low cord of the bridge decking to determine when pressure flow will begin to occur. As can be seen in Figure 9.10, the energy gradeline elevation is greater than the low cord at the upstream side of the bridge. Therefore, the



river reach was re-analyzed using the pressure/weir method for the high flow computations.

To select the pressure/weir method, the geometry file “Base Geometry Data - Energy” was activated. Then the **Bridge/Culvert** icon and the **Bridge Modeling Approach** icon were selected. The “Pressure/Weir Method” was then chosen for the high flow analysis. This **Bridge Modeling Approach Editor** is shown as Figure 9.16.

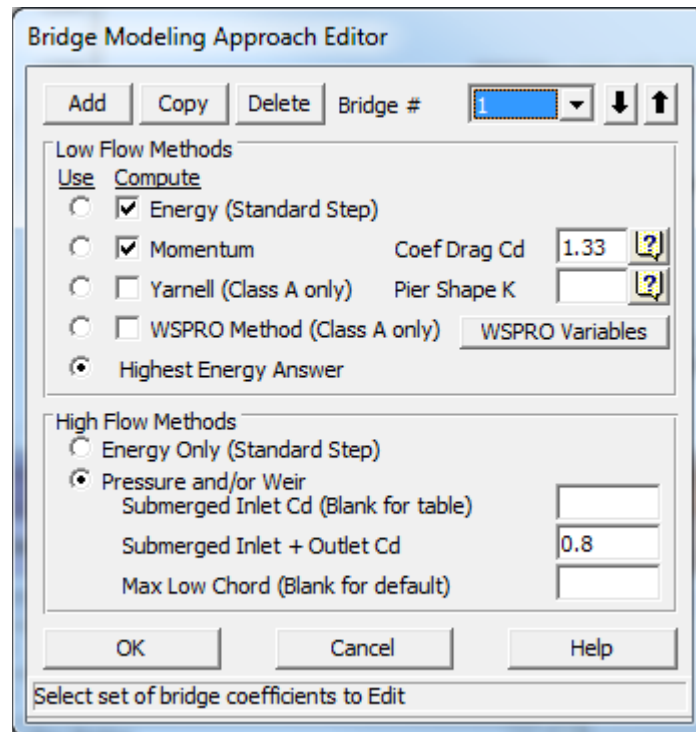

Figure 9-16: Bridge Modeling Approach Editor for Pressure/Weir Flow Analysis

For the pressure/weir analysis, the editor allows three input coefficients. The first coefficient is for the flow situation when only the upstream side of the bridge decking is submerged. For this example, the field was left blank so that the table values would be used by the program. The second coefficient is for the flow situation when both the upstream and downstream sides of the bridge decking are submerged. This coefficient was left at a value of 0.8, the default value. The final field is for the modeler to enter an elevation value for the program to use to determine when to begin the pressure flow calculations. Pressure flow calculations will begin when the low flow energy gradeline value is greater than the value entered in this field. If the field is left blank (as for this example), then the program will use the highest low chord of the bridge decking on the upstream side. Once all of the data had been entered, the editor was closed by selecting the **OK** button.

Next, the ineffective flow areas were added at river station 8 (the river station located immediately upstream of the bridge). A left ineffective flow area was set to begin 10 feet to the left of the bridge opening and a right ineffective flow area was set to begin 10 feet to the right of the right side of the bridge opening. Both of these ineffective flow areas were set at an elevation of 1285 feet, the high cord elevation of the bridge.

Then, the geometry file was saved as "Base Geometry Data - Press/Weir." Next, this geometry file and the steady flow data file were saved as a plan. This was performed by first activating the **Steady Flow Analysis Window** from the main program window. The steady flow window is shown in Figure 9.17. Then, the geometry and steady flow file were selected by depressing the down arrows on the right side of the window.

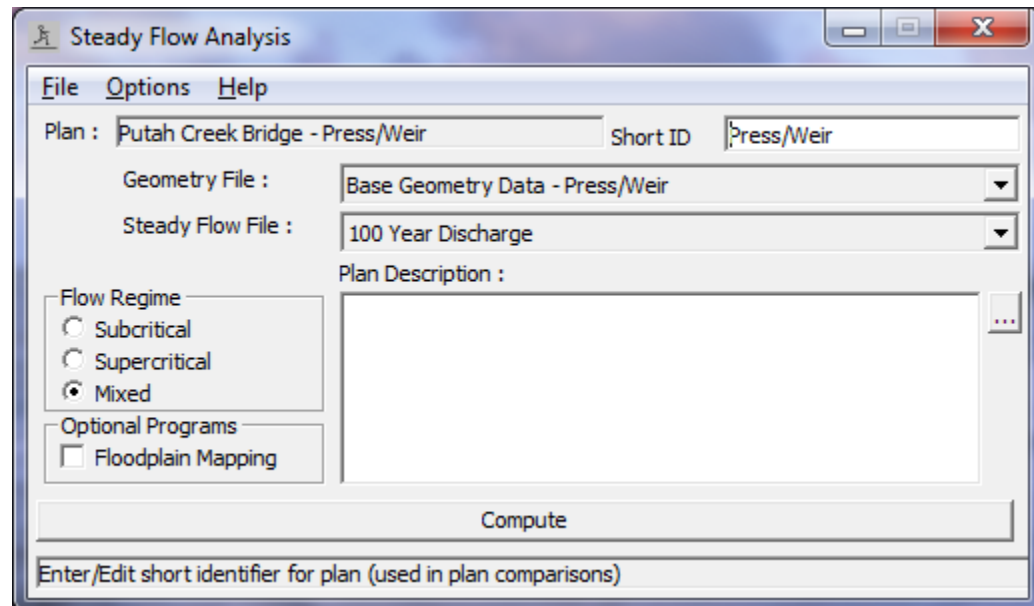

Figure 9-17: Steady Flow Analysis Window for Pressure/Weir Analysis

Next, the **Short ID** "Press/Weir" was entered in the upper right corner of the editor and the flow regime "Mixed" was selected. Finally, **File** and **Save Plan As** were selected and the title "Putah Creek Bridge - Press/Weir" was entered. This created a new plan with the pressure/weir geometry file and the steady flow data file. The plan name then appeared at the top of the steady flow analysis window (as well as on the main program window).

After the new plan was created, the **COMPUTE** button was depressed to activate the calculations of the water surface profile. The user can activate this plan by selecting **File, Open Plan**, and then the plan "Putah Creek Bridge - Press/Weir" to review the remaining discussion of this example.

## Review of Output for Pressure/Weir Analysis

For the output for the pressure/weir analysis, this discussion will review the water surface profile, the expansion and contraction reach lengths, the bridge comparison table, the bridge cross section table, and finally the 3-D plot.

### Water Surface Profile

The water surface profile for the pressure/weir analysis is shown in Figure 9.18. As can be seen in the figure, the upstream water surface profile begins in the supercritical flow regime. However, the energy gradeline at the cross section immediately upstream of the bridge was greater than the highest value of upstream low cord. Therefore, during the computations, pressure

flow was found to occur and the water surface profile developed as pressure flow through the bridge. This pressure flow caused a backwater effect and created a subcritical flow profile upstream of the bridge. For the flow to transition from a supercritical to a subcritical profile, a hydraulic jump occurred in between river stations 11 and 11.5\*.

The flow through the bridge structure is again Class B flow because the flow passed through critical depth within the bridge. Finally, the downstream profile is supercritical to the downstream cross section. As before, it was necessary to perform the analysis in the mixed flow regime in order to obtain a water surface profile in both the subcritical and supercritical flow regimes.

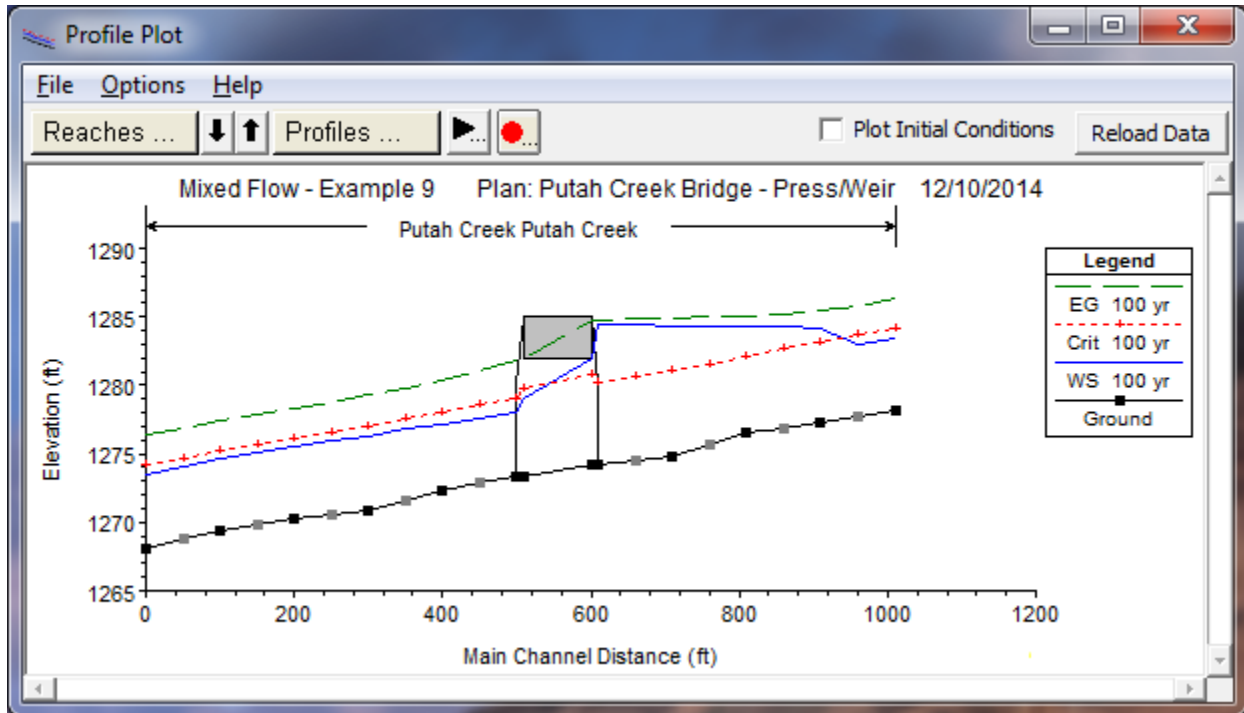

Figure 9-18: Water Surface profile for Pressure/Weir Flow Analysis

### Expansion and Contraction Reach Lengths

As stated previously, the locations of the cross sections in the vicinity of a bridge are crucial for the accurate prediction of the energy losses through the structure. For this example, the distance from river station 6 to 5.5 \* defines the expansion reach length and the distance from river station 8.5\* to 8 defines the contraction reach length. Each of these reach lengths are evaluated below based upon the procedures as outlined in appendix B of the **Hydraulic Reference Manual**. However, these procedures were developed based on subcritical flow through bridges. Therefore, only the table values will be used to provide a general guidance for the reach lengths.

**Expansion Reach Length.** To estimate the expansion reach length from Table B.1, the following information was required:

$$b = 90$$

$$B = 190$$

$$b/B = 0.50$$

$$S = 50$$

$$n_{ob}/n_c = 0.035/0.025 = 1.4$$

$$L_{obs} = 45$$

where:	$b$	=	bridge opening width, ft
	$B$	=	floodplain width, ft
	$S$	=	bed slope, ft/mi
	$n_{ob}$	=	Manning's n value of the overbank
	$n_c$	=	Manning's n value of the main channel
	$L_{obs}$	=	average length of obstruction, ft

From Table B.1, the expansion ratio (ER) was determined to be in the range from 1.2 - 1.5. Using an average value of 1.3 yields an expansion reach length ( $L_e$ ) of:

$$L_e = (ER)(L_{obs}) = (1.1)(45) = 50 \text{ feet}$$

From the geometric data, the distance from river station 6 to 5.5\* was set at 50 feet. This value is approximately equal to the expansion reach length as determined above and the location of the river stations were not adjusted.

**Contraction Reach Length.** To estimate the contraction reach length, the contraction ratio from Table B.2 was determined to be in the range from 0.8 - 1.4. Using an average value of 1.1 yielded a contraction reach length ( $L_c$ ) of:

$$L_c = (CR)(L_{obs}) = (1.1)(45) = 50 \text{ feet}$$

From the geometric data, the contraction reach length was set to be 50 feet. For this example, the flow in the main channel did not exhibit a large degree of contraction or expansion losses. This allowed for shorter expansion and contraction reach lengths, as determined above. As stated previously, the table values were used as a general guide, because the data of the example were not within the range of the data used to develop the regression equations.

### Bridge Comparison Table

As was shown in Figure 9.18, the water surface reflected pressure flow through the bridge structure. To determine why this energy value was selected, the user can review the Bridge Comparison Table. This table is activated from the main program window by selecting View, Profile Summary Table, Std. Tables, and then Bridge Comparison. This table is shown in Figure 9.19.

As described previously, the first two columns in the table show the reach and river station of the bridge location. The third column shows the bridge method that was used as the final answer. The fourth column shows the final energy gradeline value used for the analysis. The fifth column shows the water surface that corresponds to the energy value in column four. The next four columns (Energy, Momentum, Yarnell, and WSPRO) show the calculated energy gradeline values for these low flow methods. For this example, only the energy and the momentum methods were selected to be calculated for the low flow analysis. The solution of the energy gradeline for the energy method is 1282.22 feet. The momentum method produced an answer of 1282.99 feet. Therefore, the program used the value of 1282.99 as the answer for the low flow analysis (this is not necessarily the final answer as is discussed subsequently).

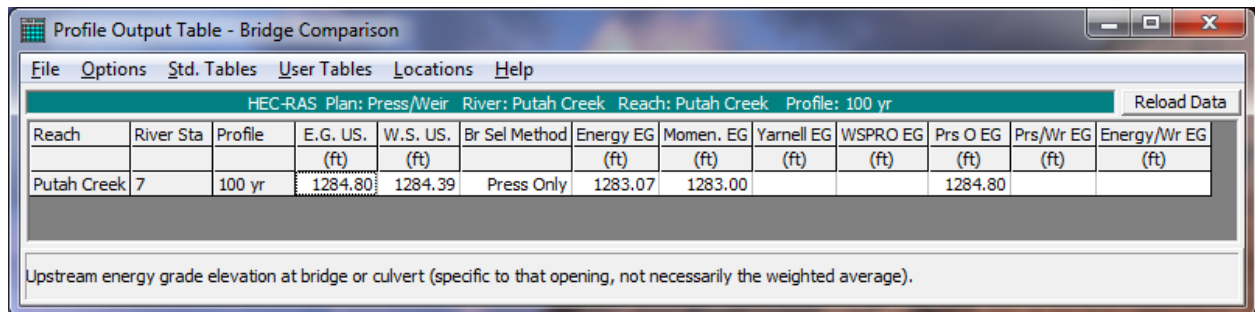

Reach	River Sta	Profile	E.G. US. (ft)	W.S. US. (ft)	Br Sel Method	Energy EG (ft)	Momen. EG (ft)	Yarnell EG (ft)	WSPRO EG (ft)	Prs O EG (ft)	Prs/Wr EG (ft)	Energy/Wr EG (ft)
Putah Creek	7	100 yr	1284.80	1284.39	Press Only	1283.07	1283.00			1284.80		

Upstream energy grade elevation at bridge or culvert (specific to that opening, not necessarily the weighted average).

Figure 9-19: Bridge Comparison Table for Pressure/Weir Flow Analysis

The tenth column (Prs O EG) displays the energy gradeline necessary for only pressure flow to be occurring through the bridge. For this example, this value is 1284.80 feet. The program then compared this pressure only energy gradeline to the energy gradeline that was used for the low flow analysis (1283.07). The greater of the two values was then used as the final answer. For this example, the pressure only energy gradeline was the greater value and the program then used the pressure only method as the final solution.

The ninth column (Prs/Wr EG) shows the calculated energy gradeline value for the situation when both pressure and weir flow would occur. This situation did not develop for this example. For a further discussion for bridge analyses, the user is referred to example 2 and to chapter 6 of the **User's Manual** and chapter 5 of the **Hydraulic Reference Manual**.

### Bridge Detailed Output Table

As a final table for the review of the pressure/weir flow, the user can select the Bridge Detailed Output Table. This is activated from the main program window by selecting **View, Detailed Output Table, Type**, and then Bridge. This will display the table as shown in Figure 9.20.

As discussed previously, the left side of the table shows the energy gradeline and the water surface for the cross section immediately upstream of the bridge. (These values are the same as was shown in Figure 9.19.) Additionally, the left side of the table shows that there was no weir flow occurring over the bridge decking. The right side of the table displays information for the two cross sections located inside of the bridge.

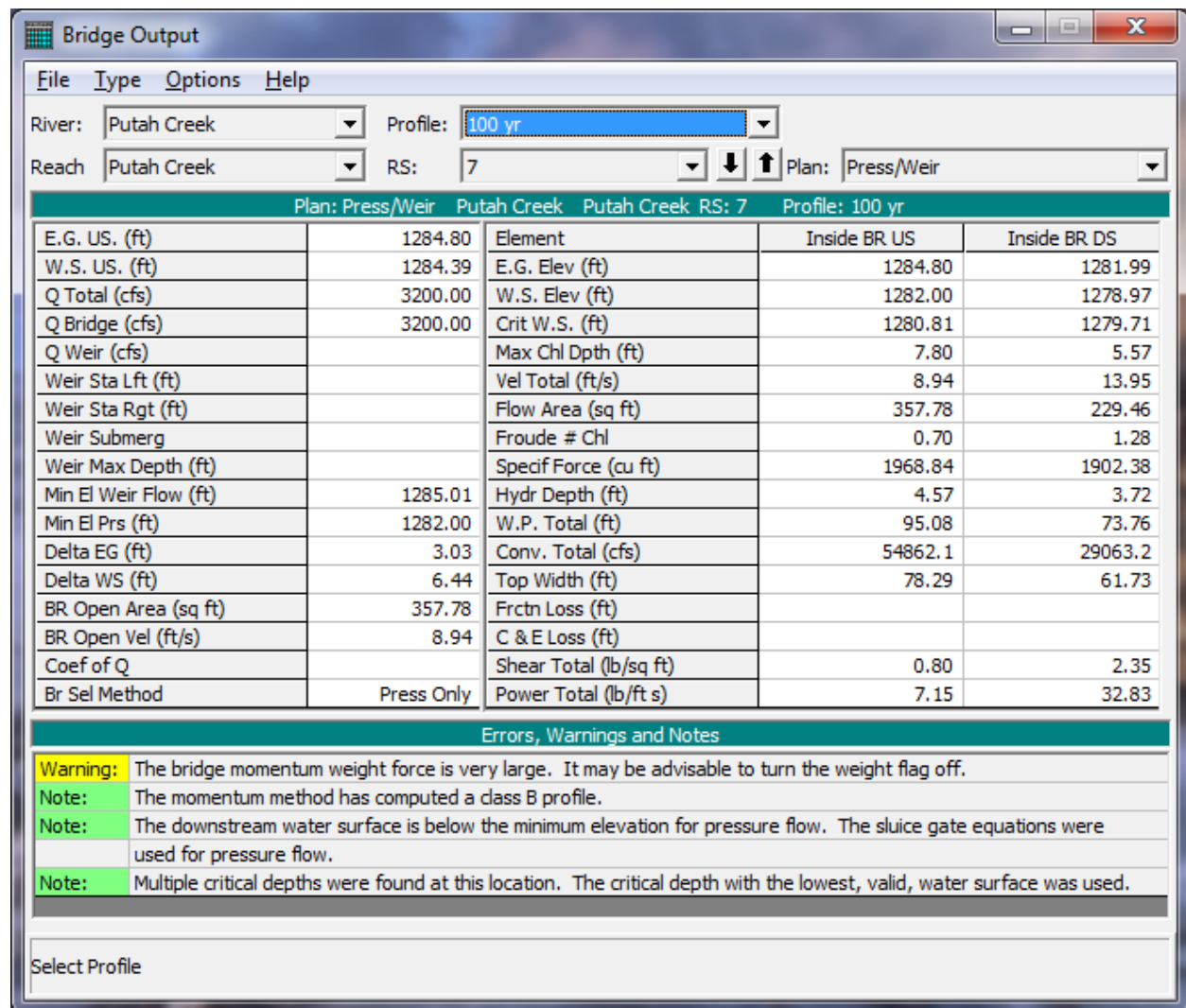

Figure 9-20: Bridge Detailed Output Table for Pressure/Weir Flow Analysis

The bottom of the table displays the errors, warnings, and notes for the river station. At this bridge location, the notes shown in the figure indicated that the sluice gate equation was used for pressure flow. This equation was used because the water surface elevation at the river station immediately below the bridge was less than the lowest value of the low cord for the bridge.

### X-Y-Z Perspective Plot

As a final review of the pressure/weir flow analysis, the **X-Y-Z Perspective plot** was viewed. This plot was activated from the main program window by selecting **View** and then **X-Y-Z Perspective Plots**. This plot is shown as Figure 9.21. The user must be aware of the fact that this plot can be aligned according to left or right edges of the cross sections or by the main channel left, centerline, or right bank stations. Additionally, the alignment is based upon the X-coordinates as entered by the user. If the X-coordinates for the cross sections are not all established from the same left baseline, then the plot may not be accurately portraying the correct configuration of the river system.

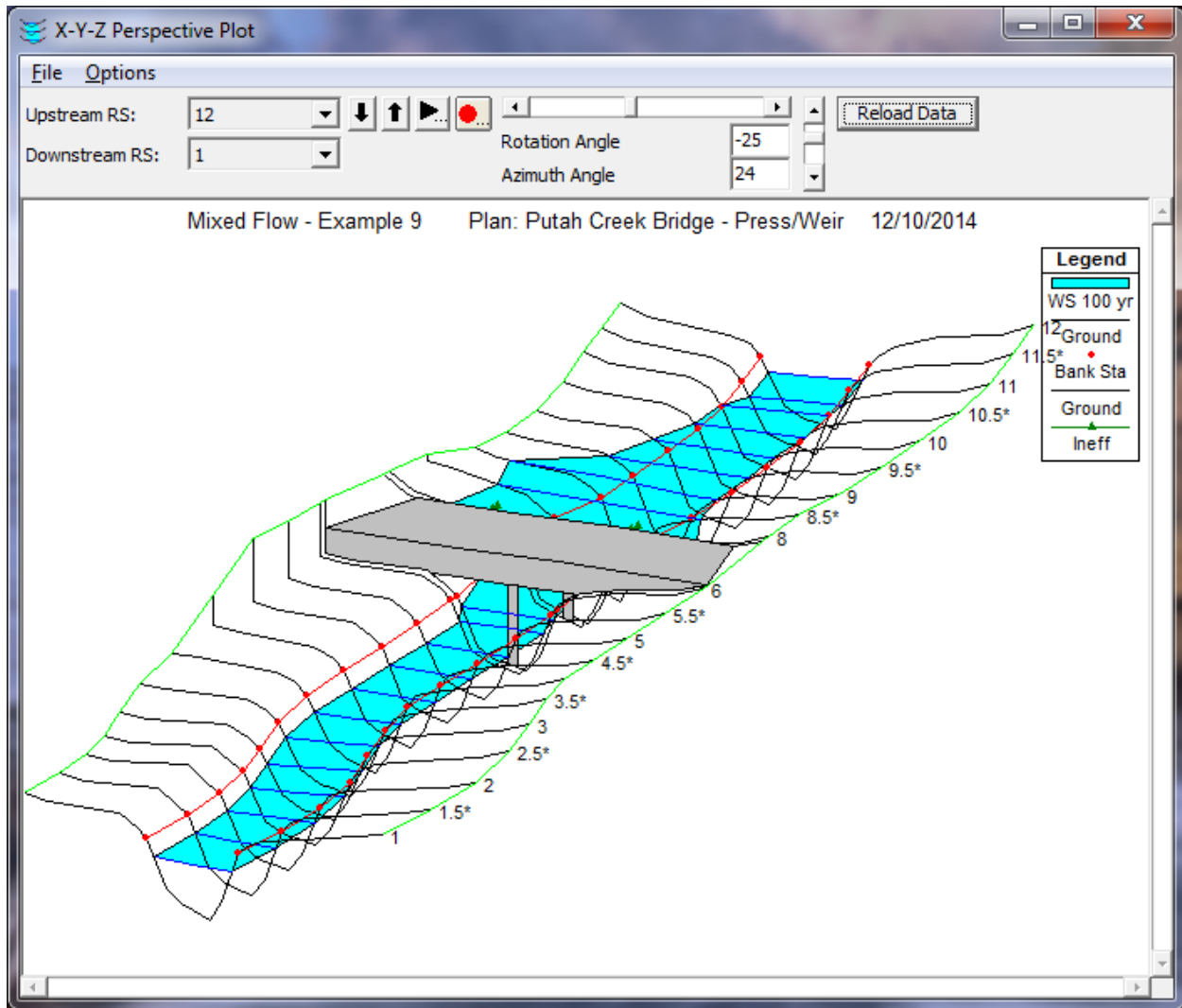

Figure 9-21: X-Y-Z Perspective Plot for Pressure/Weir Analysis

## Summary

As a summary for this example, a profile plot for both the energy and pressure flow analysis is shown as Figure 9.22. Once the plot was activated, **Options** and **Plans** were chosen and both plans were selected to be displayed. The heading at the top of the figure displays the Short ID's that were used for each plan : 1) Energy and 2) Press/Weir. The legend displays two lines for the critical depth and two lines for the water surface. Both of the critical depth lines will coincide since the flow rate was the same for both plans. For the water surface profiles, the lines are labeled "WS 100yr - Energy" and "WS 100yr - Pressure" for the energy and pressure methods respectively.

(Note: For this example, each plan only had one profile.) Similarly, the legend description for the solid water surface profile signifies that this line is for the first profile of the energy plan.

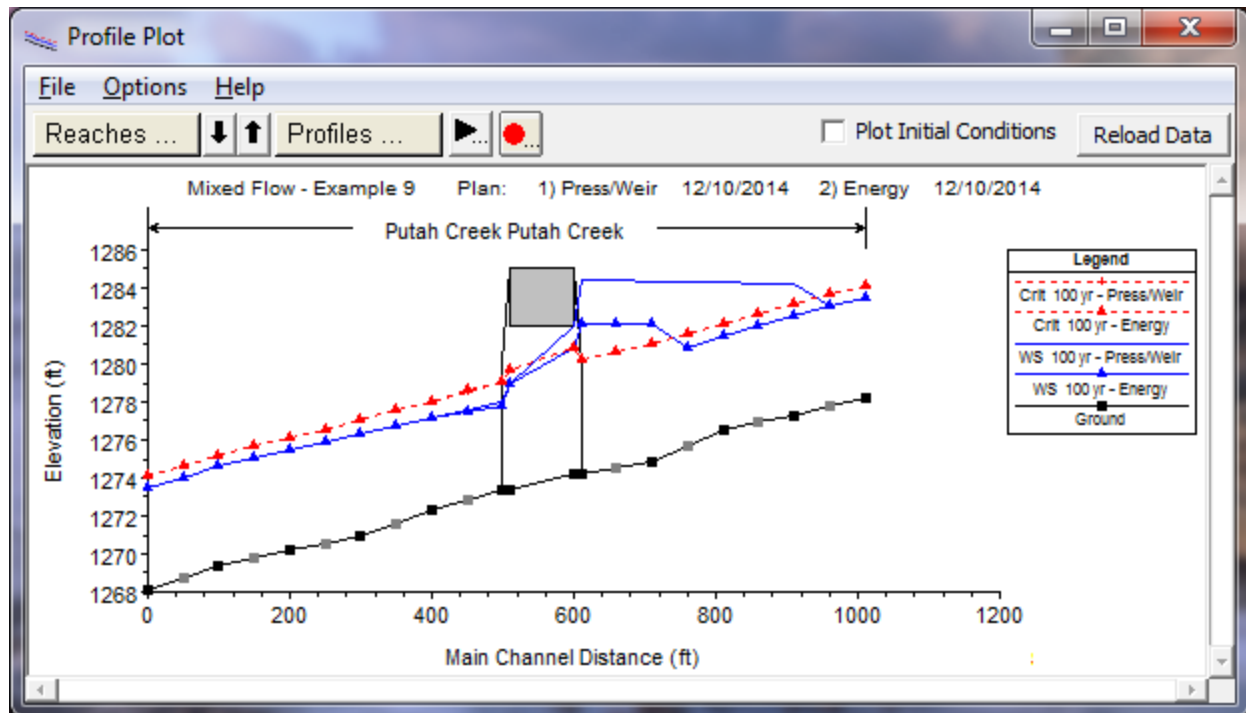

Figure 9-22: Water Surface profiles for both Energy and Pressure Analysis

A review of Figure 9.22 shows a significant difference in the calculated water surface profiles for the two plans. During the energy analysis, the water surface does not encounter the bridge decking and this lead to a low flow profile. However, the pressure analysis determined that the water surface came in contact with the upstream side of the bridge. With both of these analyses, the modeler must use engineering judgment to determine which profile is actually occurring.

Realistically, for this example, as the flow rate begins to increase to the value of 3200 cfs, the flow will most likely be a low flow profile as calculated by the energy method. At the flow rate of 3200 cfs, the flow may also initially be occurring as the low flow profile. However, the water surface immediately upstream of the bridge has risen due to the constriction of the cross sections in the vicinity of the bridge. If the flow is sediment laden and as debris begins to accumulate in the vicinity of the bridge opening, the water surface may begin to fluctuate due to the turbulent nature of the flow. These water surface fluctuations may become great enough to cause the water surface to come in contact with the upstream low cord of the bridge. When this occurs, the flow may “jump” to become pressure flow through the bridge opening.



## CHAPTER 10

# Stream Junction

### Purpose

This example was performed to demonstrate the analysis of a stream junction. The program can analyze 12 different types of junctions. These 12 types of problems are obtained by combining the 3 flow regimes (subcritical, supercritical, and mixed) with the 2 geometric configurations (combining or splitting) and the 2 analysis methods (energy and momentum). For this example, a subcritical flow combining junction was analyzed using both the energy and the momentum methods.

The discussion of this example will focus on the analysis of the stream junction. The modeler is referred to chapter 4 of the **Hydraulic Reference Manual** for additional discussion on modeling stream junctions. For looped networks, the modeler is referred to example 8.

To review the data files for this example, from the main HEC-RAS window, select **File** and then **Open Project**. Go to the directory in which you have installed the HEC-RAS example data sets. From the "Applications Guide\Chapter 10 – Stream Junction" subdirectory, select the project labeled "Stream Junction - Example 10." This will open the project and activate the following files:

Plan:	"Junction - Energy"
Geometry:	"Base Geometry - Energy Junction"
Flow:	"10 Year Profile"

### Geometric Data

The geometric data for this example consists of the river system schematic, the cross section placement, the cross section data, and the stream junction data. Each of these components are discussed below.

#### River System Schematic

To view the river system schematic, from the main program window select **Edit** and then **Geometric Data**. This will activate the **Geometric Data Editor** and display the river system schematic as shown in Figure 10.1. The schematic shows the layout of the two rivers (Spring Creek and Spruce Creek) broken into three reaches: Upper Reach, Lower Reach, and Spruce Creek. The Upper and Lower Reach of Spring Creek are divided at the junction with Spruce Creek. This junction occurs at the city of Pottsville.

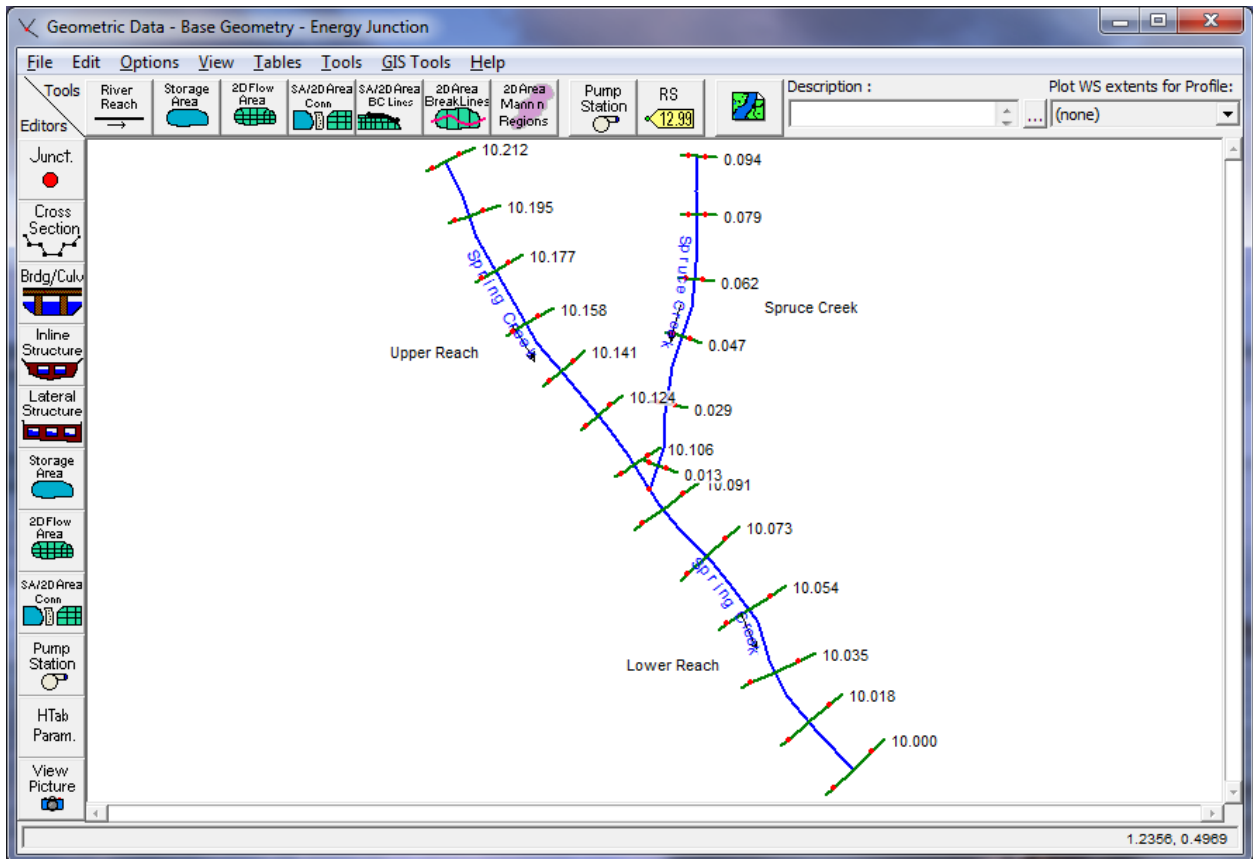

Figure 10-1: River System Schematic

To create the river system schematic, the **River Reach** icon was selected and a line was drawn in the downstream direction. Then, the program requested the name of the **river and reach**. The titles “Spring Creek” and “Upper Reach” were entered respectively. Then the River Reach icon was selected again and the “Lower Reach” was sketched. The program requested titles for this river reach and then prompted for a title of the stream junction. The name “Pottsville” was entered for the stream junction title. Finally, the River **Reach** icon was selected a third time and the Spruce Creek tributary was drawn and labeled. This created the river system schematic as shown in Figure 10.1 (without the river stations). The cross section data for the river stations were entered next and are described subsequently.

### Cross Section Placement

The location of the cross sections in relation to the stream junction are crucial for an accurate calculation of the energy losses and the water surface across the junction. There are three criteria that can be used as guidelines for the placement of the cross sections. First, the cross sections should be placed close to the stream junction. This will allow for a more accurate evaluation of the energy losses when performing an energy analysis. For a momentum analysis, the program assumes that the water surface at the two upstream

sections of the junction are equal. Therefore, to minimize the error associated with this assumption, the cross sections should be closely spaced around the junction.

The second criterion is that the data used for the cross sections does not overlap. The cross section data is acquired from a line perpendicular to the flow lines. If these lines of cross-section data intersect upstream of the junction, then the flow area may be accounted for twice and produce incorrect results. As shown in the schematic in Figure 10.2, the cross sections 7 and 1 for the Upper Reach and Spruce Creek would not be portraying accurate flow cross section data. Part of the flow area would be accounted for twice and, additionally, the cross sections would not contain the flow in the overbank areas. The cross sections numbered 8 and 2 would more accurately portray the flow situation because they do not intersect and the entire flow area is contained within the cross section data.

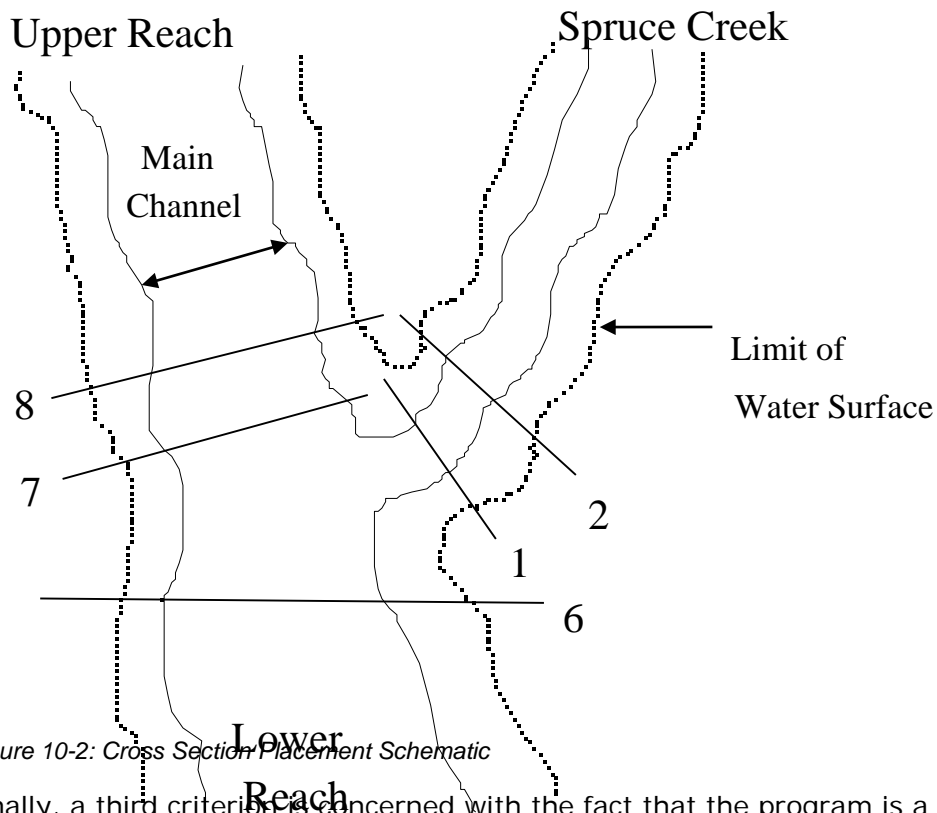

Figure 10-2: Cross Section Placement Schematic

Finally, a third criterion is concerned with the fact that the program is a one-dimensional model. Therefore, the cross sections should be located in regions where the flow direction is perpendicular to the section. For example, as shown in Figure 10.2, the cross section number 6 should be placed adequately downstream from the junction so that the flow is predominately in the downstream direction. This cross section should not be placed in the junction where the turbulent mixing of the flow is occurring. However, as discussed previously, the cross sections should be placed close to the stream junction to accurately evaluate the energy losses across the junction and to provide a reasonable result for the momentum method, which equates the two upstream water surface elevations. Observations of water surface elevations at high flows can assist the modeler in determining the appropriate locations for the cross sections.

### Cross Section Data

To enter the cross section data, from the **Geometric Data Editor** select the **Cross Section** icon on the left side of the window. This will activate the **Cross Section Data Editor** as shown in Figure 10.3. Cross section data were entered for each of the three river reaches for this example. The top portion of the editor shows the river, reach and the river station. The river stations correspond to the river miles of the specific river reach. Additionally, a description was entered for each river station.

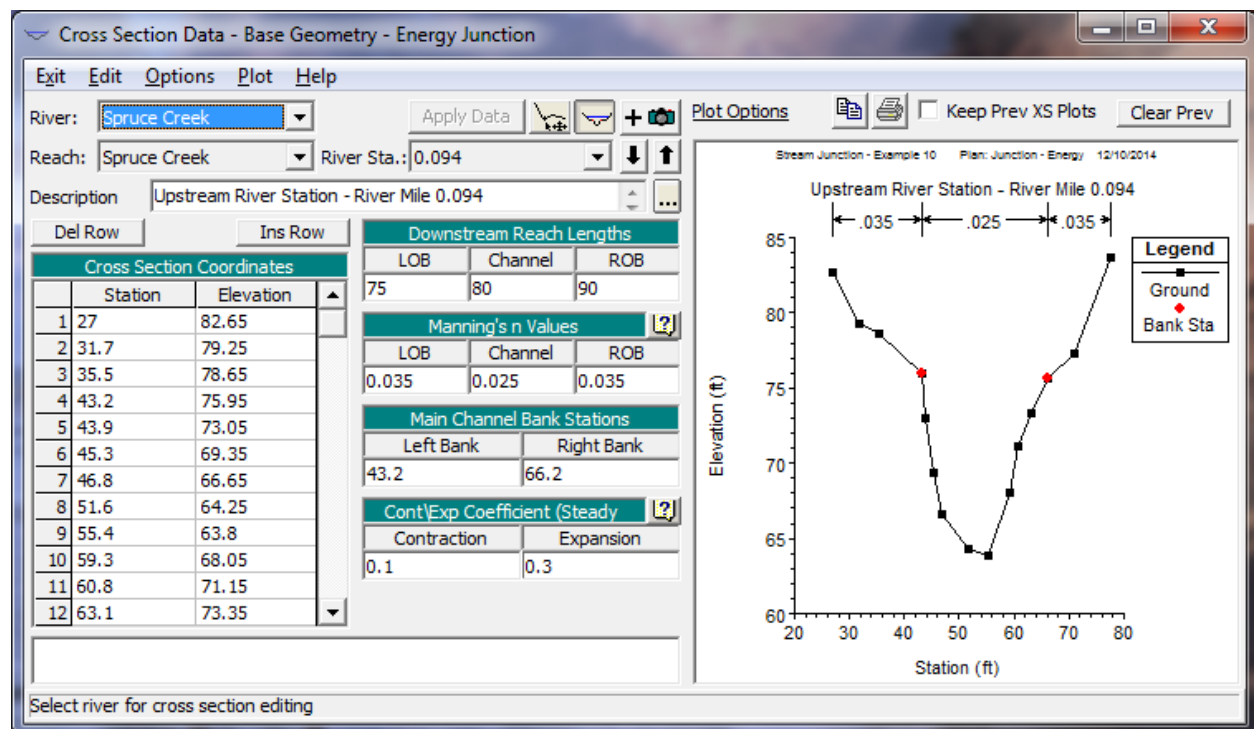

Figure 10-3: Cross Section Data Editor

The left side of the editor is where the station and elevation data for the cross section coordinates were entered. The right side of the editor displays the entered values for the downstream reach lengths, Manning's n values, main channel bank stations, and the contraction and expansion coefficients. The downstream reach lengths for the last cross section of each river reach should be set at zero or left blank. Therefore, for this example, the downstream reach lengths at the river stations of 10.106, 10.000, and 0.013 for Upper Reach, Lower Reach, and Spruce Creek, respectively, were set at 0.

Finally, any levees, ineffective flow areas, blocked obstructions, etc. would be entered at this time. For this example, the flow and cross sectional data did not provide for the use of any of these options.

### Stream Junction Data - Energy Method

The final component of the geometric data for this example is the stream junction data. To enter the junction data, from the **Geometric Data Editor** select the **Junction** icon on the left side of the window. This will activate the **Junction Data Editor** as shown in Figure 10.4.

**Junction Data - Base Geometry - Energy Junction**

Junction Name:

Description:  

Length across Junction	Junction Length (ft)	Tributary Angle (Deg)
From: Spring Creek - Lower Reach		
To: Spring Creek - Upper Reach	80	
To: Spruce Creek - Spruce Creek	70	

Steady Flow Computation Mode  
 Energy  
 Momentum  
 Add Friction  
 Add Weight

Unsteady Flow Computation Mode  
 Force Equal WS Elevations  
 Energy Balance Method

Select Junction to Edit

Figure 10-4: Junction Data Editor for Energy Method

To enter the stream junction data, first one of the stream junctions was selected by depressing the down arrow adjacent to the **Junction Name** box. For this example, there was only one junction, which had been named "Pottsville" and this junction name automatically appeared. Next, a description for the junction was entered. The entire description can be viewed by selecting the "...". The "... button can then be re-selected to exit the description display.

The next item of information required is the stream lengths across the junction. The table at the bottom left side of the editor will automatically display the names of the river reaches at the junction for which the user must enter the reach lengths. For this example, a reach length of 80 feet was entered as the distance across the junction from Upper Reach to Lower Reach. The program will then use this distance of 80 feet as the length from river station 10.106 (the downstream river station of Upper Reach) to river station 10.091 (the upstream river station of Lower Reach). Similarly, a distance of 70 feet was entered as the length across the junction from the upstream river station on Lower Reach (10.091) to the downstream river station on Spruce Creek (0.013).

The last item for the **Junction Data Editor** is the **Steady Flow Computation Mode**. The user must select either the energy or the momentum method for the steady flow computational procedure. For this example, the energy method was selected. After the discussion of the output for the energy method analysis, the momentum method will be selected and the results from the two methods will be compared. A discussion on the computational procedures for each method will be addressed during the review of the output for each method.

The selection of the energy method for the junction analysis completed the geometric input for this example. The junction editor was then closed by selecting the **OK** button. Finally, the geometric data was then saved by selecting **File** and then **Save Geometric Data As** from the **Geometric Data Editor**. The title "Base Geometry - Energy Junction" was entered for the name of the file. The next procedure was to enter the steady flow data.

## **Steady Flow Data**

To enter the steady flow data, from the main program window select **Edit** and then **Steady Flow Data**. This will activate the **Steady Flow Data Editor** as shown in Figure 10.5. For this example, the number of profiles was selected as one. When this number was entered, the table for the steady flow data adjusted to account for the number of profiles that were selected.

Next, the flow values were entered. The user must enter a flow value at the upstream end of each river reach and the table for the flow data will automatically display the upstream river stations for each river reach. The values of 1100, 3000, and 4100 were then entered as the flow values at the upstream river stations for Spruce Creek, Upper Reach, and Lower Reach, respectively.

After the steady flow values were entered, the boundary conditions were then assigned. This was performed by selecting the **Boundary Conditions** icon at the top of the window. This activated the **Boundary Conditions Data Editor** as shown in Figure 10.6. As shown in the figure, a table is displayed that lists all of the river reaches. The table will automatically display any internal boundary conditions such as stream junctions. These internal boundary conditions are based upon how the river system was defined by the geometric data. The user can then enter any external boundary condition for each river reach.

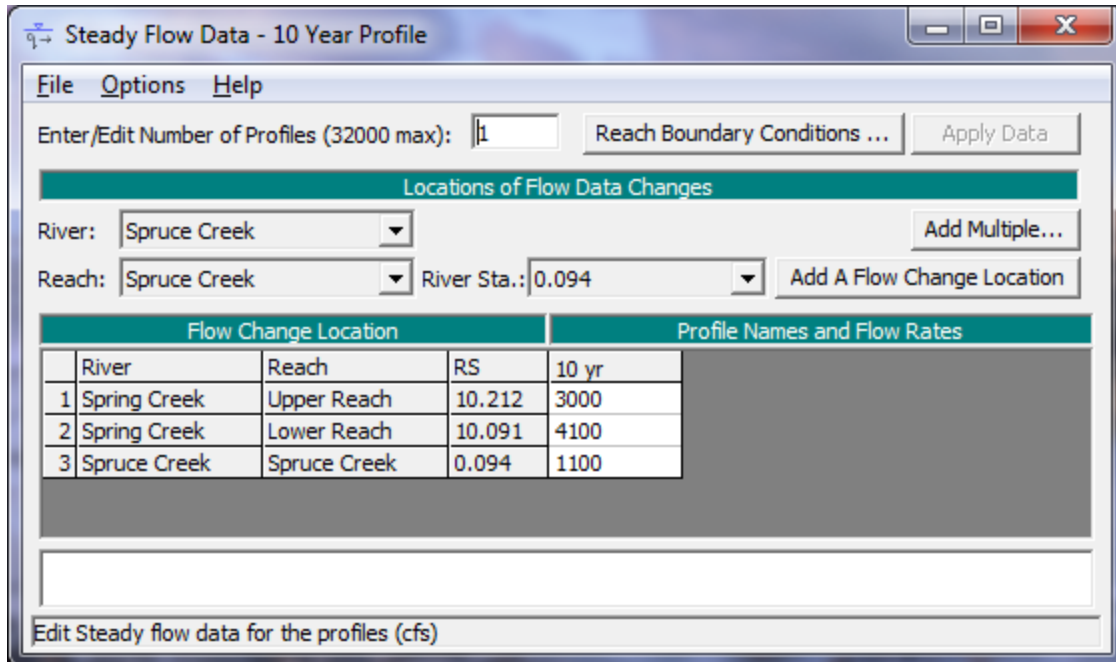

Figure 10-5: Steady Flow Data Editor

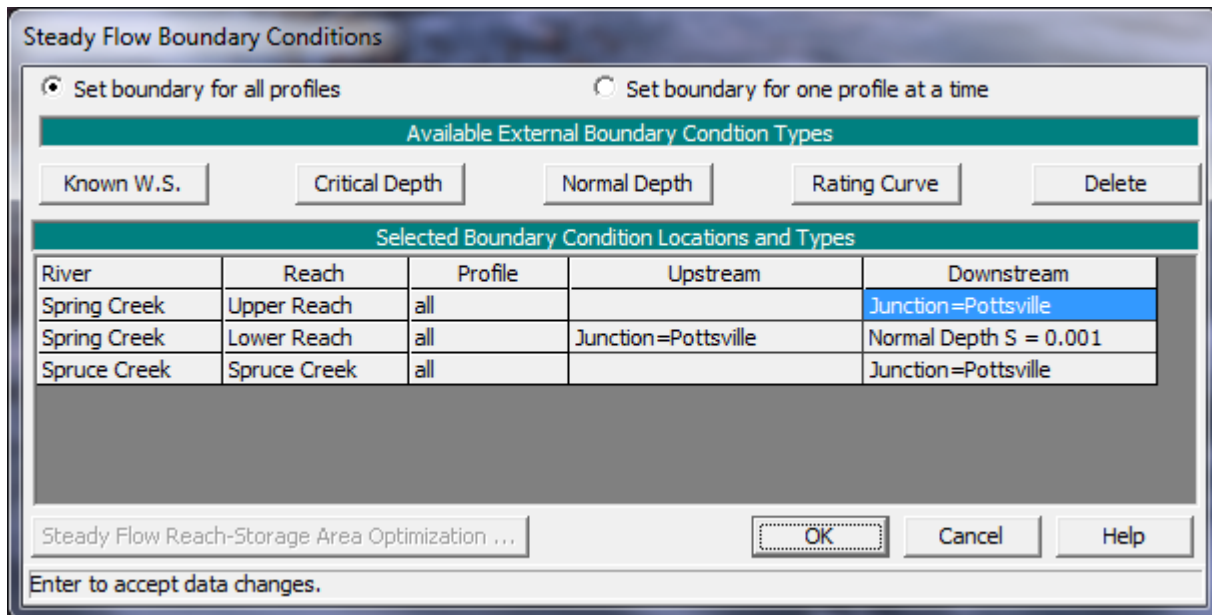

Figure 10-6: Boundary Conditions Data Editor

For this example, a subcritical analysis was performed and therefore a downstream boundary condition was required to be entered for the Lower Reach of Spring Creek. To enter this boundary condition, the downstream field for Lower Reach was selected and then the boundary condition **Normal Depth** was chosen. A slope of 0.001 was then entered for this boundary condition. For a further discussion on boundary conditions, the user is referred to chapter 7 of the **User's Manual** and to chapter 3 of the **Hydraulic Reference Manual**.

After all of the steady flow data had been entered, the steady flow data file was then saved by selecting **File** and then **Save Steady Flow Data As** from

the **Steady Flow Data Editor**. The title "10 Year Profile" was then entered and the **OK** button selected.

## Steady Flow Analysis (Stream Junction Energy Method)

After the flow data were entered, the steady flow data file and the geometry file were saved as a plan. This was performed by first selecting **Run** and then **Steady Flow Analysis** from the main program window. This activated the **Steady Flow Analysis Window** as shown in Figure 10.7.

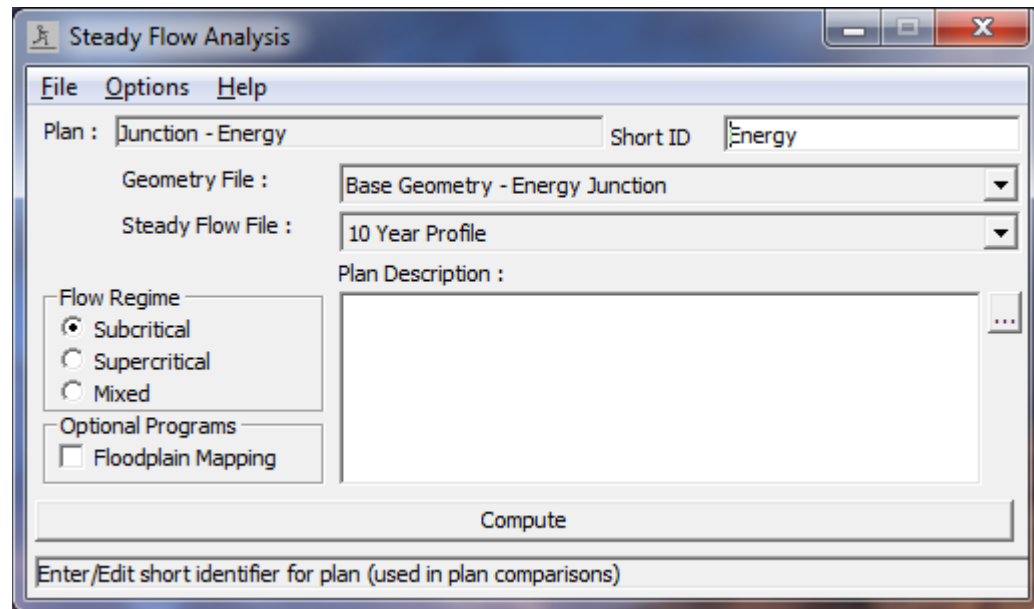

Figure 10-7: Steady Flow Analysis Window

At the top of the **Steady Flow Analysis Window**, a **Short ID** was entered as "Energy." The next step was to select the appropriate flow regime for the analysis. For this example, the Subcritical regime was selected. Then, the geometry file "Base Geometry - Energy Junction" and the steady flow file "10 Year Profile" were selected by depressing the down arrows on the right side of the window. (Note: At this point in the example, there was only one geometry and one flow file. Therefore, this step was not necessary.) To save these files as a plan, select **File** and then **Save Plan As**. The title "Junction - Energy" was then entered as the plan title and the **OK** button was selected. This associated the geometry and the steady flow file as a plan and the name of the plan then appeared on the **Steady Flow Analysis Window** (as well as on the main program window). Finally, the **COMPUTE** button was selected to perform the analysis.

## Review of Output for Stream Junction Energy Analysis

To review the output for the analysis, the user can evaluate the data in both graphical and tabular format. For this example, the water surface profile and the standard table 2 profile table will be reviewed.



## Water Surface Profile

To view the water surface profiles for the analysis, from the main program window select **View** and then **Water Surface Profiles**. This will activate the profile plot as shown in Figure 10.8. The profile in Figure 10.8 displays the energy gradeline, the water surface elevation, and the critical depth line for the reaches of Upper Reach and Lower Reach. From the figure, it can be seen that the flow regime is subcritical because the water surface profile is above the critical depth line. Additionally, the energy gradeline displays a constant increase in energy in the upstream direction. Abrupt changes in the water surface profile or the energy gradeline should prompt the user to closely examine the flow situation at these locations.

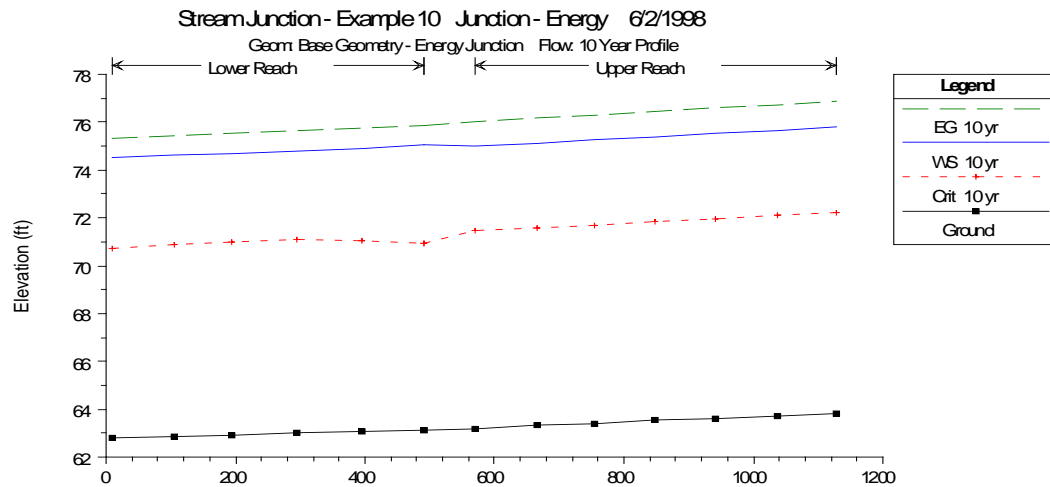

Figure 10-8: Water Surface Profile for Energy Junction

At this time, the user can select which reaches to be displayed by selecting **Options** and then **Reaches**. In this manner, the water surface profile for the combination of Spruce Creek and Lower Reach can be viewed. The user can also select to have all three reaches displayed simultaneously.

To determine the water surface profile across the stream junction, the program used the energy based solution routine for this plan. Since this was a subcritical flow analysis, the program started the calculations at the downstream end of the Lower Reach and computed the water surface profile up to the upstream river station of Lower Reach (10.091). Then the program performed standard step calculations separately across the stream junction to each of the downstream river stations of Upper Reach and Spruce Creek. During each of the separate calculations, the friction losses and the contraction and expansion losses were calculated to balance the energy from river station 10.091 to each of the river stations 10.106 and 0.013 of Upper Reach and Spruce Creek, respectively. By performing the calculations in this manner, the downstream water surface elevations of Upper Reach and Spruce Creek do not necessarily have to coincide.

## Standard Table 2

As a further review of the output, from the main program window select **View** and then **Profile Summary Table**. Then select **Std. Tables** and then **Standard Table 2**. This will result in the display as shown in Figure 10.9.

### Example 10 Stream Junction

The first two columns in the table are in fixed format and display the river reach and the river stationing. The columns in the non-fixed area of the table (as shown in Figure 10.9) display the energy gradeline, the water surface elevation, the velocity head, the friction losses, and the contraction/expansion losses. The remaining portion of the table can be viewed by depressing the left and right arrows at the bottom of the window.

The table in Figure 10.9 can be reviewed to follow the standard step computations across the stream junction. The energy gradeline elevation for the upstream river station of Lower Reach (10.091) was 75.88 ft. When calculating the energy losses across the stream junction from river station 10.091 to 10.106 (the downstream river station of Upper Reach), the program determined that the friction loss was 0.09 feet and the contraction/expansion loss was 0.06 feet. These values are displayed in the row for the Upper Reach station of 10.106. By summing these losses, a total energy loss of  $0.09 + 0.06 = 0.15$  feet is obtained. Then, this 0.15 feet of energy was added to the energy of 75.88 feet to obtain an energy value of  $0.15 + 75.88 = 76.03$  feet at river station 10.106. (Note: The table only displayed the values to two decimal places and rounding of numerical values occurred.) The standard step procedure was then continued upstream through the reach of Upper Reach.

The screenshot shows a window titled "Profile Output Table - Standard Table 2" with a menu bar (File, Options, Std. Tables, User Tables, Locations, Help) and a toolbar (Reload Data). The table header is "HEC-RAS Plan: Energy Profile: 10 yr". The table contains 24 rows of data for two creeks: Spruce Creek and Spring Creek. The columns are: River, Reach, River Sta, Profile, E.G. Elev (ft), W.S. Elev (ft), Vel Head (ft), Frctn Loss (ft), C & E Loss (ft), Q Left (cfs), Q Channel (cfs), and Q Right (cfs). The data shows a transition from Lower Reach to Upper Reach for both creeks, with energy values and losses calculated at various river stations.

River	Reach	River Sta	Profile	E.G. Elev (ft)	W.S. Elev (ft)	Vel Head (ft)	Frctn Loss (ft)	C & E Loss (ft)	Q Left (cfs)	Q Channel (cfs)	Q Right (cfs)
Spruce Creek	Spruce Creek	0.094	10 yr	76.51	75.90	0.61	0.10	0.01		1099.97	0.03
Spruce Creek	Spruce Creek	0.079	10 yr	76.40	75.81	0.59	0.11	0.01	0.00	1099.96	0.04
Spruce Creek	Spruce Creek	0.062	10 yr	76.29	75.72	0.57	0.09	0.01	0.01	1099.94	0.05
Spruce Creek	Spruce Creek	0.047	10 yr	76.19	75.63	0.55	0.11	0.01	0.03	1099.91	0.06
Spruce Creek	Spruce Creek	0.029	10 yr	76.08	75.54	0.54	0.09	0.01	0.07	1099.86	0.07
Spruce Creek	Spruce Creek	0.013	10 yr	75.98	75.46	0.52	0.07	0.03	0.14	1099.78	0.08
Spring Creek	Upper Reach	10.212	10 yr	76.89	75.78	1.10	0.14	0.00		3000.00	
Spring Creek	Upper Reach	10.195	10 yr	76.74	75.65	1.09	0.14	0.00		3000.00	
Spring Creek	Upper Reach	10.177	10 yr	76.60	75.51	1.08	0.14	0.00		3000.00	
Spring Creek	Upper Reach	10.158	10 yr	76.45	75.38	1.08	0.14	0.00		3000.00	
Spring Creek	Upper Reach	10.141	10 yr	76.31	75.25	1.06	0.13	0.00		3000.00	
Spring Creek	Upper Reach	10.124	10 yr	76.18	75.12	1.06	0.14	0.00		3000.00	
Spring Creek	Upper Reach	10.106	10 yr	76.03	74.99	1.05	0.09	0.06		3000.00	
Spring Creek	Lower Reach	10.091	10 yr	75.88	75.04	0.84	0.10	0.00		4100.00	
Spring Creek	Lower Reach	10.073	10 yr	75.78	74.92	0.86	0.11	0.00		4100.00	
Spring Creek	Lower Reach	10.054	10 yr	75.67	74.80	0.87	0.11	0.00		4100.00	
Spring Creek	Lower Reach	10.035	10 yr	75.56	74.70	0.86	0.10	0.01		4100.00	
Spring Creek	Lower Reach	10.018	10 yr	75.45	74.62	0.83	0.10	0.01		4100.00	
Spring Creek	Lower Reach	10.000	10 yr	75.34	74.55	0.80				4100.00	

Energy gradeline for given WSEL.

Figure 10-9: Profile Standard Table 2 for Energy Junction Analysis

Similarly, the user can toggle the table to display the information for Spruce Creek and follow the same procedure to determine the energy losses across the junction from the upstream river station of Lower Reach to the downstream river station of Spruce Creek. (Note: If the table does not

display the information for all of the river reaches, the user can select the appropriate reaches for display under the **Options** menu.)

## Steady Flow Analysis (Stream Junction Momentum Method)

After the energy method was used to analyze the stream junction, the computation procedure was changed to the momentum method. This was performed by opening the **Geometric Data Editor** and selecting the **Junction** icon on the left side of the window. This will activate the **Junction Data Editor** as shown in Figure 10.10.

The components of **Junction Name**, **Description**, and **Reach Lengths** were kept the same as described for the energy method analysis. However, the **Steady Flow Computation Mode** was selected as *Momentum* for the subsequent analysis. For the momentum method, the user must enter the angles at which the reaches are entering or leaving the junction. For a flow combining situation (such as this example), the user must enter the angles of the inflow reaches as measured from a line perpendicular to the upstream cross section of the outflow reach. (Note: Figure 4.9 in the **Hydraulic Reference Manual** will assist the user to visualize the flow angles.)

Length across Junction	Junction Length (ft)	Tributary Angle (Deg)
From: Spring Creek - Lower Reach		
To: Spring Creek - Upper Reach	80	
To: Spruce Creek - Spruce Creek	70	45

Figure 10-10: Junction Data Editor for Momentum Method

For this example, the tributary angle from Upper Reach to Lower Reach was entered as 0 degrees. This implies that the flow will continue in a straight line. The flow angle from Spruce Creek to Lower Reach was then entered as 45 degrees, as measured from the survey data.

Finally, the user must select whether the program should include the weight and/or the friction terms in the momentum equation. For this example, the terms were included by selecting the appropriate boxes in the lower right corner of the window. The user should refer to chapter 4 of the **Hydraulic Reference Manual** for a further discussion of the momentum equations.

After these changes were made, the **Apply Data** button was selected and the junction editor was closed. Since this geometry file was changed, it was then saved as a new file. This was performed by selecting **File** and then **Save Geometry As**. The title "Base Geometry - Momentum Junction" was entered and the **OK** button selected. Then the **Geometric Data Editor** was closed.

From the main program window, **Run** and then **Steady Flow Analysis** were then selected. This activated the **Steady Flow Analysis Window** as shown in Figure 10.11.

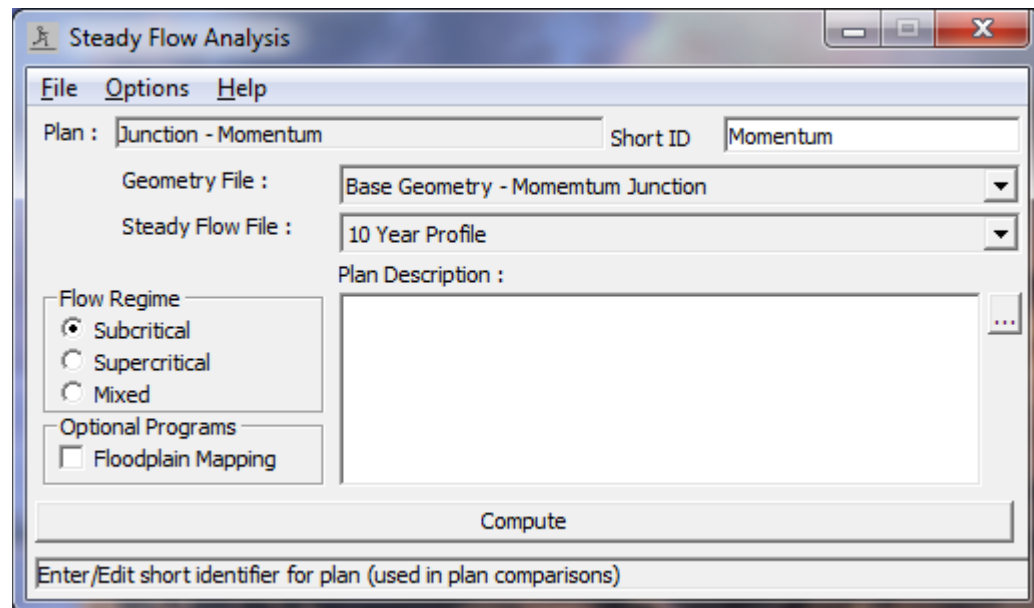

Figure 10-11: Steady Flow Analysis Window for Momentum Method

In the upper right corner of the window, a **Short ID** was entered as "Momentum." Then, the geometry file "Base Geometry - Momentum Junction" and the flow file "10 Year Profile" were selected by depressing the down arrows on the right side of the window. Next, the **Flow Regime** was selected as *Subcritical*. Then, **File** and **Save Plan As** were selected and the title "Junction - Momentum" was entered. This plan title then appeared at the top of the window (as well as on the main program window). Finally, the **COMPUTE** button was selected to perform the analysis.

## Review of Output for Stream Junction Momentum Analysis

To review the output for the analysis, the user can evaluate the data in both graphical and tabular format. For this example, the water surface profile and the standard table 2 profile table will be reviewed.

### Water Surface Profile

To view the water surface profiles for the analysis, from the main program window select **View** and then **Water Surface Profiles**. This will activate the profile plot as shown in Figure 10.12.

The profile plot shown in Figure 10.12 is similar to the plot as shown in Figure 10.8, except Figure 10.12 is for the results of the momentum analysis of the stream junction. Figure 10.12 shows the energy gradeline, the water surface elevation, and the critical depth line. The profile is seen to be occurring in the subcritical flow regime. As discussed previously, the user can select other reaches to display the corresponding water surface profiles.

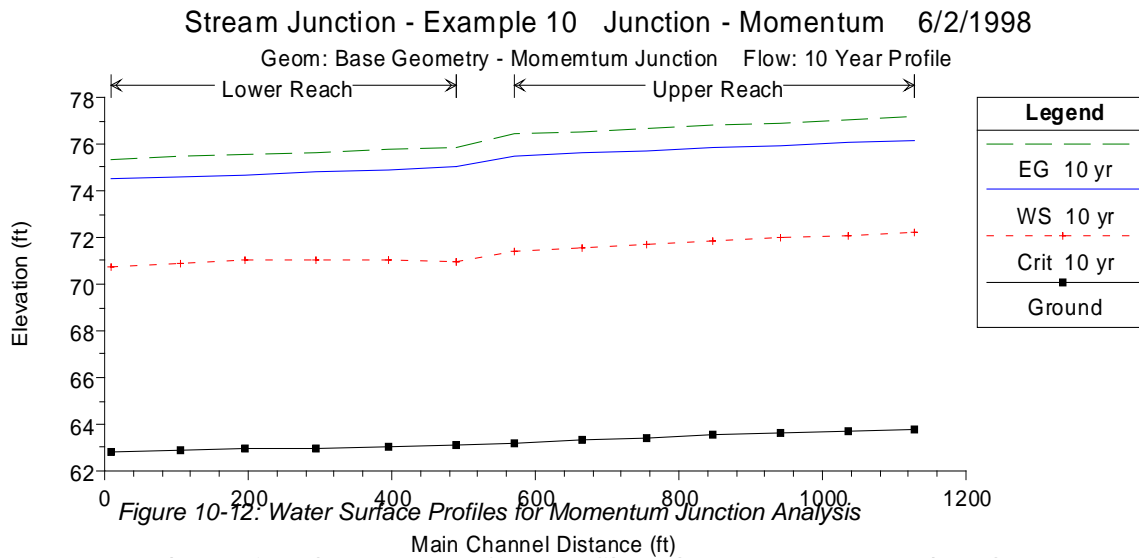

To determine the water surface profiles, the program started at the downstream end of the Lower Reach (since this was a subcritical flow analysis) and used the standard step procedure up to the upstream end of Lower Reach. At the stream junction, the program then used the momentum method to balance the forces across the junction. The momentum method (for this example) will solve simultaneously the forces in the X-direction for the flow at river stations 10.091 (the upstream river station of Lower River), 10.106 (the downstream river station of Upper Reach), and 0.013 (the downstream river station of Spruce Creek). The X-direction is determined as the direction of the flow out of the junction (the direction of flow at river station 10.091).

Since the water surface elevations at the downstream ends of Upper Reach and Spruce Creek are two unknown values and are solved simultaneously, the program will assume that these water surface elevations are equal to each other. Therefore, it is necessary that the cross sections be placed close to the stream junction in order to minimize the error associated with this assumption. For a more detailed discussion on the momentum method analysis, the user is referred to chapter 4 of the **Hydraulic Reference Manual**.

### Standard Table 2

As a further review of the output, from the main program window select View and then Profile Table. Then select Std. Tables and then Standard Table 2. This will result in the display as shown in Figure 10.13. As discussed previously, the first two columns in the table are in fixed format and display the river reach and the river stationing. (Note: For this table, all 3 river reaches were selected to be displayed.) The columns in the non-fixed area of the table display the energy gradeline, the water surface elevation, the velocity head, the friction losses, and the contraction/expansion losses. The remaining portion of the table can be viewed by depressing the left and right arrows at the bottom of the window.

As shown in Figure 10.13, the water surface elevations for Lower Reach are exactly the same values in the previous run because nothing has changed in

## Example 10 Stream Junction

the downstream reach. However, for this plan, the water surface elevations across the stream junction were determined using the momentum method. As discussed previously, to perform the momentum calculations at the stream junction, the program will equate the two upstream water surface elevations. This is seen to have occurred as the water surface elevations at river station 10.106 (the downstream station of Upper Reach) and river station 0.013 (the downstream river station of Spruce Creek) are both equal to 75.50 feet. Then, the program determined separately the remaining water surface profiles for Upper Reach and Spruce Creek by using the standard step procedure in the upstream direction.

River	Reach	River Sta	Profile	E.G. Elev (ft)	W.S. Elev (ft)	Vel Head (ft)	Frctn Loss (ft)	C & E Loss (ft)	Q Left (cfs)	Q Channel (cfs)	Q Right (cfs)
Spruce Creek	Spruce Creek	0.094	10 yr	76.54	75.93	0.60	0.10	0.01		1099.95	0.05
Spruce Creek	Spruce Creek	0.079	10 yr	76.43	75.84	0.58	0.11	0.01	0.00	1099.94	0.06
Spruce Creek	Spruce Creek	0.062	10 yr	76.32	75.75	0.57	0.09	0.01	0.01	1099.92	0.06
Spruce Creek	Spruce Creek	0.047	10 yr	76.22	75.67	0.55	0.10	0.01	0.04	1099.88	0.08
Spruce Creek	Spruce Creek	0.029	10 yr	76.11	75.58	0.53	0.09	0.01	0.09	1099.82	0.09
Spruce Creek	Spruce Creek	0.013	10 yr	76.02	75.50	0.51			0.17	1099.72	0.10
Spring Creek	Upper Reach	10.212	10 yr	77.18	76.17	1.01	0.12	0.00		3000.00	
Spring Creek	Upper Reach	10.195	10 yr	77.05	76.05	0.99	0.12	0.00		3000.00	
Spring Creek	Upper Reach	10.177	10 yr	76.92	75.94	0.98	0.12	0.00		3000.00	
Spring Creek	Upper Reach	10.158	10 yr	76.79	75.82	0.97	0.12	0.01		3000.00	
Spring Creek	Upper Reach	10.141	10 yr	76.67	75.72	0.95	0.11	0.00		3000.00	
Spring Creek	Upper Reach	10.124	10 yr	76.55	75.61	0.94	0.12	0.00		3000.00	
Spring Creek	Upper Reach	10.106	10 yr	76.43	75.50	0.93				3000.00	
Spring Creek	Lower Reach	10.091	10 yr	75.88	75.04	0.84	0.10	0.00		4100.00	
Spring Creek	Lower Reach	10.073	10 yr	75.78	74.92	0.86	0.11	0.00		4100.00	
Spring Creek	Lower Reach	10.054	10 yr	75.67	74.80	0.87	0.11	0.00		4100.00	
Spring Creek	Lower Reach	10.035	10 yr	75.56	74.70	0.86	0.10	0.01		4100.00	
Spring Creek	Lower Reach	10.018	10 yr	75.45	74.62	0.83	0.10	0.01		4100.00	
Spring Creek	Lower Reach	10.000	10 yr	75.34	74.55	0.80				4100.00	

Figure 10-13: Standard Profile Table 2 for Momentum Junction Analysis

## Comparison of Energy and Momentum Results

To compare the water surface profiles for the energy and the momentum analyses of the stream junction, the water surface profile plot was selected to view both of the plans. This was performed by selecting **View** and then **Water Surface Profiles** from the main program window. Then, under the **Options** menu, the reaches were selected as Upper Reach and Lower Reach. Finally, under the **Options** menu again, both **Plans** were selected. This resulted in the display as shown in Figure 10.14.

Figure 10.14 shows the water surface elevations for Upper Reach and Lower Reach for both methods of junction analysis. At the top of the figure, the heading lists the project name "Stream Junction - Example 10" and the short identifiers listed for each plan.

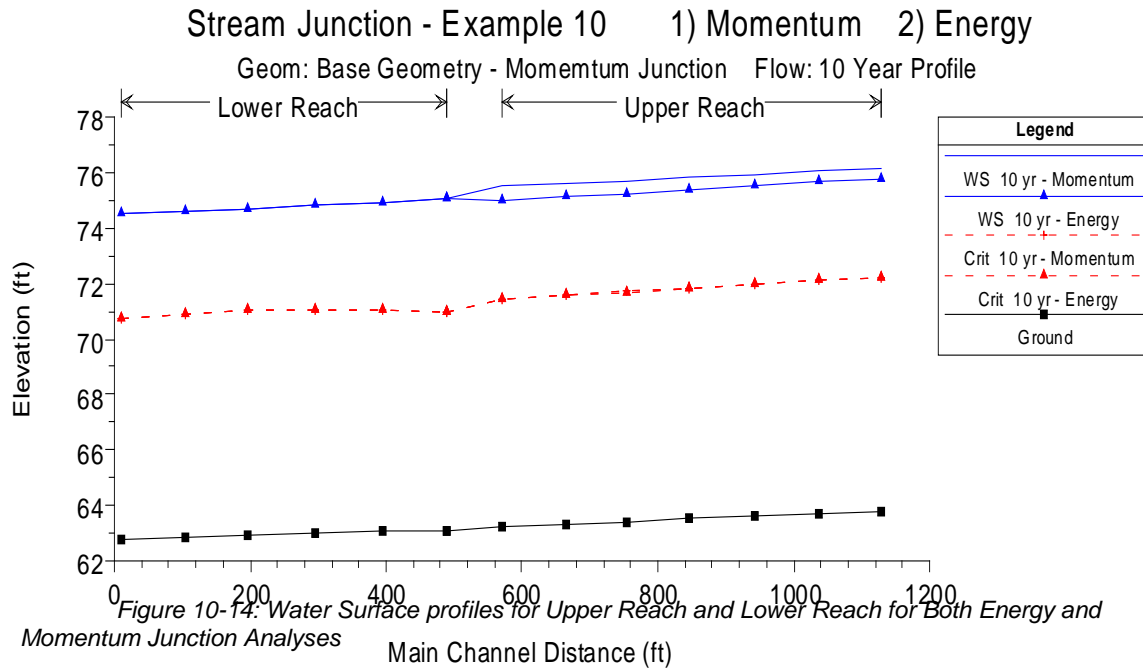

By visually comparing the two results, it can be seen that the calculated water surface profile for Lower Reach was the same for both plans. However, the water surface profile for Upper Reach was different. This is due to the fact that the starting downstream water surface elevation at river station 10.106 of Upper Reach was different, for the two methods of computation across the junction. If the standard step procedure was allowed to continue for a longer distance upstream on Upper Reach, both of the water surface profiles would eventually converge.

At this time, the user can select to view the combination of Spruce Creek and Lower Reach and observe a similar result. The profile would show that the momentum method produced a higher resulting water surface profile on Spruce Creek than the energy method. However, the difference of the water surface profiles for Spruce Creek is not as significant as that for Upper Reach.

The energy method uses friction and the coefficients of contraction and expansion in determining the energy losses across the junction. The user can adjust these coefficients to account for any abrupt transitions that occur in the cross sectional area. Additionally, the user could adjust the Manning's n value at the stream junction to account for additional internal energy losses associated with the junction. By adjusting these parameters, the calculated water surface profile can be calibrated to actual measured water surface elevations.

For the momentum method, the program determines the water surface elevations across the stream junction by taking into account the forces associated with the flow. To balance the forces across the junction, the program only uses the forces in the X-direction. This direction is determined as being perpendicular to the outflow direction (for a flow combining situation). Therefore, the tributary angles, as entered by the user, are crucial for the accurate calculation of the forces. Additionally, as for the energy

method, the Manning's n values can be adjusted to account for additional friction losses associated with the stream junction.

## **Summary**

Both the energy and the momentum methods were used to determine the water surface profiles across the stream junction. For this example, the resulting water surface profiles differed upstream of the junction for the two calculation procedures.

The energy method used the standard step procedure with the coefficients of expansion and contraction and the Manning's n value to account for energy losses across the junction. With the energy method, the program calculated separately the resulting upstream water surface elevations. The momentum method equated the forces in one dimension and used the tributary angles to balance the forces at the stream junction. Additionally, the Manning's n values are used to account for friction losses. The momentum method should be used when the tributary flow angles play an important role in influencing the water surface around the junction. However, in order to solve the momentum calculations, the upstream water surface elevations were equated. To reduce the error associated with this assumption, the cross sections should be located close to the stream junction.

The momentum method is an attempt at a more theoretical analysis of the stream junction. However, the user should be aware of the limitations of this one-dimensional analysis. To determine the most applicable method for the analysis, the user should compare the results to observed data and calibrate the model as deemed appropriate.



## CHAPTER 11

# Bridge Scour

## Purpose

This example will demonstrate the use of HEC-RAS to perform a bridge scour analysis. To perform the analysis, the user must first develop a hydraulic model of the river reach that contains the bridge. This model should be calibrated to the fullest extent possible in order to accurately determine the hydraulics of the river reach. Once this model is developed, the bridge scour computations can then be performed.

The scour computations in HEC-RAS are comprised of three components: contraction scour, pier scour, and abutment scour. The scour equations for these components are based upon the methods outlined in Hydraulic Engineering Circular No. 18 (FHWA, 1995). The program does not have the capability to perform long-term aggradation or degradation. The user must determine the long-term effects before applying the bridge scour computations in HEC-RAS. The procedures for performing long-term effects are discussed in the HEC No. 18 publication.

This example will focus upon the analysis of the bridge scour. The modeler is referred to chapter 6 of the **User's Manual** and to chapter 5 of the **Hydraulic Reference Manual** for additional discussion on modeling bridges. Additionally, the modeler is referred to chapter 12 of the **User's Manual**, chapter 10 of the **Hydraulic Reference Manual**, and to HEC No. 18 for further discussion on the scour computations.

This example is adapted from the example problem contained within the HEC No. 18 publication. To review the data files for this example, from the main HEC-RAS window, select **File** and then **Open Project**. Go to the directory in which you have installed the HEC-RAS example data sets. From the "Applications Guide\Chapter 11 – Bridge Scour" subdirectory, select the project labeled "Bridge Scour - Example 11." This will open the project and activate the following files:

Plan:	"Scour Plan 1"
Geometry:	"Base Geometry"
Flow:	"100-Year Discharge"
Hydr Design:	"Hydraulic Design Data"

## Geometric Data

To view the geometric data for the river system, from the main program window select Edit and then Geometric Data. This will activate the Geometric Data Editor and display the river system schematic as shown in

Figure 11.1. The schematic displays the nine river stations along the reach of Pine Creek, with river station 10.90 as the upstream section. The user can view the cross section data for each river station by selecting the Cross Section icon on the left side of the Geometric Data Editor.

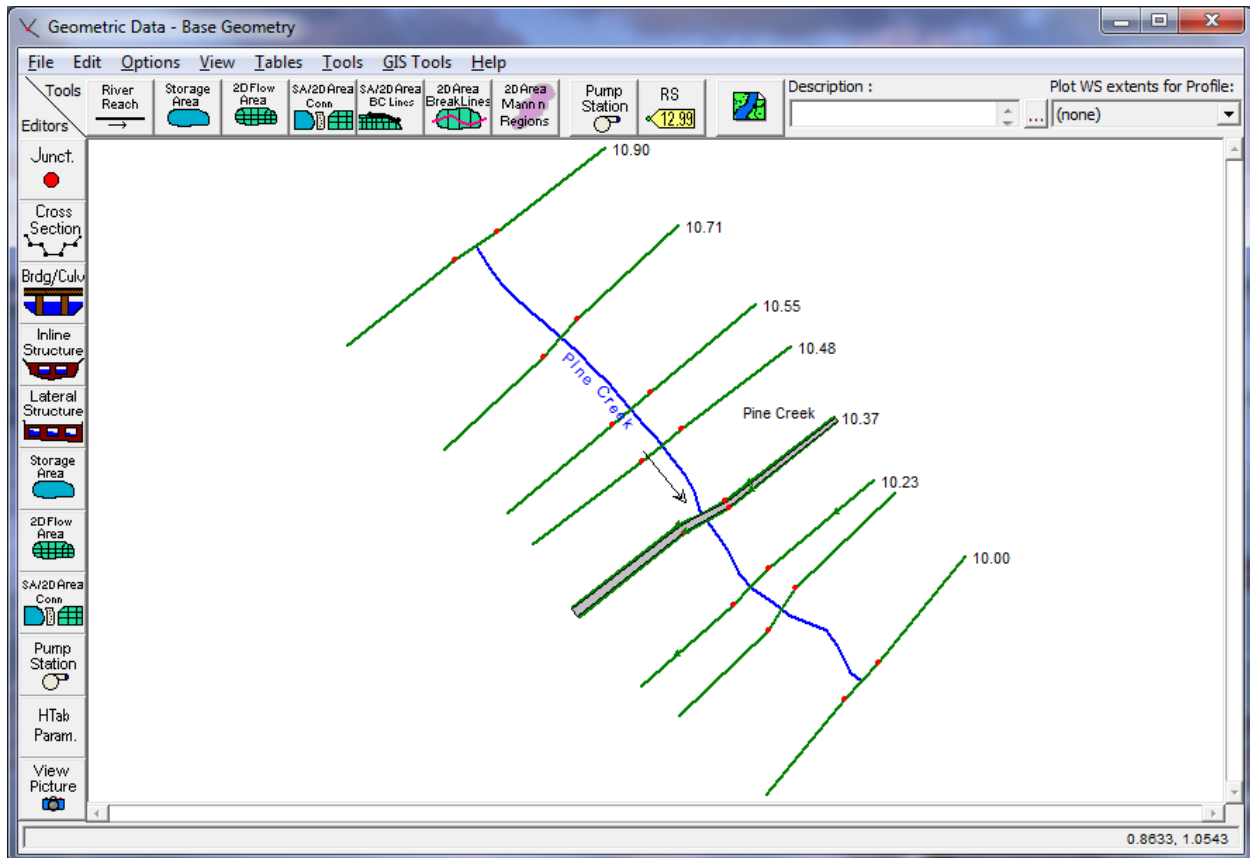

Figure 11-1: River System Schematic

Along this reach of Pine Creek, a bridge was entered at river station 10.36. The bridge data were entered by selecting the **Brdg/Culv** icon on the left side of the **Geometric Data Editor**. This activated the **Bridge/Culvert Data Editor** as shown in Figure 11.2. Then, the bridge information for the deck/roadway, piers, sloping abutments, and bridge modeling approach were entered by selecting the appropriate icons on the left side of the **Bridge/Culvert Data Editor**. The bridge opening between the sloping abutments is approximately 600 feet wide and the bridge is supported by six piers, each with a width of 5 feet. The high and low cord values for the bridge deck are 22 and 18 feet, respectively. The user can select the appropriate icons to review the bridge data.

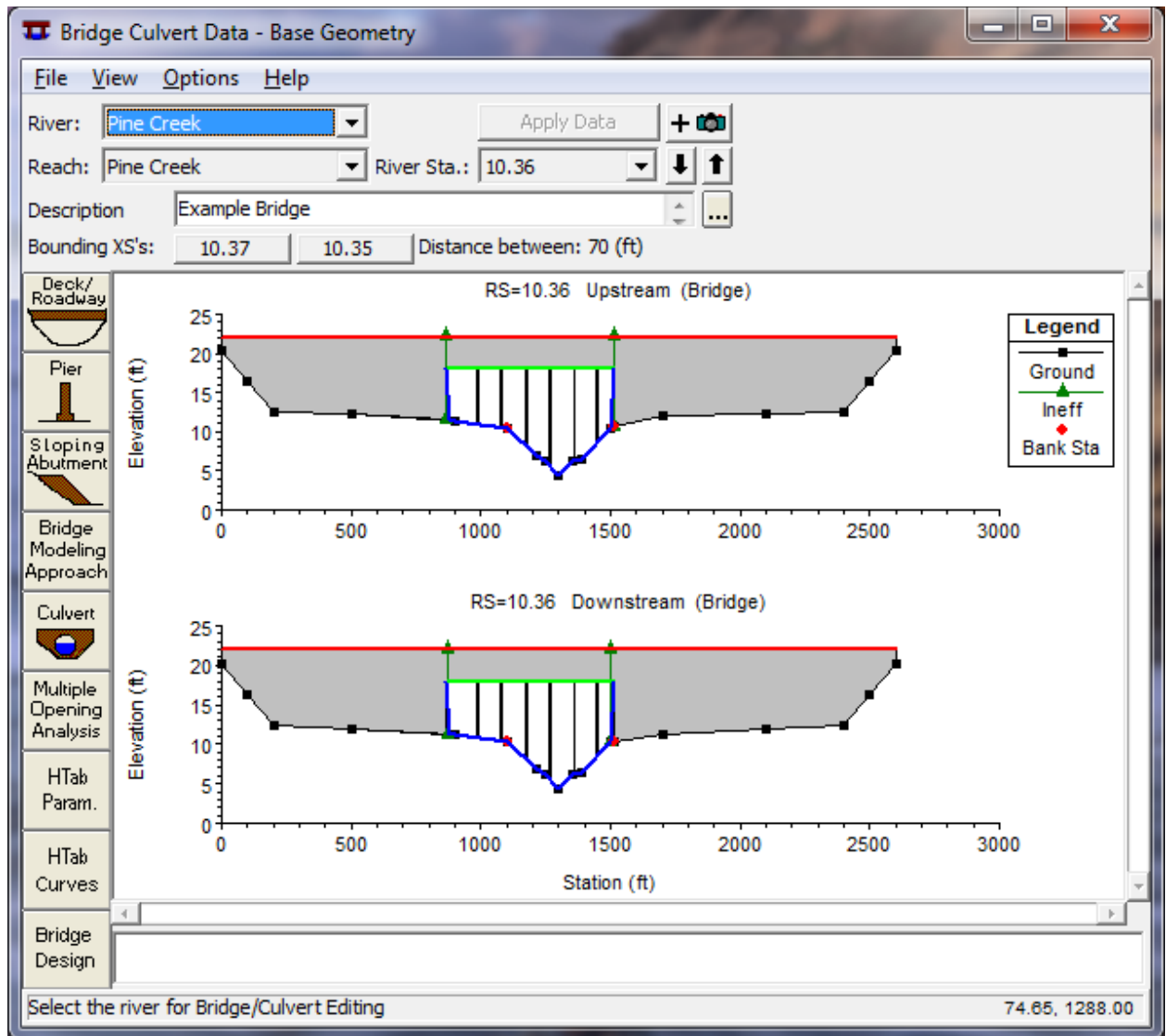

Figure 11-2: Bridge/Culvert Data Editor

After all of the geometric data had been entered, the editors were closed and the geometry was saved as “Base Geometry.” Next, the steady flow data were entered.

## Steady Flow Data

To enter the steady flow data, from the main program window **Edit** and then **Steady Flow Data** were selected. This activated the **Steady Flow Data Editor** and one profile with a flow value of 30000 cfs was entered. This flow rate represents the 1 percent chance event (100-year discharge) for the river reach. Next, a downstream boundary condition was entered as Normal Depth with a slope of 0.002 ft/ft. Then, the flow data were saved with a title of “100-Year Discharge.”

## Steady Flow Analysis

After the geometric and steady flow data were entered, the steady flow analysis was performed. First, **Run** and then **Steady Flow Analysis** were selected from the main program window. Then, a *Short ID* was entered as "Plan 01" and a subcritical analysis was selected. Next, **Options** and then **Flow Distribution Locations** were selected from the **Steady Flow Analysis Window**. This activated the **Flow Distribution Editor** as shown in Figure 11.3.

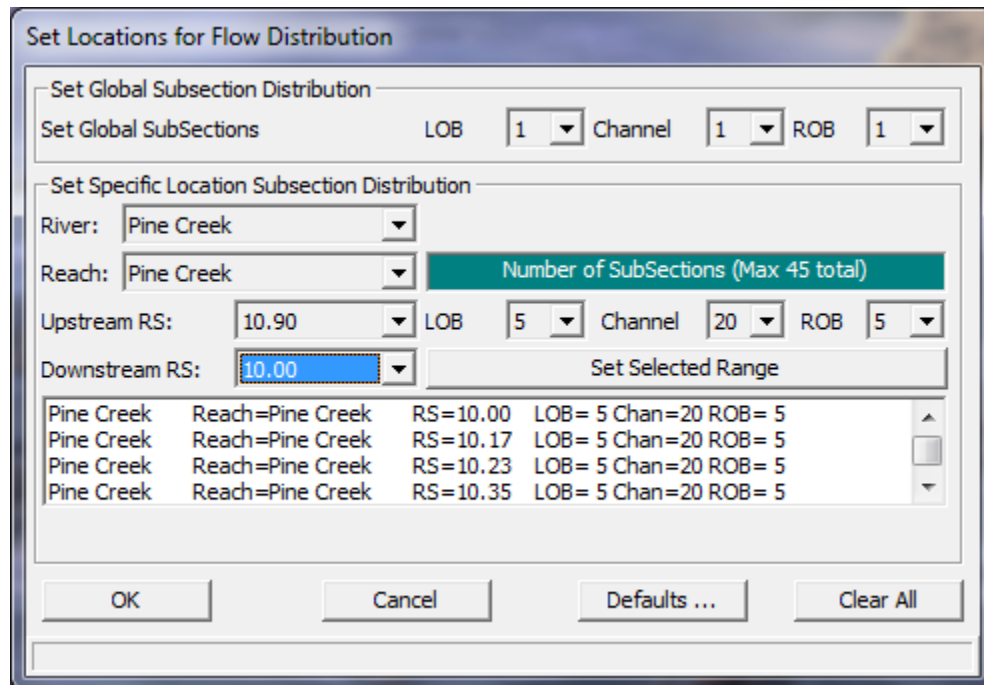

Figure 11-3: Flow Distribution Editor for Pine Creek

To perform the bridge scour calculations, the program requires detailed values of the depth and velocity within the cross sections located just upstream from the bridge (cross section 10.37 for this example) and at the approach section (cross section 10.48). Therefore, the modeler is required to set the flow distribution option for these two cross sections. For this example, the flow distributions were selected for the entire river reach. As shown in Figure 11.3, the left and right overbanks were divided into 5 subsections each, and the main channel was divided into 20 subsections. This will allow the program to produce detailed results of the distribution of depth and velocity at the cross sections.

The number of subsections is dependent upon such factors as the cross section geometry, the bridge opening width, and the number of piers. The modeler should perform the hydraulic calculations with different numbers of subsections to evaluate the impact on the bridge scour results. It is recommended to use fewer subsections, however, an adequate number of subsections is required to determine the hydraulic properties. For this example, the bridge scour calculations were also performed using 20 subsections for the main channel, and no appreciable changes were observed in the scour results. For a further discussion on the flow distribution option, the modeler is referred to chapter 7 of the **User's Manual** and to chapter 4 of the **Hydraulic Reference Manual**.

Finally, the flow distribution editor was closed and the data were saved as a plan entitled "Scour Plan 1." The **COMPUTE** button was then selected to execute the analysis.

At this point, the modeler should review the output from the hydraulic analysis and calibrate the model. It is important to obtain a good working model of the river system before attempting to perform a bridge scour analysis. For this example, the hydraulic analysis included the evaluation of the expansion and contraction reach lengths according to the procedures as outlined in the **Hydraulic Reference Manual**. Finally, after a working model has been developed, the user should evaluate the long-term aggradation or degradation for the river reach and incorporate this analysis into the working model.

## Hydraulic Design - Bridge Scour

After a working model of the river reach is developed and the long-term effects for the river system are evaluated, the modeler can perform the bridge scour computations. The scour computations are performed by selecting **Run, Hydraulic Design Functions, Functions**, and then **Scour at Bridges**. This will activate the **Bridge Scour Editor** as shown in Figure 11.4.

The top of the editor is used to select the *River, Reach, River Station, and Profile* number for the scour analysis. For this example, the river and reach is Pine Creek, the bridge is located at river station 10.36, and the scour analysis was for the first profile.

The remaining portion of the editor is divided into three areas: input data tabs, a graphic, and a results window. There are three tabs, one for each of the three types of scour computations: contraction, pier, and abutment. The graphic displays the bridge cross section (inside upstream). When the **Compute** button is selected, the scour results will be displayed graphically on the cross section and in tabular format in the results window. The following sections describe the parameters for each of the three data tabs.

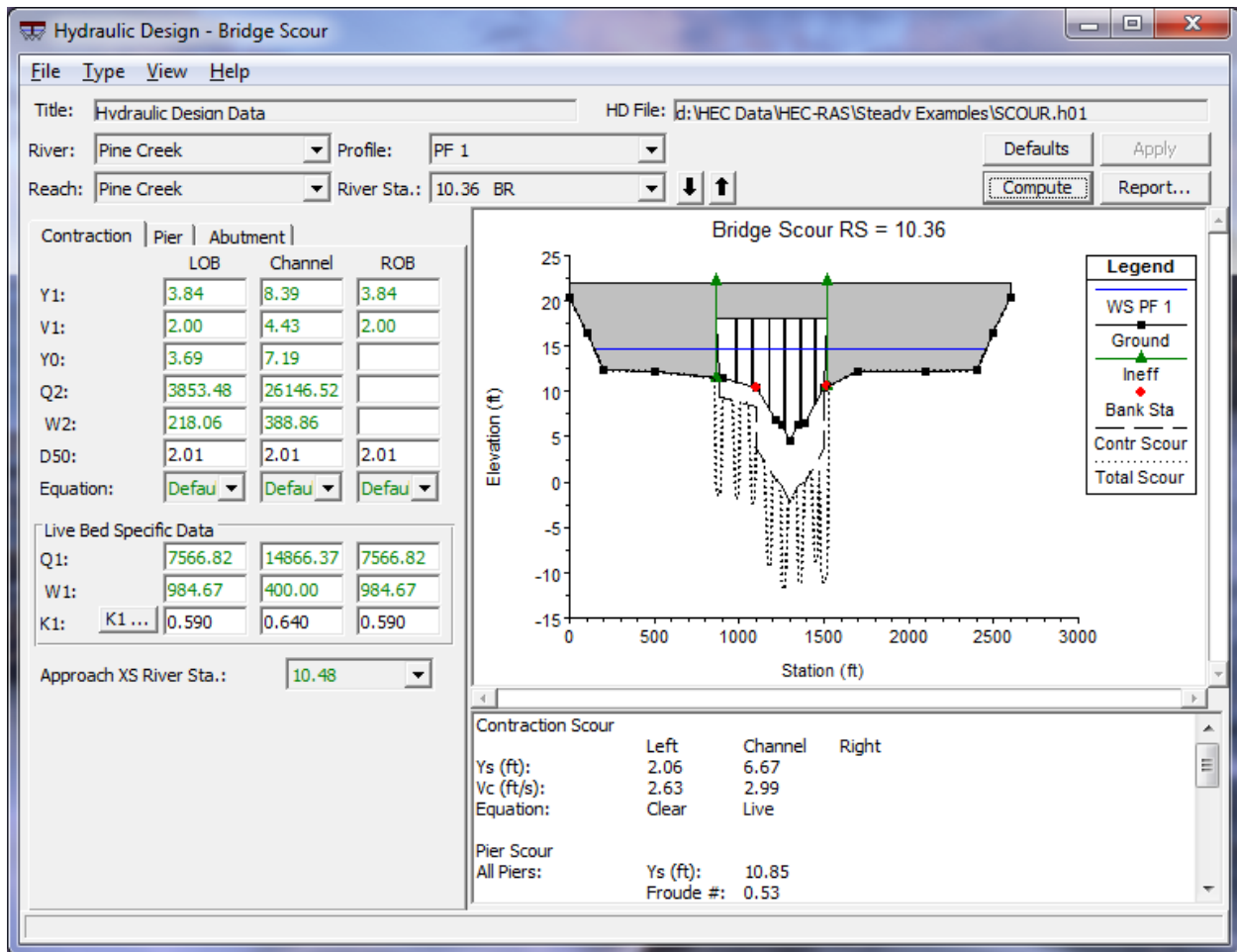

Figure 11-4: Hydraulic Design: Bridge Scour Editor – Contraction Tab

## Contraction Scour

Contraction scour occurs when the flow area of a stream is reduced by a natural contraction or bridge constricting the flow. There are two forms of contraction scour: live bed and clear water. The equations for the contraction scour are presented in chapter 10 of the **Hydraulics Reference Manual** and the variables for the equations are listed on the left side of the contraction tab, as shown in Figure 11.4. Additionally, the contraction tab is divided into three columns: for the LOB (left overbank), main channel, and ROB (right overbank). This allows the program to calculate the contraction scour for each of the three areas of the cross section.

When the **Bridge Scour Editor** is activated, the program will search the output file from the hydraulic analysis and fill in the values for the variables on the contraction tab with the appropriate results, as shown in Figure 11.4. (Note: As shown in the figure, the values for Y0, Q2, and W2 are zero for the ROB because the right sloping abutment extended into the main channel.)

The user can override any of these values by simply entering in a new value at the appropriate location. For the contraction scour analysis, the user is only required to provide the D50 mean size fraction of the bed material, the

water temperature for the K1 factor, and select the equation to be used for the analysis.

For this example, the D50 was entered as 2.01 mm, for each of the LOB, main channel, and ROB. To enter the water temperature, the **K1** icon was selected and this activated the **K1 Data Editor** as shown in Figure 11.5. As shown in Figure 11.5, the water temperature was entered as 60 °F and then the program automatically determined that the K1 value was 0.59, 0.59, and 0.59 for the LOB, main channel, and ROB, respectively. This editor was then closed.

	LOB	Channel	ROB
S1 :	0.000533	0.000533	0.000533
V* (ft/s):	0.26	0.38	0.26
Water Temp (F):		60.0	
w (ft/s):	0.6898	0.6898	0.6898
V*/w :	0.377	0.551	0.377
K1 :	0.590	0.640	0.590

OK Cancel

EG slope in approach section

Figure 11-5: K1 Data Editor

Finally, the down arrows adjacent to Equation were selected and the default option was chosen. This informed the program to use either the clear water or the live bed scour equation as determined from equation 10-1 in the **Hydraulic Reference Manual**.

To perform the contraction scour computations, the **Compute** button at the top of the editor was selected. When the calculations were completed, the results appeared in tabular form in the lower right corner of the editor and in graphical form on the bridge cross-section plot, as shown in Figure 11.4.

As a review of the results for the contraction scour, the critical velocity ( $V_c$ ) for the LOB was determined to be 2.63 ft/s, from equation 10-1. This value is greater than the velocity at the approach section ( $V_1 = 2.00$ ) in the LOB; therefore the clear water scour equation was used for the LOB, as listed in the summary table. Comparatively, the live-bed scour equation was used for the main channel because the critical velocity ( $V_c = 2.99$ ) was less than the approach section velocity ( $V_1 = 4.43$ ), in the main channel. Finally, the contraction scour depth ( $Y_s$ ) was determined to be 2.07 and 6.67 feet for the LOB and main channel, respectively. As a final note, there was no contraction scour in the ROB because the right abutment extended into the main channel. These contraction scour depths are also shown on the graphic display of the bridge cross section in Figure 11.4.

## Pier Scour

To enter the data for the pier scour analysis, the **Pier Tab** was selected. This tab is shown in Figure 11.6. For the pier scour analysis, the modeler has the option of using either the CSU or the Froehlich equation. As for the contraction scour tab, the program will automatically fill in the values for the variables from the results of the hydraulic analysis. The user may replace any of these values by changing the value in the appropriate field.

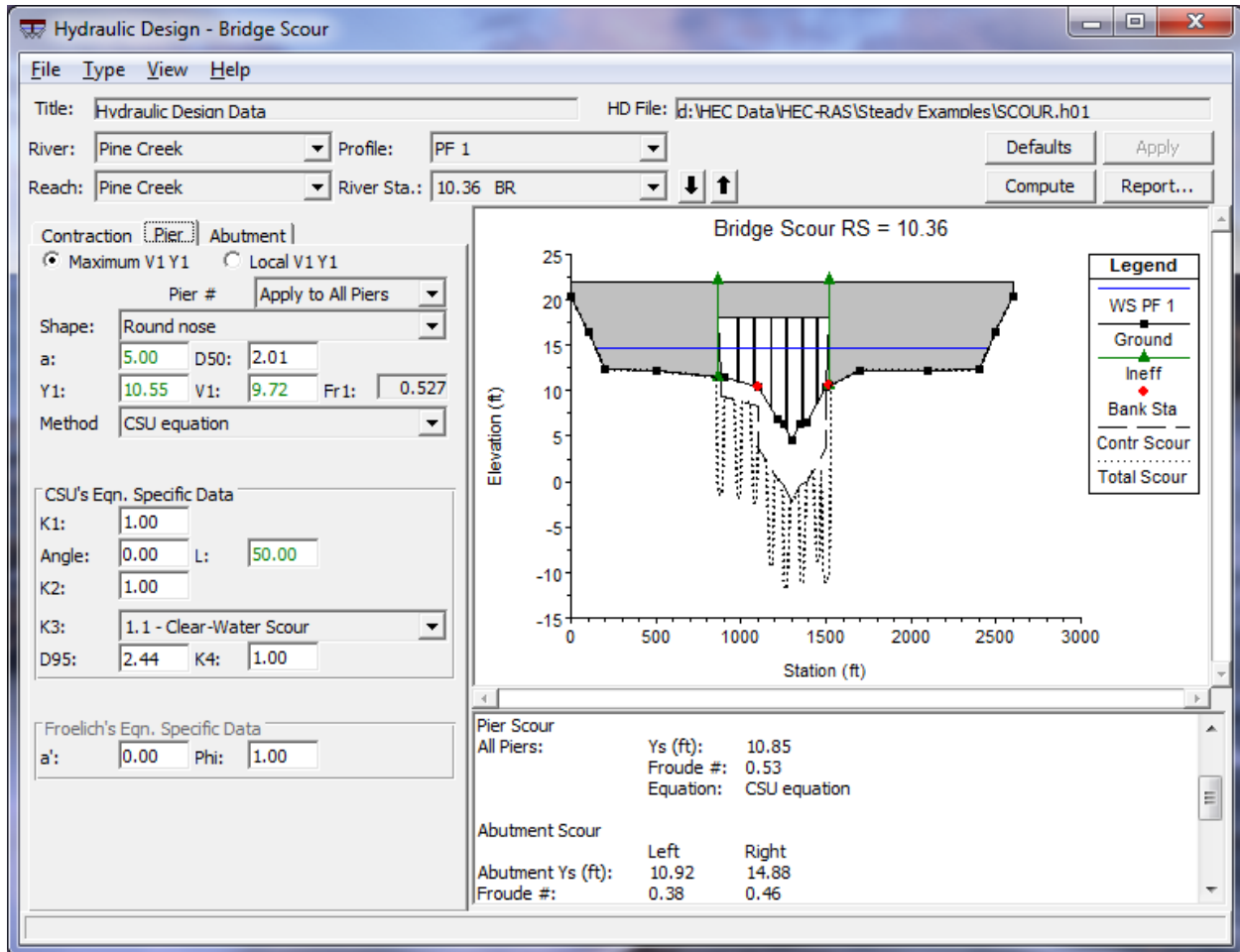

Figure 11-6: Hydraulic Design: Bridge Scour Editor – Pier Tab

For this example, the *Maximum V1 Y1* option was selected to inform the program to use the maximum value of the depth and velocity values, as opposed to the values upstream from each pier. Then, *Method* was selected as the “CSU equation.” Next, the *Pier #* option was selected as “Apply to All Piers” to inform the program that the data will be used for all of the piers. (The user has the option of entering the data for each individual pier.)

Next, the *Shape* of the piers was selected as “Round nose” which set the K1 value to be 1.00. Then, the  $D_{50}$  was entered as 2.01 mm. The angle was set to be 0 degrees which set the K2 value to be 1.00. Next, the bed condition was selected as “Clear-Water Scour” (this set  $K3 = 1.1$ ) and the D95 was entered as 2.44 mm.

This completed the required user input and then the **Compute** button was selected. The results were then displayed graphically and in the summary



table and showed that the pier scour depth ( $Y_s$ ) was 10.85 feet, as shown in Figure 11.6. (Note: When the compute button was selected, the program automatically computed all 3 scour depths: contraction, pier, and abutment.)

### Abutment Scour

To enter the data for the abutment scour, the **Abutment Tab** was selected and is shown in Figure 11.7. For the abutment scour computations, the program can use either the Froehlich or the HIRE equation. The variables for the equations appear on the left side of the tab and their values for the left and right abutment were automatically obtained from the hydraulic analysis results.

To perform the abutment scour analysis, the user must enter the abutment shape, the skew angle, and select the equation to be used. For this example, the shape (K1) was selected as "Spill-through abutment." This set the K1 value to be 0.55. Then, the *Skew* angle was entered as 90 degrees and this set K2 to be 1.00, for both the left and right abutment. Finally, the *Equation* was selected as "Default." With this selection, the program will calculate the  $L/y_1$  ratio to determine which equation to use. The modeler is referred to chapter 10 of the **Hydraulic Reference Manual** for a further discussion on the scour equations.

This completed the data entry for the abutment scour and the **Compute** button was selected. The results were then displayed on the graphic and in the summary table, as shown in Figure 11.7. The results show that the HIRE equation was used for both the left and right abutment and the magnitude of the scour was 10.92 and 14.88, respectively. Additionally, the summary table displayed the values of the Froude numbers used for the calculation.

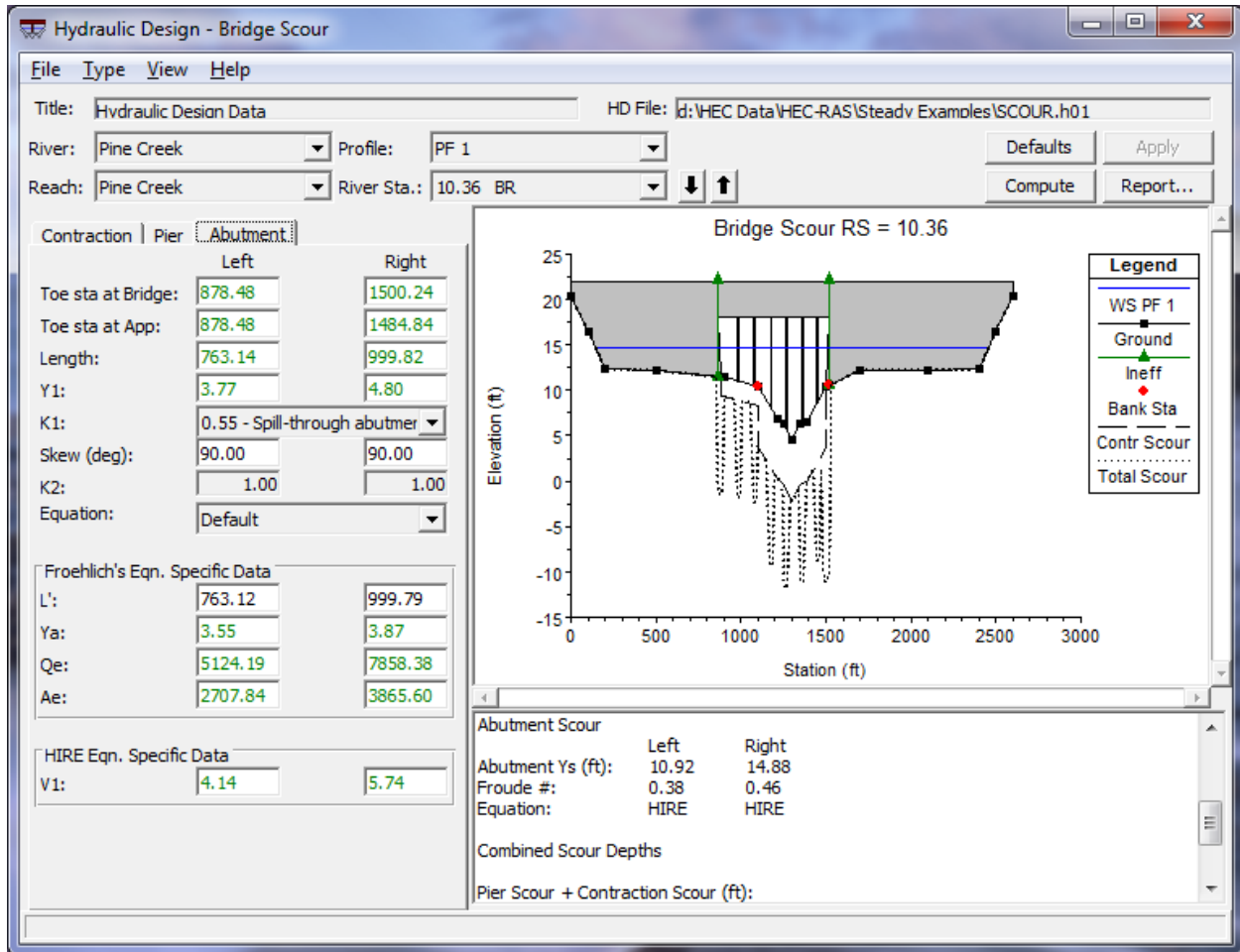

Figure 11-7: Hydraulic Design: Bridge Scour Editor – Abutment Scour

### Total Bridge Scour

The total bridge scour is the combination of the contraction scour and the local scour (pier or abutment). To review the total scour, the user can toggle to the bottom of the summary table. For this discussion, a portion of the summary table is shown as Table 11.1. This table was obtained by selecting **Copy Table to Clipboard** under the **File** menu.

Table 11-1 Summary of Results for Bridge Scour

<b>Contraction Scour</b>			
	Left	Channel	Right
Ys:	2.06	6.67	
Eqn:	Clear	Live	Default

<b>Pier Scour</b>		
All Piers:	Ys=	10.85
	Eqn=	CSU equation

<b>Abutment Scour</b>		
	Left	Right
Abutment Ys:	10.92	14.88
Equation:	HIRE	HIRE

<b>Combined Scour Depths</b>	
Pier Scour + Contraction Scour	
Left Bank:	12.92
Channel:	17.52
Left abut + contr:	12.98
Right abut + contr:	21.55

The first three portions of the table display the results of the contraction, pier, and abutment scour, as discussed previously. The final portion of the table displays the combined scour depths. For this example, the pier and contraction scour was 12.91 feet ( $= 10.85 + 2.06$ ) for the left bank and 17.52 feet ( $= 10.85 + 6.67$ ) for the main channel. Additionally, the total left abutment and contraction scour was 12.98 feet ( $= 10.92 + 2.06$ ) and the right abutment and contraction scour was 21.55 feet ( $= 14.90 + 6.67$ ). The contraction scour for the right abutment was the contraction scour for the main channel because the right abutment extended into the main channel.

Finally, the total scour is displayed graphically, as shown in Figure 11.8. (Note: The graphic has been zoomed in to see more detail.) As shown in the legend, the long dashed line represents the contraction scour and the short dashed line portrays the total scour. This graphic was obtained by selecting **Copy Plot to Clipboard** from the **File** menu.

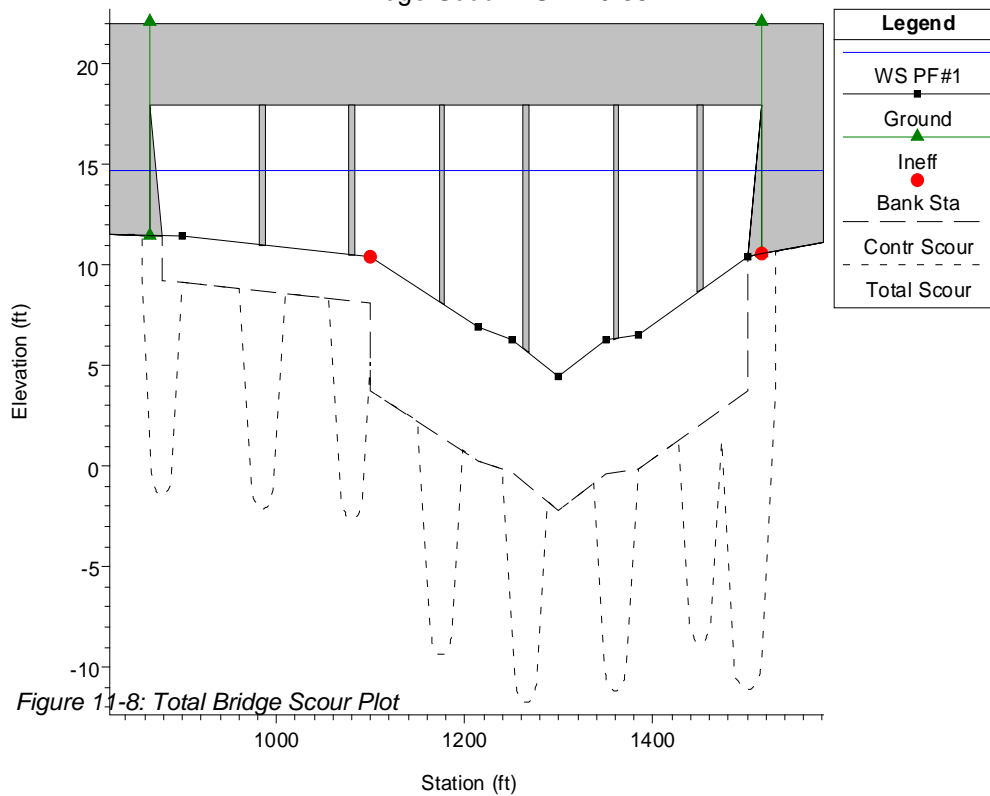

## Summary

To perform the bridge scour computations, the user must first develop a model of the river system to determine the hydraulic parameters. Then, the program will automatically incorporate the hydraulic results into the bridge scour editor. The user can adjust any of the values that the program has selected. For each particular scour computation, the modeler is required to enter only a minimal amount of additional data. The results for the scour analysis are then presented in tabular form and graphically. Finally, the user can select **Detailed Report** from the **Bridge Scour Editor** to obtain a table displaying a full listing of all the input data used and the results of the analysis.

## CHAPTER 12

# Inline Structure

### Purpose

This example will demonstrate the use of HEC-RAS to analyze a river reach that contains an inline weir and gated spillways. For each inline structure location, the program can analyze up to 10 gate groups, with a maximum of 25 gates per group.

To perform the analysis, the user must enter the geometric data for the weir and gated spillway, along with the geometry of the river reach. Then, the user must set the number of gates that are open and the opening height of each gate group for each flow profile. The modeler is referred to Chapter 6 of the User's Manual for discussion on entering the geometric data for the weir and gated spillways, Chapter 7 of the User's Manual for entering the gate opening flow data, and Chapter 8 of the Hydraulic Reference Manual for the hydraulic analysis procedures for analyzing the flow through the gate openings and over the weir.

To review the data files for this example, from the main HEC-RAS window, select **File** and then **Open Project**. Go to the directory in which you have installed the HEC-RAS example data sets. From the "Steady Examples" subdirectory, select the project labeled "Inline structure - Example 12." This will open the project and activate the following files:

Plan:	"Gated Spillway"
Geometry:	"Gate Geometry with 3 Gate Groups"
Flow:	"7 Flow Profiles"

### Geometric Data

To view the geometric data for the river system, from the main program window select **Edit** and then **Geometric Data**. This will activate the **Geometric Data Editor** and display the river system schematic as shown in Figure 12.1. The schematic displays the 35 river stations of the reach "Weir Reach" on "Nittany River", with river station 60.1 as the upstream cross section and 36.85 as the downstream cross section.

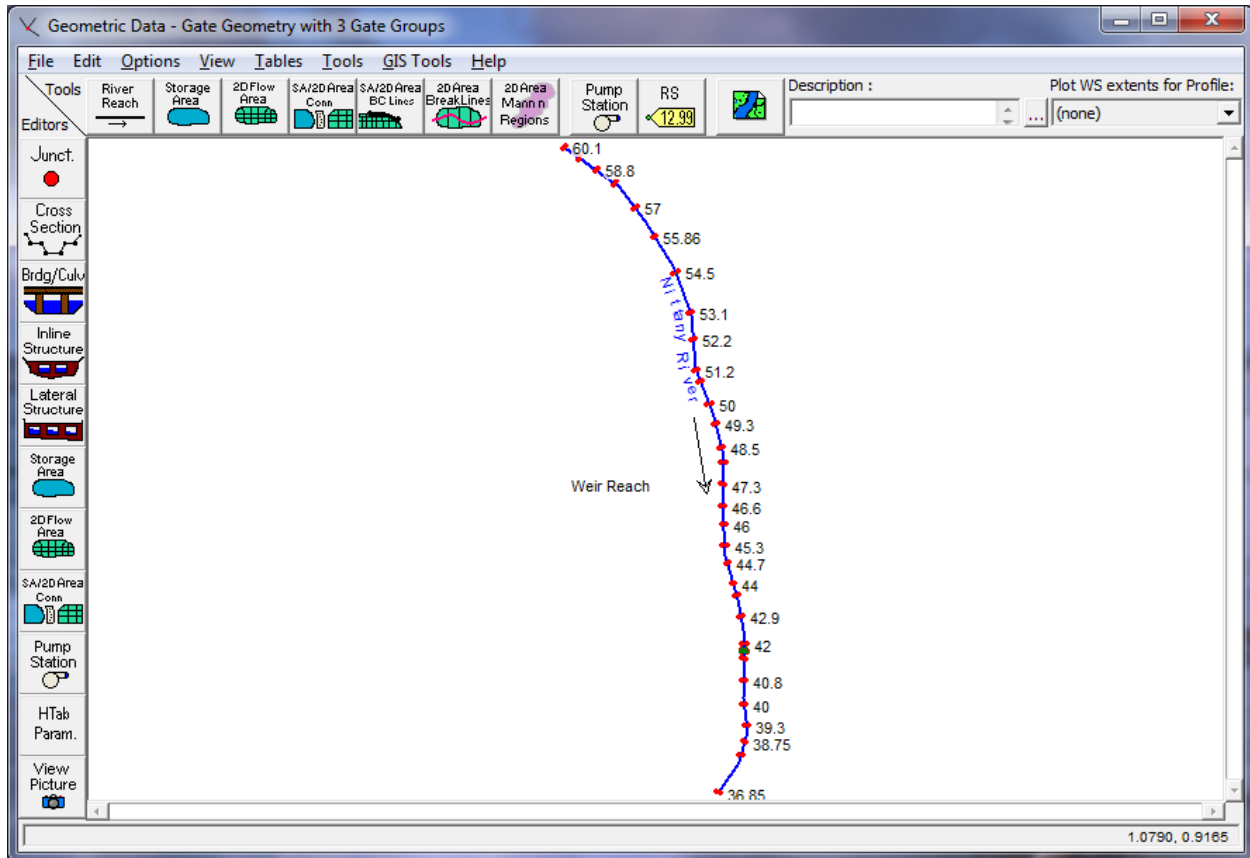

Figure 12-1: River System Schematic for Nittany River

### Cross Section Data

The cross section data consists of the X-Y coordinates, Manning's n values, contraction and expansion coefficients, etc. The user can view this data for each river station by selecting the **Cross Section** icon on the left side of the **Geometric Data Editor**. For this example, an inline structure was added at river station 41.75 and will be discussed in the next section. Figure 12.2 displays the reach lengths in the vicinity of the inline structure and was activated by selecting **Tables** and then **Reach Lengths** from the **Geometric Data Editor**.

### Inline Structure

To add an **inline structure**, the **Inline Structure** icon was selected from the left side of the **Geometric Data Editor**. This activated the **Inline Structure Data Editor** as shown in Figure 12.3. First the reach "Weir Reach" was selected. Then, **Options** and **Add an Inline Structure** were selected and river station 41.75 was entered as the location for the weir. The schematic then displayed the cross section data for the river station immediately upstream of the weir location: namely river station 41.76 for this example. A description for the weir was then entered as "Inline Weir and Spillway."

Edit Downstream Reach Lengths

River: Nittany River  Edit Interpolated XS's

Reach: Weir Reach

Selected Area Edit Options

Add Constant ... Multiply Factor ... Set Values ... Replace ...

	River Station	LOB	Channel	ROB
22	43.6	3696	3696	3696
23	42.9	4752	4752	4752
24	42	1180	1180	1180
25	41.78	100	100	100
26	41.76	90	90	90
27	41.75	Inl Struct		
28	41.74	200	200	200
29	41.70	1070	1070	1070
30	41.5	3696	3696	3696
31	40.8	4224	4224	4224
32	40	3696	3696	3696

OK Cancel Help

Figure 12-2: Reach Length Table for Nittany River

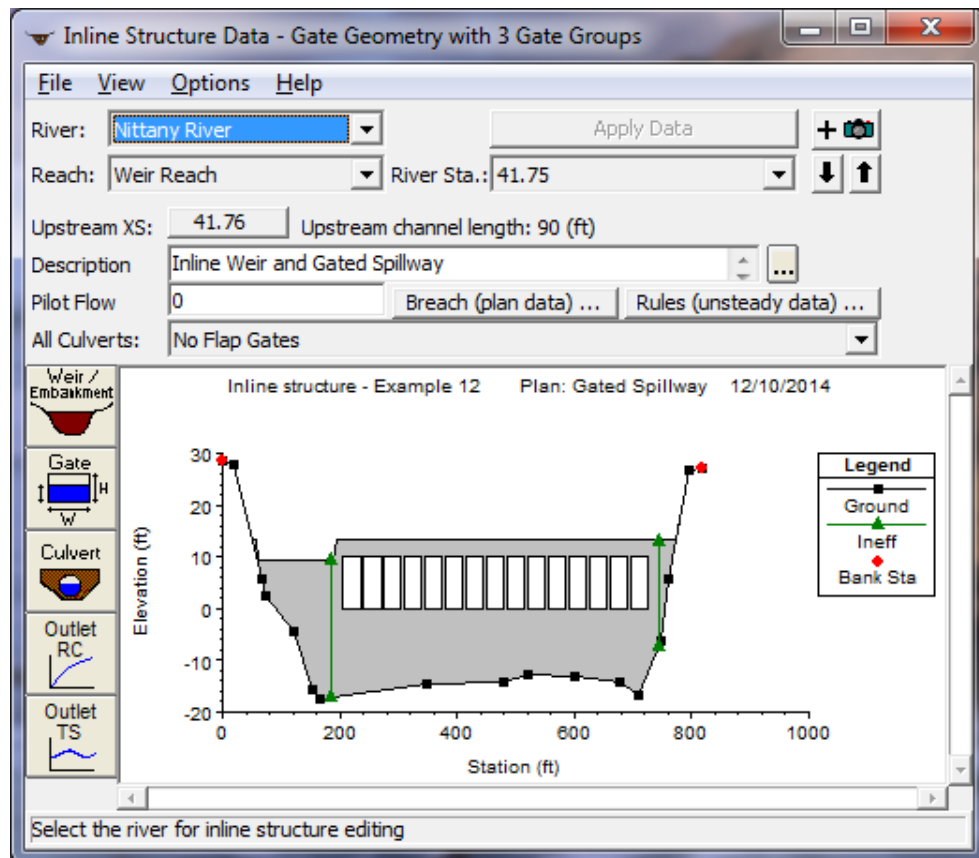

Figure 12-3: Inline Structure Data Editor

To enter the data for the weir, the **Weir/Embankment** icon was selected from the left side of the **Inline Structure Data Editor**. This activated the **Inline Structure Station Elevation Data Editor** as shown in Figure 12.4. This editor is similar to the deck/roadway editor used for bridges and culverts.

Distance	Width	Weir Coef
20	50	3.95

Edit Station and Elevation coordinates		
	Station	Elevation
1	0.	13.5
2	57.	13.5
3	61.	9.5
4	190.	9.5
5	194.	13.5
6	1000.	13.5
7		
8		

U.S Embankment SS: 2      D.S Embankment SS: 2

**Weir Data**  
**Weir Crest Shape**  
 Broad Crested  
 Ogee  
 Spillway Approach Height: 24  
 Design Energy Head: 3      Cd ...

OK      Cancel

Enter distance between upstream cross section and deck/roadway. (ft)

Figure 12-4: Inline Structure Station Elevation Data Editor

The top row of the editor consists of three data entry fields. For the first field, the user must enter the *Distance* from the upstream cross section (41.76) to the upstream side of the weir. For this example, this distance was 20 feet. Next, the *Width* of the weir was entered as 50 feet. This is a total distance of 70 feet. From Figure 12.2, it can be seen that the distance from river station 41.76 to 41.74 is 90 feet. Therefore, the distance from the downstream end of the weir to cross-section 41.74 is 20 feet. The last field in the top row of the editor is the *Weir Coefficient*. This will be discussed shortly.

The central portion of the editor consists of a table in which the user must enter the station and elevation data for the weir. For this example, the emergency spillway is located on the left at an elevation of 9.5 feet from Station 61 to 190; however, the entire top-of-dam is defined. The first station of the weir was entered as 0 and the last station is at 1000 feet. With these weir stations and elevation, the program will block out the entire area below the weir crest. In this manner, the data entry is similar as that for a culvert.

Additionally, it should be noted that the weir station values of 0 and 1000 occur beyond the limits of the cross section data. As for the bridge and culvert routines, the program will automatically “clip off” the excess area so that the weir coincides with the cross section geometry.

The next fields are for the upstream and downstream embankment side slopes. For this example, the slope of two was entered for the **US** and **DS Embankment S.S.** fields.



At the bottom of the editor are several other required variables. The *Min Weir Flow Elevation* was left blank which implies that the lowest elevation of the weir will be used to determine when weir flow begins to occur. Finally, the shape of the weir was entered as "Ogee" for the *Submergence* criteria. When ogee was selected, the editor expanded to allow for two more fields of entry. These fields are the *Spillway Approach Height* and *Design Energy Head*. The approach height was entered as 24 feet and the design head was 3 feet for the ogee shape. To determine the weir coefficient with these design parameters, the **C<sub>d</sub>** button was selected and the program calculated a coefficient of 3.95, as shown in Figure 12.5.

The "Yes" button was selected and then the coefficient appeared at the top of the **Inline Structure Station Elevation Data Editor** in the *Weir Coefficient* field. If the weir shape had been selected as "Broad Crested", the user is required to enter the value of the weir coefficient. This completed the data entry for the weir. Next, the data for the gates were entered.

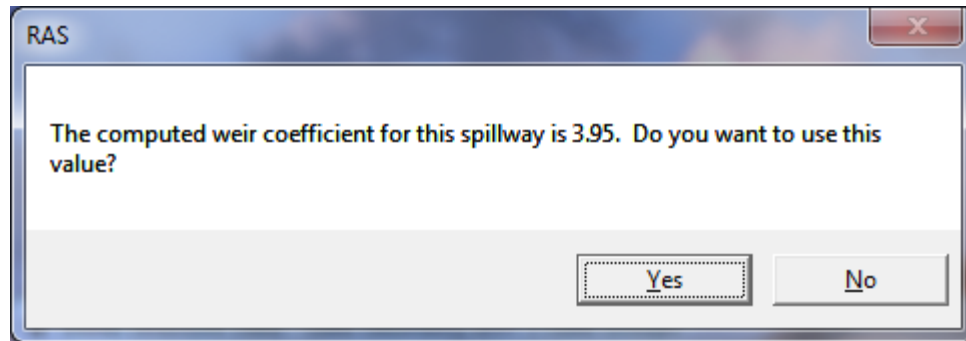

Figure 12-5: Ogee Weir Shape Coefficient

## Gated Spillways

To enter the data for the gates, the **Gate** icon was selected from the **Inline Structure Data Editor** (Figure 12.3). This activated the **Gate Editor** as shown in Figure 12.6. For this example, 15 radial gates were entered. The gates were divided into 3 groups, with 5 gates in each group. The gates were divided into three groups to allow for flexibility when setting the gate opening heights. This will be discussed further when the opening heights are set in the steady flow data editor.

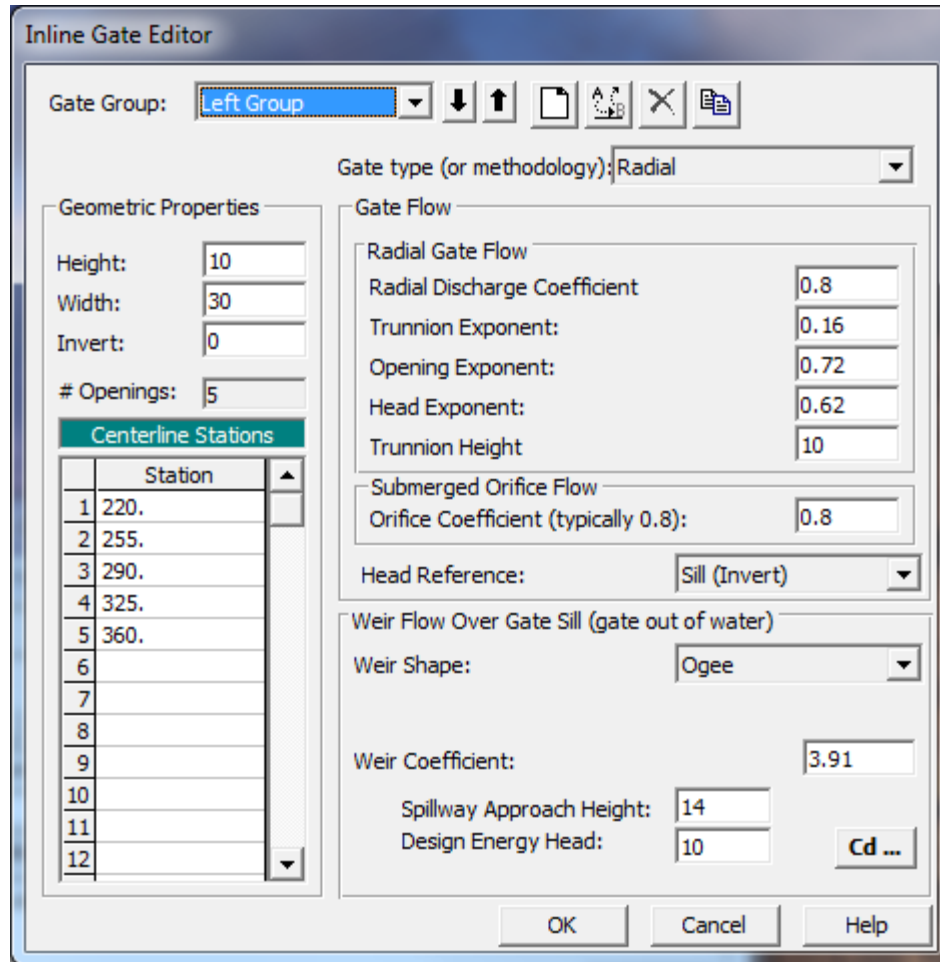

Figure 12-6: Gate Editor

When the **Gate Editor** was activated, the first gate was labeled as “Gate #1.” For this example, the *Rename* button was selected and the label “Left Group” was entered. Next, the *Height*, *Width*, and *Invert* for the gates of the Left Group were entered as 10, 30, and 0 feet, respectively. On the lower left side of the editor, the centerline stations for the five gates in the “Left Group” were entered as shown in Figure 12.6. As these values were entered, the counter field # *Openings* increased to represent the total number of gates for the group (5 for this example).

The remaining portion of the editor is divided into two sections, one for the Gate Flow data and one for Weir Flow data. The gate data is used when the water surface upstream of the gate is greater than 1.25 times the gate opening (as measured from the gate invert). At this water surface elevation, the gate is controlling the flow rate. The weir data is the shape of the weir under the gate and is used when the upstream water surface is less than or equal to the gate opening. At this water surface elevation, the weir under the gate is controlling the flow through the gate opening (i.e., the water is not in contact with the gate).

For the gate data, the first field is the *Gate Type*. By selecting the down arrow, the type “Radial” was chosen. When the gate type was selected, the *Radial Discharge Coefficient*, *Trunnion Exponent*, *Opening Exponent*, *Head Exponent*, and *Trunnion Height* values were automatically set to 0.80, 0.16,

0.72, 0.62, and 10.0 respectively. The orifice coefficient of 0.8 was entered for fully submerged flow conditions. Additionally, the head reference for the gate equation defaults to the "Sill (invert)" of the gate opening. This is appropriate for gates that release water to a channel, rather than to the free atmosphere.

For the Weir Flow data, the *Weir Shape* was selected as "Ogee". This caused the editor to add the data fields for *Spillway Approach Height* and *Design Energy Head*. The distances of 14 and 3 feet were then entered for each of these fields, respectively. Finally, the Cd button was selected and a window appeared similar to Figure 12.5, with a coefficient of 3.91. The "Yes" button was selected and the weir coefficient appeared in the weir data area at the bottom of the **Gate Editor**.

This completed the data entry for the gates in the "Left Group." Next, the **Add** button at the top of the **Gate Editor** was selected and this added another gate group. The group was renamed to "Center Group" and the data for 5 new gates were entered exactly as for the Left Group, except for the centerline stations. Finally, a third gate group was added and renamed "Right Group," with the data entry as for the two previous groups with new centerline stations.

The **OK** button was selected at the bottom of the **Gate Editor** and the gates appeared on the **Inline Structure Data Editor** as shown in Figure 12.3. (Note: The ineffective flow areas will be entered subsequently.) At this point, the user should zoom in on the gate openings to ensure that they do not overlap and appear as intended. The **Inline Structure Data Editor** was then closed.

## Ineffective Flow Areas

As performed for bridges and culverts, ineffective flow areas should be entered on the cross sections that bound the inline structure. For this example, the cross section that is upstream of the structure is 41.76 and the cross section downstream of the structure is 41.74. To enter the ineffective flow areas, the **Cross Section** icon was selected from the **Geometric Data Editor** (Figure 12.1). Then, river station 41.76 was selected and **Ineffective Flow Areas** was selected from the **Options** menu. This activated the **Ineffective Flow Editor** as shown in Figure 12.7.

The distance from the inline structure (river station 41.75) to river station 41.76 is 20 feet. The left edge of the gates at river station 41.75 is 205. Therefore, the left ineffective flow area was set to begin at  $205 - 20 = 185$ . Similarly, the right ineffective flow area was set at 745 ( $= 725 + 20$ ). The elevation on the left is 9.5 feet, at the top of the spillway, and the right is 13.5, the top-of-dam. The **OK** button on the editor was selected and similar ineffective flow areas were entered at river station 41.74.

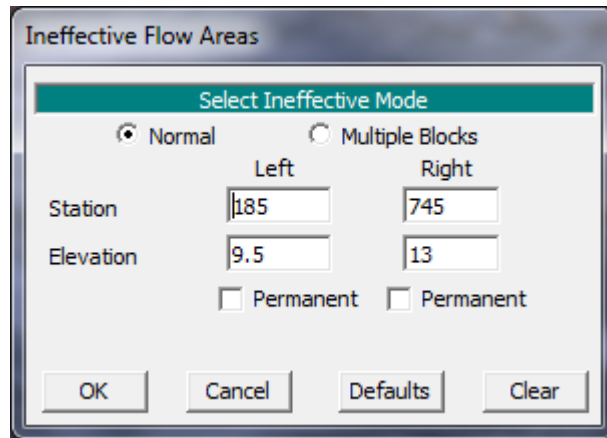

Figure 12-7: Ineffective Flow Editor

### Cross Section Placement

The final component of the geometric data concerns the placement of the cross sections in reference to the inline structure. As for bridges and culverts, the flow will contract to enter the gate openings and expand after the exiting the gate openings. The program will use 4 cross sections located on both sides of the structure to define the contraction and expansion of the flow through the structure. To provide guidance for the expansion reach length and contraction reach length, the tables in Appendix B of the **Hydraulic Reference Manual** were utilized. These tables were developed based on data for flow through bridges, however, they were used to provide general guidance.

To determine the expansion reach length, the following data was used:

$$b = 520$$

$$B = 660$$

$$b/B = 0.79$$

$$S = 0.4$$

$$n_{ob}/n_c = 1$$

- where:
- b = gate openings area, ft
  - B = floodplain width, ft
  - S = channel slope, ft/mi
  - n<sub>ob</sub> = Manning's n value of the overbank at river station 41.78
  - n<sub>c</sub> = Manning's n value of the main channel at river station 41.78

From Table B.1, the expansion ratio (ER) is approximately 2.0. Using an average length of obstruction ( $L_{obs}$ ) of approximately 100 feet yields an expansion reach length ( $L_e$ ) of:

$$L_e = (ER)(L_{obs}) = (2.0)(100) = 200 \text{ feet}$$

The expansion reach length is measured downstream from river station 41.74. Therefore, a cross section (41.70) was placed 200 feet downstream from river station 41.74. River station 41.70 represents the cross section where the flow is fully expanded.

For the contraction reach length, the contraction ratio (CR) was obtained as 1.0 from Table B.2. With this value, the contraction reach length ( $L_c$ ) is:

$$L_c = (CR)(L_{obs}) = (1.0)(100) = 100 \text{ feet}$$

The contraction reach length is measured upstream from river station 41.76. Therefore, a cross section (41.78) was placed 100 feet upstream from river station 41.76. River station 41.78 represents the cross section where the flow lines are parallel.

As a final note, the values for  $b$ ,  $B$ , and  $L_{obs}$  were approximated for the flow rate of 75,000 cfs. As the flow rate changes, the length of expansion and contraction would also change. For this example, the values that were determined for this flow rate were held constant for all of the flow rates.

This concluded the entry for all of the geometric data. At this point, the geometric data was saved as the file "Gate Geometry with 3 Gate Groups." Next, the flow data was entered.

## Steady Flow Data

The flow data consisted of three components: the flow rates for each profile; the boundary conditions; and the gate elevation settings. Each of these components are described in the following sections.

### Flow Profiles

To enter the flow data, the **Steady Flow Data Editor** (as shown in Figure 12.8) was activated from the main program window by selecting **Edit** and then **Steady Flow Data**. For this example, the number of flow profiles was selected as 7. When this number was entered, the table in the central portion of the editor expanded to provide 7 columns of data entry. The river reach "Weir Reach" (the only reach for this example) and the upstream river station of 60.1 appeared (by default) as the location for the flow data. The seven flow values of 5000, 10000, 20000, 30000, 40000, 50000, and 75000 cfs were entered as shown in Figure 12.8. No additional flow change locations were entered.

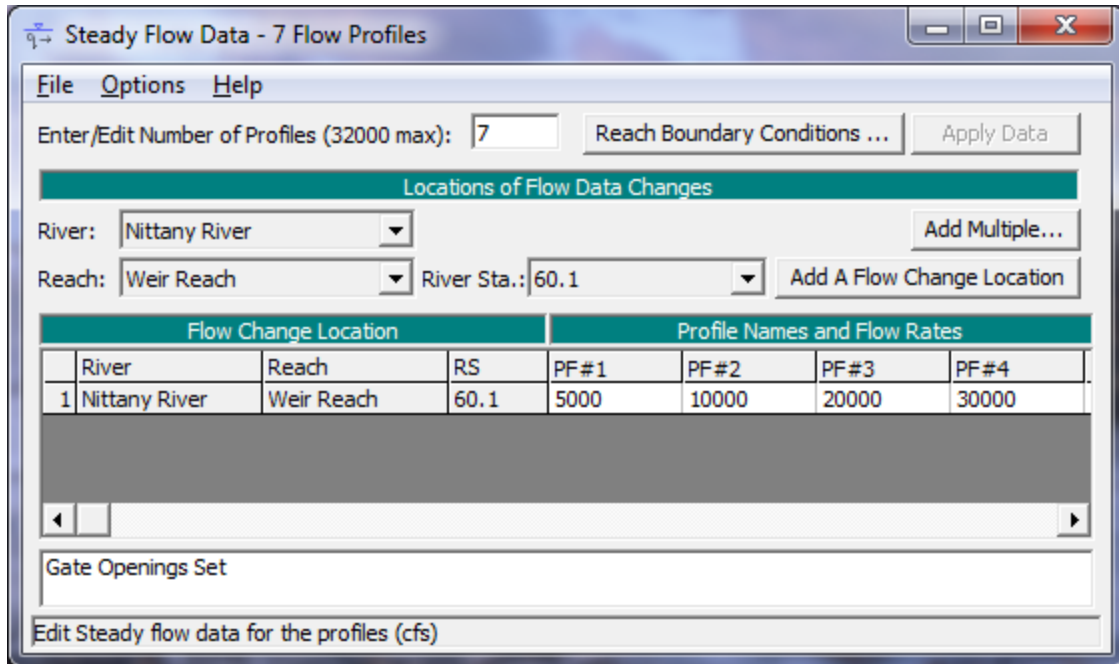

Figure 12-8: Steady Flow Data Editor

## Boundary Conditions

After the flow data was entered, the boundary conditions were entered by selecting the **Reach Boundary Conditions** button at the top of the **Steady Flow Data Editor**. This activated the **Boundary Conditions Editor** as shown in Figure 12.9. For this example, a subcritical analysis was performed. Therefore, boundary conditions were entered at the downstream end of the river reach. The field under *Downstream* was selected and then *Rating Curve* was chosen. This activated the **Rating Curve Editor** as shown in Figure 12.10. The flow values and corresponding water surface elevations were then entered in the editor, a portion of which is shown in Figure 12.10.

(Note: If the flow rate for a profile is less than the first rating curve data point, then the program will linearly interpolate a starting elevation between the first rating curve point and the downstream cross section invert.) After the data were entered, the **OK** button was selected to close the editor. This caused the title "Rating Curve" to appear in the "Downstream" field, as shown in Figure 12.9. The **OK** button was then selected on the **Boundary Conditions Editor**.

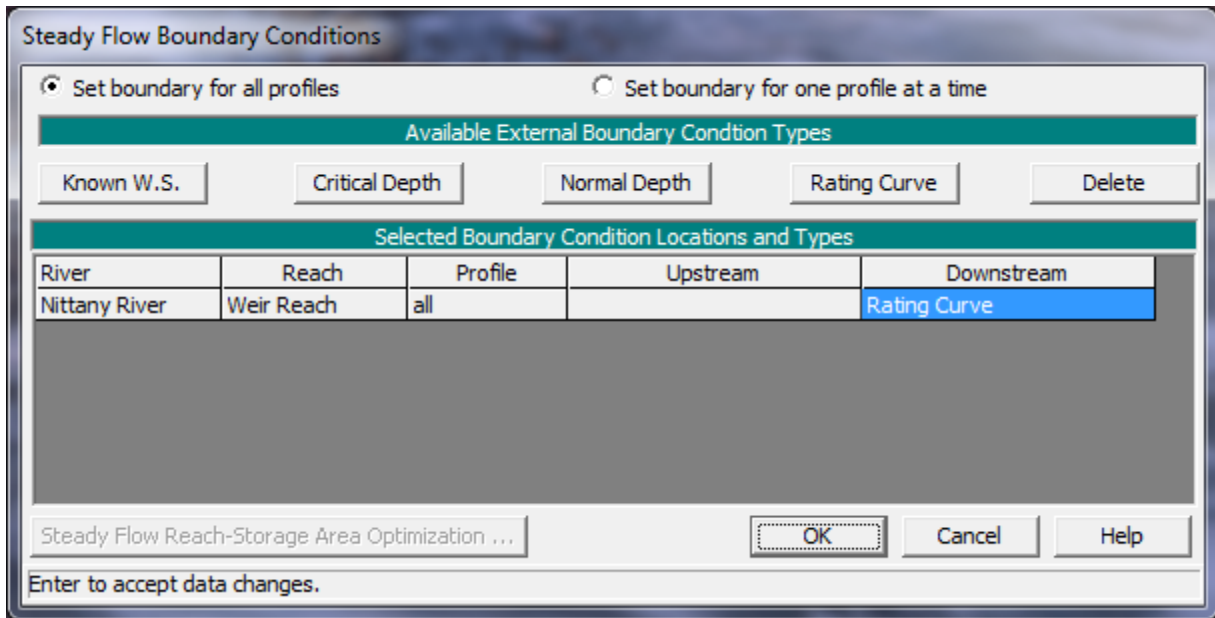

Figure 12-9: Boundary Conditions Editor

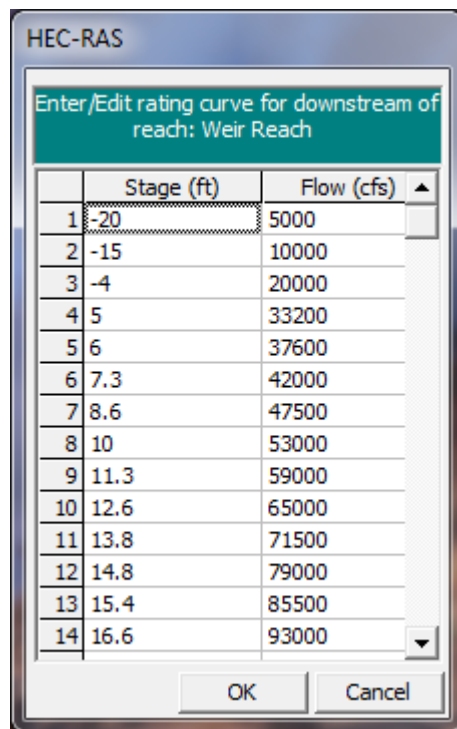

Figure 12-10: Rating Curve Editor

## Gate Openings

The final data entry for the analysis was the gate opening heights. To enter this data, from the **Steady Flow Data Editor, Options** and then **Inline Spillway Gate Openings** were selected. This activated the **Inline Spillway Gate Openings Editor** as shown in Figure 12.11.

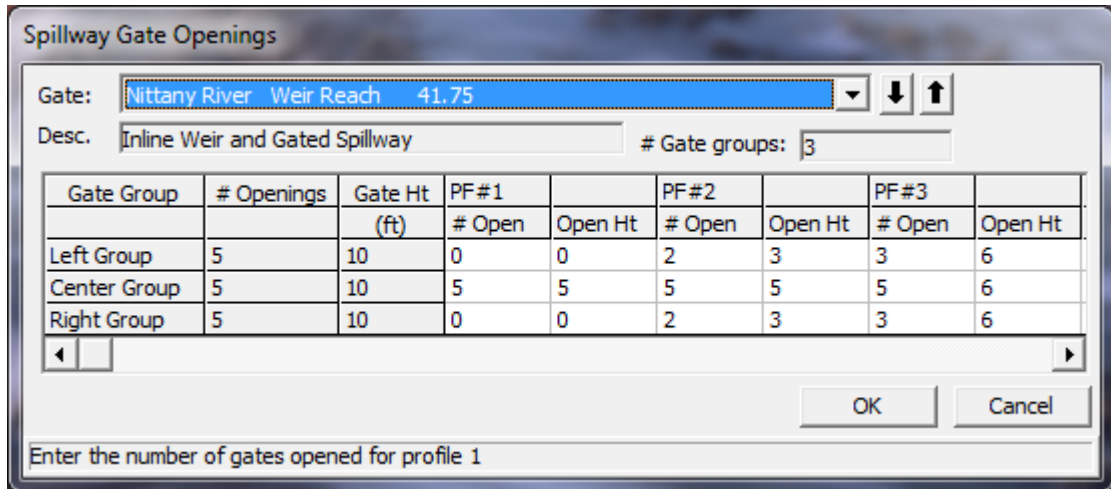

Figure 12-11: Inline Spillway Gate Openings Editor

At the top portion of the editor, the River "Nittany River," Reach "Weir Reach" and the River Station "41.75" were selected. The Description is the same as was entered in the **Inline Structure Data Editor** (Figure 12.3). The # Gate Groups field shows that there are 3 gate groups at this river station. The table in the central portion of the editor has 3 rows for this example, one row for each of the gate groups. The first column lists the descriptions for the gate groups, as they were named in the **Gate Editor** (Figure 12.6). The second column displays the number of gate openings for each gate group (5 for each gate group for this example). The third column displays the maximum gate height for each gate group (10 feet for each gate group for this example).

The remaining portion of the editor consists of entry fields for the number of gates opened and the opening heights of the gates for each flow profile. For this example, for profile 2, the Left and Right Gate Groups were set to have 2 gates open, each with an opening height of 3 feet. The Center Group was set to have 5 gates open, each at 5 feet. Since the gates were entered as three groups, the flexibility existed to have each gate group opened at different heights. If all 15 gates had been entered as only one group, then all of the gates that were open would have to have been set at the same opening height.

The user can toggle across the table to view the number of gates open and the gate opening heights for all of the profiles. During the analysis of the output, the various gate settings will be discussed. This concluded the data entry for this example. At this point, the **OK** button at the bottom of the editor was selected and the flow data was saved as "7 Flow Profiles."

## Steady Flow Analysis

After all of the data had been entered, the steady flow analysis was performed by activating the **Steady Flow Analysis Window**. This window was activated from the main program window by selecting **Run** and then **Steady Flow Analysis**, and is shown in Figure 12.12.



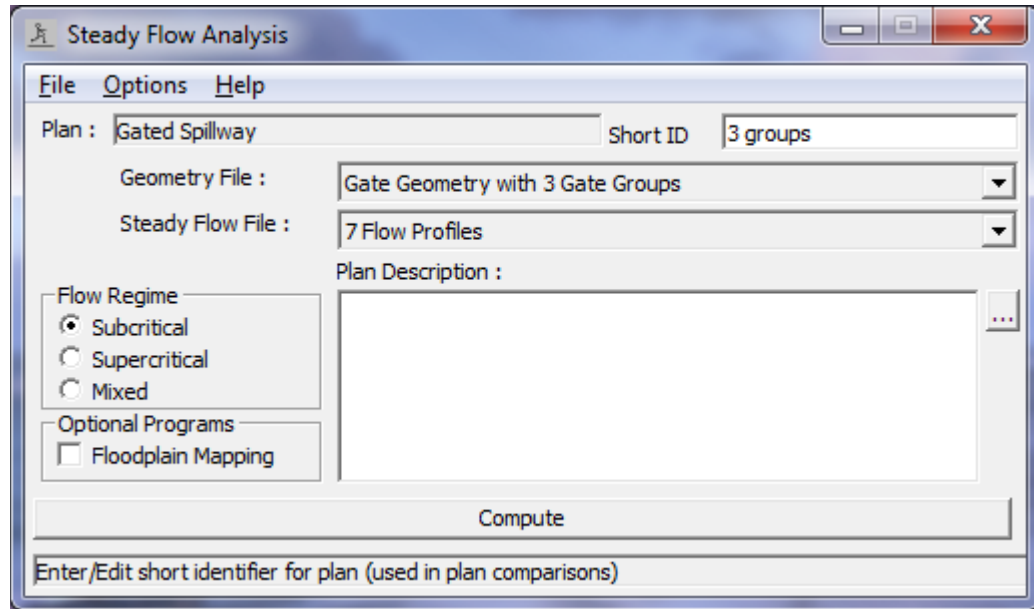

Figure 12-12: Steady Flow Analysis Window

First, the *Short ID* was entered as “3 groups.” The geometry file was then selected as “Gate Geometry with 3 Gate Groups” and the flow file was “8 Flow Profiles.” Next, the *Flow Regime* was selected as “Subcritical.” Then, File and Save Plan As were chosen and the information was saved as the plan “Gated Spillway.” This plan name then appeared on the **Steady Flow Analysis Window**, as well as on the main program window. Finally, the **COMPUTE** button was selected to perform the analysis.

## Output Analysis

For the analysis of the output, the water surface profiles, the inline structure type cross section table, and the inline structure type profile table will be reviewed. Each of these are discussed in the following sections.

### Water Surface Profiles

The water surface profiles are shown in Figure 12.13. This figure was activated from the main program window by selecting **View** and then **Water Surface Profiles**. The figure shows all 7 of the flow profiles.

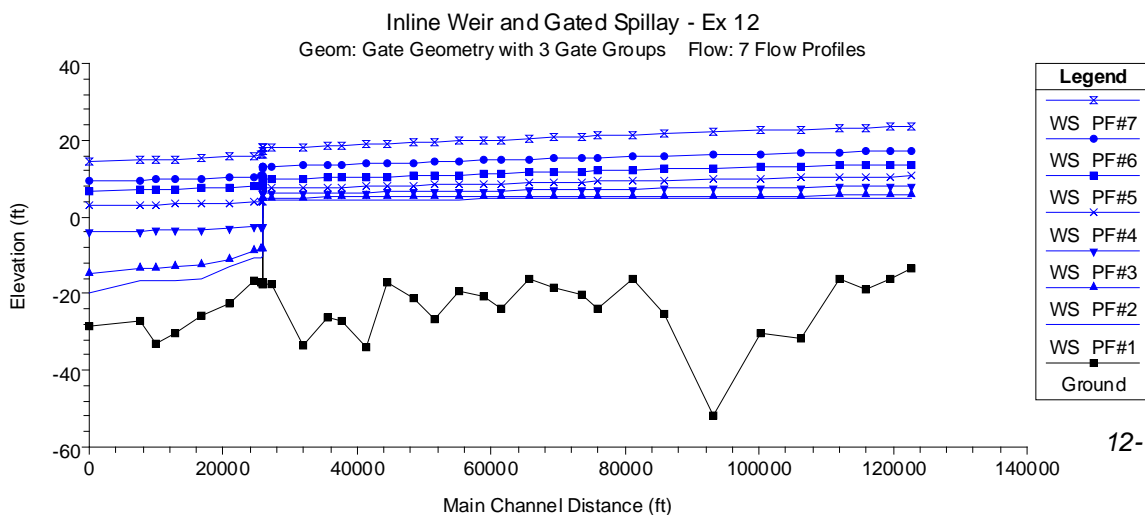

Figure 12-13: Water Surface Profiles for Nittany River

### Inline Structure Detailed Output Table

To review the flow parameters through the gate openings, the **Inline Structure** type **Detailed Output Table** was activated and is shown in Figure 12.14. This table was activated from the main program window by selecting **View, Detailed Output Table, Type**, and then **Inline Structure**.

At the top of the table, the *Reach* was selected as "Weir Reach" and the river station was 41.75 (the cross section for the inline structure). The profile was selected as "1" and the *Gate ID* was selected as "Center Group." For this profile, the Left and Right Gate Groups did not have any gates opened; therefore, only the Center Group will be discussed.

The Center Group had been set (as shown in Figure 12.11) to have 5 gates open at a height of 5 feet. Figure 12.14 displays this information in the right column. With a gate invert of -10 and a gate opening height of 5, the top of the gate opening was at -5 feet. The left side of Figure 12.14 shows that the water surface at river station 41.76 was at an elevation of 4.56 feet. Therefore, the water surface did not come into contact with the top of the gate opening and weir flow through the gate openings occurred. The weir data that was used to calculate the upstream energy grade line was the data that had been entered in the **Gate Editor** (Figure 12.6), not the weir data as entered in the **Inline Structure Station Elevation Data Editor** (Figure 12.4). Additionally, the *Gate Area* field shows a gate flow area of 136.81 ft<sup>2</sup>. With a gate opening height of 5 feet and a width of 30 feet, the total gate opening area is 150 ft<sup>2</sup>. This shows that the gate area was not flowing full.

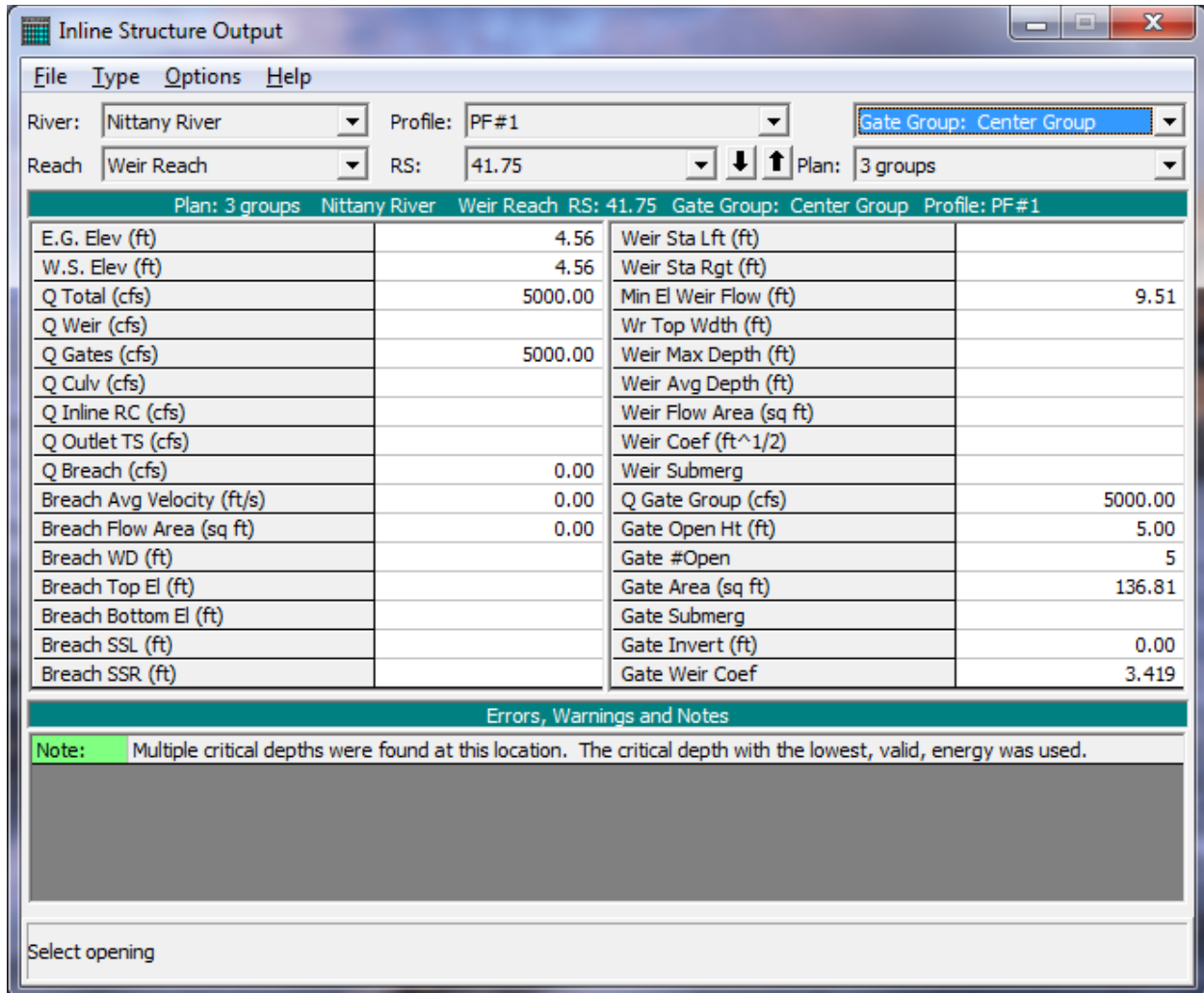

Figure 12-14: Inline Structure Output Table for Profile 1

To review the data for the second profile, the down arrow for the *Profile* field was depressed and "PF#2" was selected. The **Inline Structure Type Detailed Output Table** for profile 2 is shown in Figure 12.15. For this profile for the Center Group, 5 gates were set to an opening height of 5 feet, as before (as shown in the right column of the table). With an invert at 0 and an opening height of 5, the top of the gate openings were at an elevation of 5.00 feet. The upstream water surface elevation is shown to be at 4.05 feet, which is above the top of the gate openings. Additionally, the *Gate Area* field shows a flow area of 121.45 ft<sup>2</sup> (for each gate opening). This equals the gate opening area (4.05 ft high x 30 feet wide) in which water was flowing. The depth of flow (as measured from the invert of the gate) was 4.05 feet, which is less than the gate opening height. Therefore, the flow was still being computed as weir flow.

Plan: 3 groups Nittany River Weir Reach RS: 41.75 Gate Group: Center Group Profile: PF#2			
E.G. Elev (ft)	4.06	Weir Sta Lft (ft)	
W.S. Elev (ft)	4.05	Weir Sta Rgt (ft)	
Q Total (cfs)	10000.00	Min El Weir Flow (ft)	9.51
Q Weir (cfs)		Wr Top Wdth (ft)	
Q Gates (cfs)	10000.00	Weir Max Depth (ft)	
Q Culv (cfs)		Weir Avg Depth (ft)	
Q Inline RC (cfs)		Weir Flow Area (sq ft)	
Q Outlet TS (cfs)		Weir Coef (ft <sup>1/2</sup> )	
Q Breach (cfs)	0.00	Weir Submerg	
Breach Avg Velocity (ft/s)	0.00	Q Gate Group (cfs)	4149.93
Breach Flow Area (sq ft)	0.00	Gate Open Ht (ft)	5.00
Breach WD (ft)		Gate #Open	5
Breach Top El (ft)		Gate Area (sq ft)	121.45
Breach Bottom El (ft)		Gate Submerg	
Breach SSL (ft)		Gate Invert (ft)	0.00
Breach SSR (ft)		Gate Weir Coef	3.381

**Errors, Warnings and Notes**

**Note:** Multiple critical depths were found at this location. The critical depth with the lowest, valid, energy was used.

Select Profile

Figure 12-15: Inline Structure Output Table for Profile 2

Additionally, for the second profile, the Left and Right Gate Groups were each set to have 2 gates open, at a height of 3 feet. By depressing the arrow for the *Gate ID* field, the Left (or Right) group can be selected. For this group, gate-controlled flow occurred through the gate openings because the top of the gate openings were at an elevation of 3 feet. The field *Gate Q Total* shows that 2926.11 cfs was the total flow through the gate openings. Since the Left and Right groups had the same gate settings, the total flow in the cross section was 2 times the flow in the Left Group plus the flow in the Center Group =  $2(2925.04) + 4149.93 = 10000$  cfs, the total flow rate for the second profile.

Similarly, for the remaining profiles, the flows through the gate openings can be reviewed by pressing the down arrow next to the Profile: box. The **Weir Type Detailed Output Table** for profile 7 is shown in Figure 12.16. For this profile, the weir flow data is shown on the left side of the table, based on the data as entered in the **Inline Structure Station Elevation Data Editor** (Figure 12.4). The total weir flow is shown to be 36229.06 cfs. Because the Left, Center, and Right Gate Groups were entered with the same gate settings, the total flow in the cross section is  $3(12923.65) + 36229.06 = 75,000$  cfs, the total flow for the profile. The table also displays other weir data such as the left and right station, average depth, and submergence.

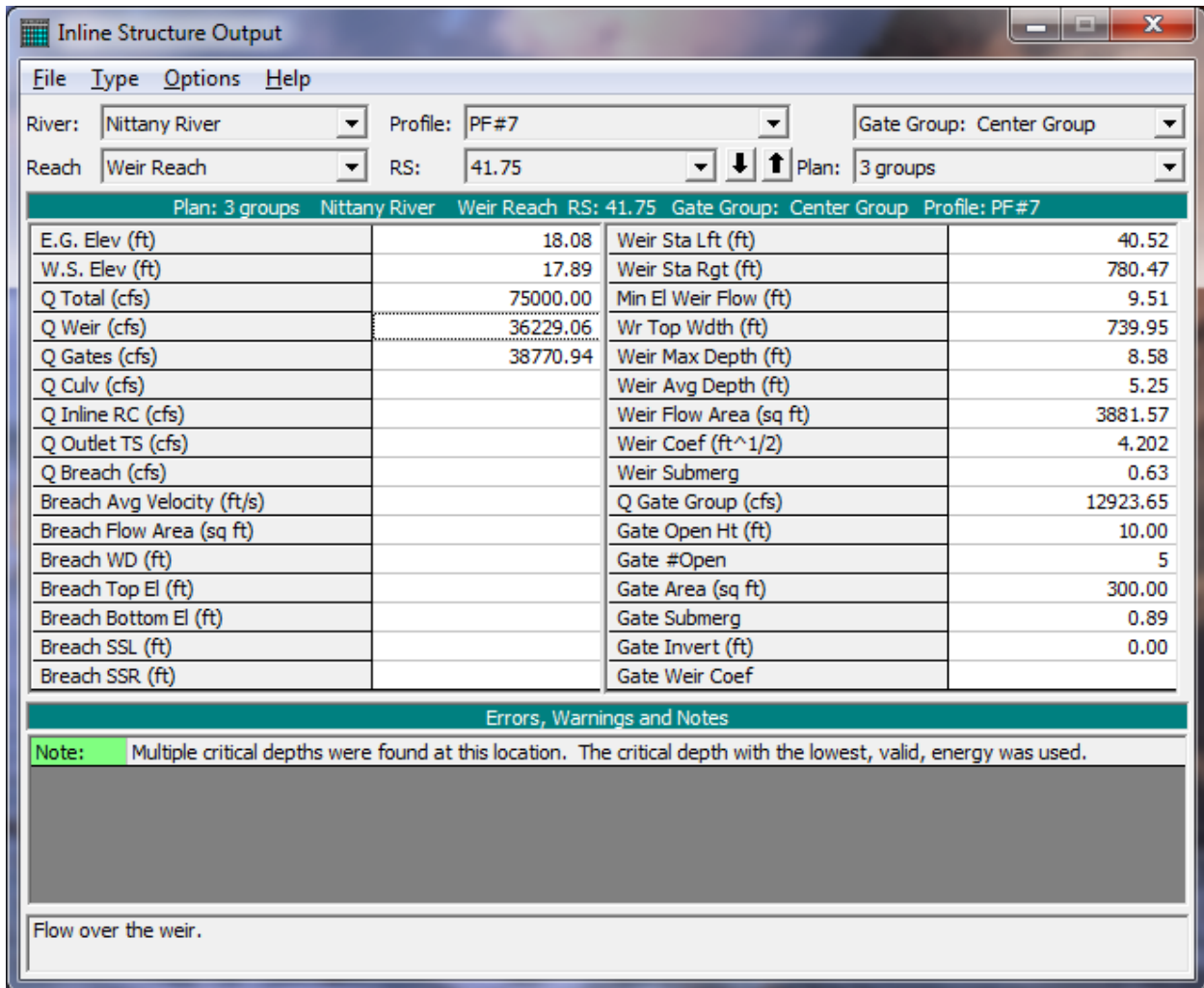

Figure 12-16: Inline Structure Output Table for Profile 7

### Inline Structure Profile Summary Table

Finally, the **Inline Structure Profile Summary Table** is shown in Figure 12.17. This figure was activated from the main program window by selecting **View, Profile Table, Std. Tables**, and then **Inline Structure**. The figure displays the water surface elevations, energy grade line, and total weir and gate flows for each of the profiles. This table shows that weir flow only occurred for the last two profiles, and can be used to assist in the determination of the gate settings to adjust the amount of weir flow and gate flow.

Reach	River Sta	Profile	E.G. Elev (ft)	W.S. Elev (ft)	Q Total (cfs)	Q Weir (cfs)	Q Gates (cfs)	Q Culv (cfs)	Q Inline RC (cfs)	Q Outlet TS (cfs)
Weir Reach	41.75	PF#1	4.56	4.56	5000.00		5000.00			
Weir Reach	41.75	PF#2	4.06	4.05	10000.00		10000.00			
Weir Reach	41.75	PF#3	6.17	6.12	20000.00		20000.00			
Weir Reach	41.75	PF#4	7.34	7.24	30000.00		30000.00			
Weir Reach	41.75	PF#5	9.86	9.76	40000.00	90.29	39909.71			
Weir Reach	41.75	PF#6	13.29	13.17	50000.00	3905.80	46094.20			
Weir Reach	41.75	PF#7	18.08	17.89	75000.00	36229.06	38770.94			

Energy gradeline for given WSEL.

Figure 12-17: Inline Structure Profile Table

## Summary

This example computed 7 flow profiles for the reach of Nittany River, which included an inline weir and spillway. The gates for the inline structure were divided into 3 groups, with 5 gates in each group. This provided for flexibility when setting the number of gates opened and the gate opening heights for each profile because the opening heights must be the same for all of the gates opened in each gate group.

By reviewing the water surface profiles and the inline structure tables, the user can determine the type of flow through the gate openings and determine if adjustments to the gate settings are required to provide for a selected water surface elevation. The **Inline Structure Output** table provides detailed output for each gate group, for any profile. The **Profile Summary Output Table - Inline Structure** provides upstream energy and water surface elevations along with the total weir and gate flow. For the maximum discharge profile, the entire weir profile is overflowing, a condition that may not be structurally sound.

## CHAPTER 13

# Bogue Chitto - Single Bridge (WSPRO)

### Purpose

This example demonstrates the use of HEC-RAS to analyze a river reach that contains a single bridge crossing. The river for this example is a section of Bogue Chitto located near Johnston Station, Mississippi. The bridge crossing is located along a county road, near the middle of the river reach.

The field data for this example were obtained from the United States Geological Survey (USGS) Hydrologic Atlas No. HA-591. This atlas is one part of a series developed to provide data to support hydraulic modeling of flow at highway crossings in complex hydrologic and geographic settings. The bridge, cross section geometry, and high water flow data were used to evaluate two flood flows. The first flood had a peak discharge of 25000 cfs and occurred on December 7, 1971, constituting a recurrence interval of 50 years. The second event had a peak discharge of 31500 cfs and occurred on March 25, 1973, with a recurrence interval greater than 100 years. It should be noted that modelers typically do not have access to high water marks and actual field flow measurements at bridges during the peak events. However, for this example, since the observed peak water surface elevations were available, they were compared to the output from HEC-RAS.

For this analysis, the water surface profiles were determined by using the WSPRO [FHWA, 1990] routine, which is an available low flow bridge hydraulics method in the HEC-RAS program. This example will focus upon the entering of data and review of the output for a bridge analysis using the WSPRO method. The user should be familiar with entering bridge data, as performed for Example 2. The user is referred to Chapter 5 of the **Hydraulic Reference Manual** and to Chapter 6 of the **User's Manual** for additional discussion concerning bridge analyses.

To review the data files for this example, from the main HEC-RAS window, select **File** and then **Open Project**. Go to the directory in which you have installed the HEC-RAS example data sets. From the "Applications Guide\Chapter 13 – Single Bridge (WSPRO)" subdirectory, select the project labeled "Bogue Chitto, MS - Example 13." This will open the project and activate the following files:

Plan:	"WSPRO Bridge Analysis"
Geometry:	"Bridge Crossing near Johnston Station"
Flow:	"50 and 100 year flows"

## Geometric Data

The geometric data for this example consists of the river system schematic, cross section data, cross section placement, bridge geometric data, ineffective flow areas, and the bridge modeling approach. Each of these items are discussed below.

### River System Schematic

To view the river system schematic, from the main program window select **Edit** and then **Geometric Data**. This will activate the **Geometric Data Editor** and the screen will display the schematic, as shown in Figure 13.1. For this example, the river system is composed of one river and only one reach. The river is labeled "Bogue Chitto" and the river reach is "Johnston Sta." The river system was defined initially with 11 cross sections beginning at river mile 50.00 as the downstream cross section and river mile 56.97 as the upstream cross section. The initial cross section data were obtained from the USGS Atlas, and cross sections were interpolated along the river reach to provide additional cross section data.

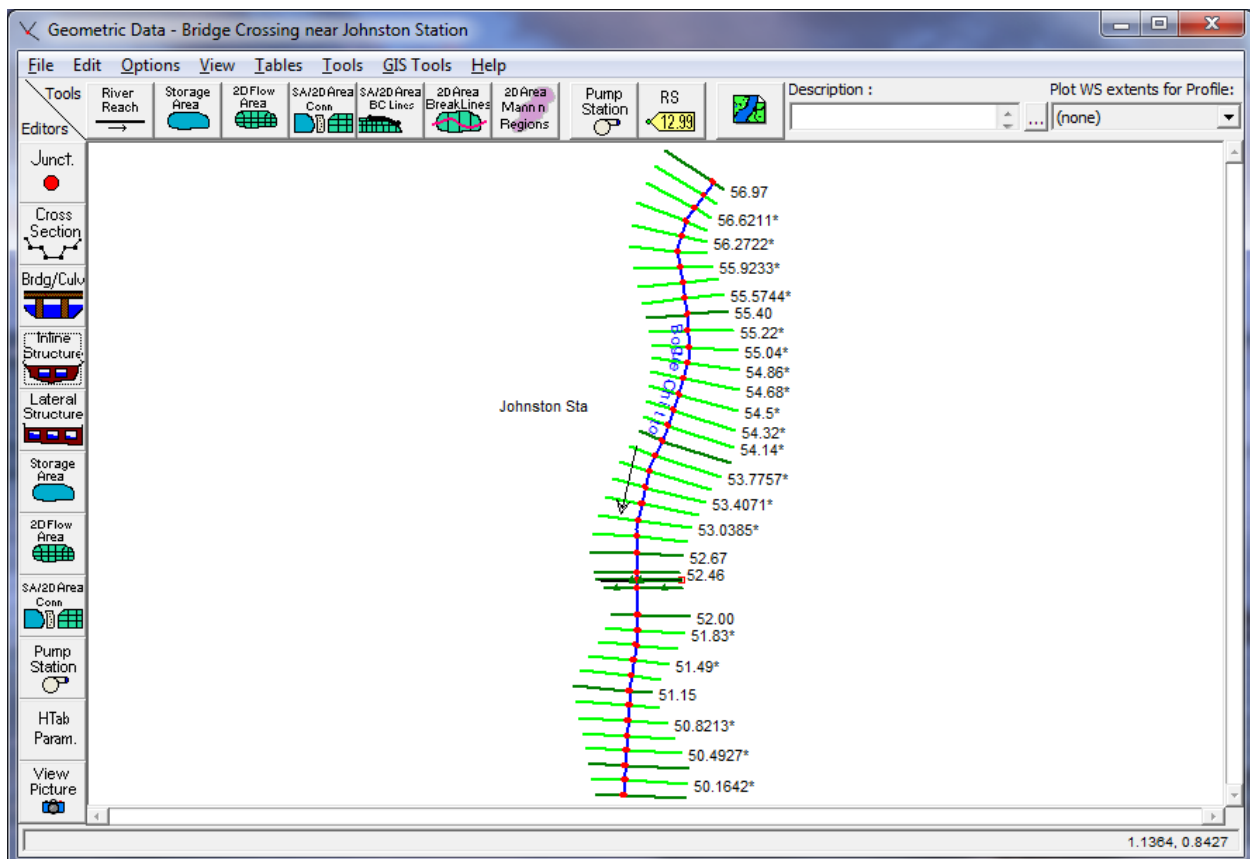

Figure 13-1: River System Schematic

The editing commands of **Add Points to a Reach** and **Move Object** were used to curve the river system schematic. This was performed for aesthetic purposes only, and does not effect the hydraulic computations.



### Cross Section Geometric Data

To enter the cross section data, the **Cross Section** icon on the left side of the **Geometric Data Editor** was selected. This activated the **Cross Section Data Editor**, as shown in Figure 13.2. Then, **Add a new cross section** was selected under the **Options** menu to create each new cross section. For each cross section, the geometric data consisted of the: description, X-Y coordinates, reach lengths, Manning's n values, main channel bank stations, and contraction and expansion coefficients. (Note: The ineffective flow areas will be discussed in a subsequent section.)

Manning's n values, and main channel bank stations were obtained from the field data displayed on the USGS atlas. A summary table of the reach lengths, Manning's n values, or contraction and expansion coefficients for the cross sections can be seen by selecting the relevant listing under the Tables menu on the **Geometric Data Editor**. The summary table of the reach lengths for the cross sections is shown in Figure 13.3.

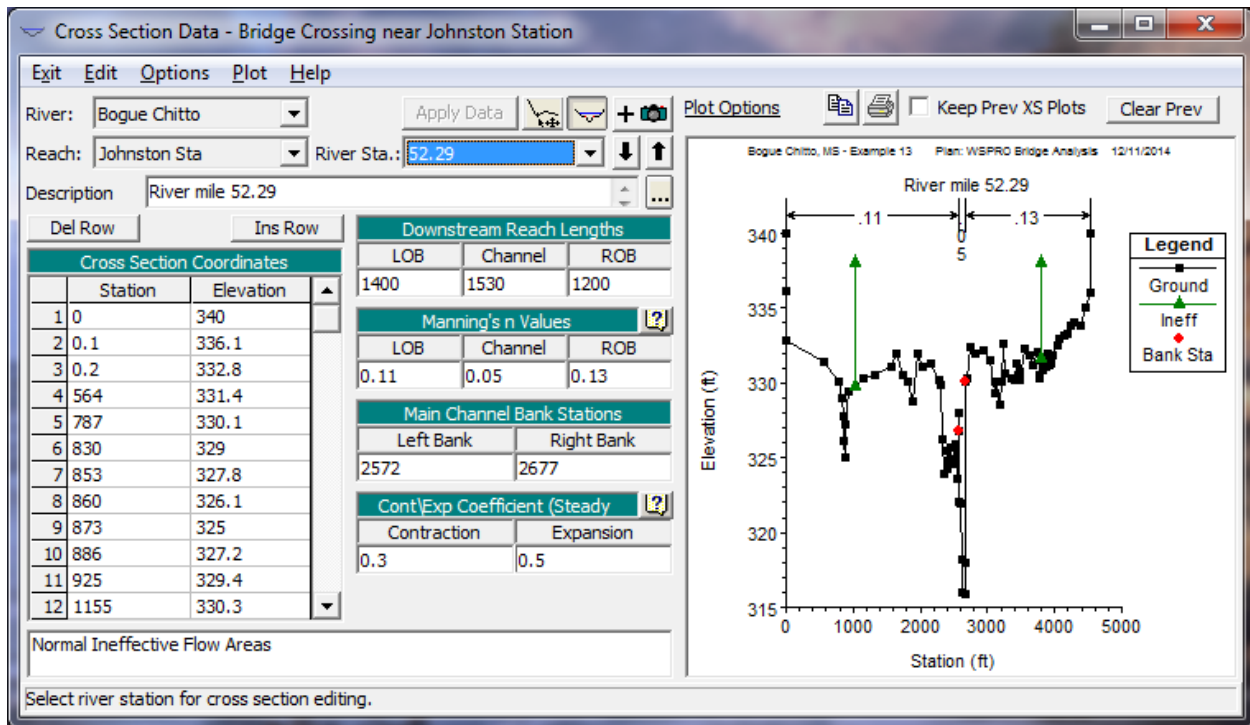

Figure 13-2: Cross Section Data Editor for River Station 52.29

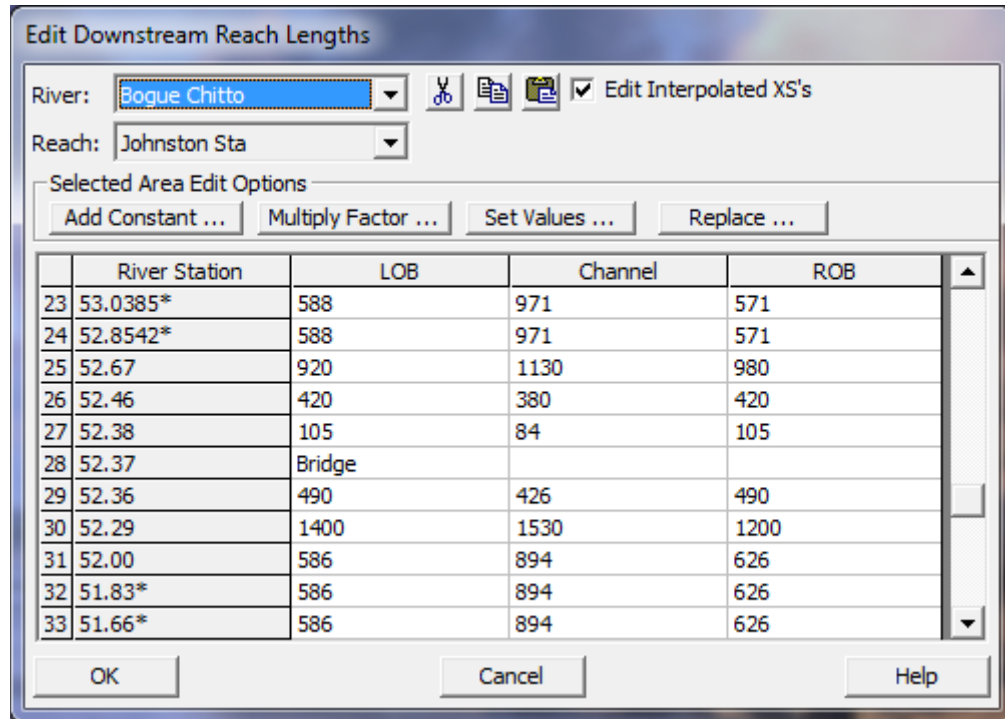

Figure 13-3: Reach Lengths for Bogue Chitto

## Cross Section Placement

The reach lengths, as shown in Figure 13.3, determine the placement of the cross sections. The placement of the cross sections relative to the location of the bridge is crucial for accurate prediction of expansion and contraction losses. The bridge routine utilizes four cross sections to determine the energy losses through the bridge. (Additionally the program will interpret two cross sections inside of the bridge by superimposing the bridge data onto both the immediate downstream and upstream cross sections from the bridge.) The following is a brief summary for the initial estimation of the placement of the four cross sections. The modeler should review the discussion in Chapter 6 of the **User's Manual** and Chapter 5 of the **Hydraulic Reference Manual** for further detail.

**First Cross Section.** Ideally, the first cross section should be located sufficiently downstream from the bridge so that the flow is not affected by the structure (i.e., the flow has fully expanded). This distance (the expansion reach length) should generally be determined by field investigation during high flows and will vary depending on the degree of constriction, the shape of the constriction, the magnitude of the flow, and the velocity of the flow. In order to provide better guidance to determine the location of the fully expanded cross section, a study was performed by the Hydrologic Engineering Center [HEC-1995]. This study focused on determining the expansion reach length, the contraction reach length, and the expansion and contraction energy loss coefficients. The results of the study are summarized in **Appendix B** of the **Hydraulic Reference Manual**.

To determine an initial estimate of the expansion reach length, the following information was required:

$$b = 450 \text{ ft}$$

$$B = 5000 \text{ ft}$$

$$b/B = 0.1$$

$$S = (25.7 \text{ ft}) / (36790 \text{ ft}) \cdot (5280 \text{ ft} / \text{mi}) = 3.7 \text{ ft} / \text{mi}$$

$$n_{ob} / n_{ch} = (0.13) / (0.05) = 2.6$$

$$L_{obs} = 1770 \text{ ft}$$

- where:
- b = bridge opening width
  - B = total floodplain width
  - S = slope
  - $n_{ob}$  = Manning's n value for the overbank
  - $n_{ch}$  = Manning's n value for the main channel
  - $L_{obs}$  = average length of the side obstructions

With the above information, an initial estimate of the expansion reach length ( $L_e$ ) was obtained by using the table values in **Appendix B** of the **Hydraulic Reference Manual**. From Table B.1, an average value of the expansion ratio (ER) was 1.2. Using this value, the expansion reach length is:

$$L_e = (ER)(L_{obs}) = (1.2)(1770 \text{ ft}) = 2120 \text{ ft}$$

From the reach lengths table (Figure 13.3), the distance from cross section 52.36 to 52.00 is 1956 feet (= 426 + 1530). Therefore, cross section 52.00 was initially considered as the cross section of fully expanded flow. Since cross section 52.29 is in the zone of flow expansion, ineffective flow areas were placed in the overbank areas. This will be discussed further during the determination of the ineffective flow areas.

After the steady flow analysis was performed, the expansion reach length was evaluated using regression equations that are presented in the HEC study [HEC-1995]. The equations require flow parameters at the initially chosen location and cannot be evaluated until after the steady flow analysis is performed. These procedures will be described near the end of this example.

Second Cross Section. The second cross section used by the program to analyze the energy losses through the bridge is located a short distance downstream of the structure. This section should be very close to the bridge and reflect the effective flow area on the downstream side of the bridge. For this example, a roadway embankment sloped gradually from the roadway decking on both sides of the roadway. Cross section 52.36 was located at the toe of the roadway embankment and was used to represent the effective flow area on the downstream side of the bridge opening. The program will

superimpose the bridge geometry onto this cross section to develop a cross section inside the bridge at the downstream end.

Third Cross Section. The third cross section is located a short distance upstream from the bridge and should reflect the length required for the abrupt acceleration and contraction of the flow that occurs in the immediate area of the opening. As for the previous cross section, this cross section should also exhibit the effective flow areas on the upstream side of the bridge. For this example, cross section 52.38 was located at the toe of the roadway embankment on the upstream side of the bridge. Similar to the previous cross section, the program will superimpose the bridge geometry onto this cross section to develop a cross section inside the bridge at the upstream end.

Fourth Cross Section. The fourth cross section is located upstream from the bridge where the flow lines are parallel and the cross section exhibits fully effective flow. To determine an initial estimate of the contraction reach length ( $L_c$ ), a value of the contraction ratio (CR) was obtained as 0.8 from Table B.2, **Appendix B** of the **Hydraulic Reference Manual**. This yields a contraction reach length of:

$$L_c = (CR)(L_{obs}) = (0.8)(1770\text{ft}) = 1400\text{ft}$$

From the reach lengths table (Figure 13.3), the distance from cross section 52.46 to 52.38 is 380 feet. For this example, cross section 52.46 was initially used as the section where the flow lines were parallel. After the steady flow analysis, the location of this cross section was evaluated using the procedures as outlined in the recent HEC study [HEC-1995]. This evaluation will be presented in the discussion near the end of this example.

Additionally, the HEC study [HEC-1995] provided guidance to determine the expansion and contraction coefficients. The contraction and expansion coefficients are used by the program to determine the transition energy losses between two adjacent cross sections. From the data provided by the recent HEC study [HEC-1995], gradual transition contraction and expansion coefficients are 0.1 and 0.3, and typical bridge contraction and expansion coefficients are 0.3 and 0.5, respectively. For situations near bridges where abrupt changes are occurring, the coefficients may take larger values of 0.5 and 0.8 for contractions and expansions, respectively. A listing of the selected values for the river reach can be viewed by selecting **Tables** and then **Coefficients** from the **Geometric Data Editor**. This table is shown in Figure 13.4 and displays the values selected for the river cross sections. Typical gradual transition values were selected for stations away from the bridge. However, near the bridge section, the coefficients were increased to 0.3 and 0.5 to represent greater energy losses. For additional discussion concerning contraction and expansion coefficients at bridges, refer to Chapter 5 of the **Hydraulic Reference Manual**. After the steady flow analysis, the selection of the coefficients were evaluated and will be discussed near the end of this example.

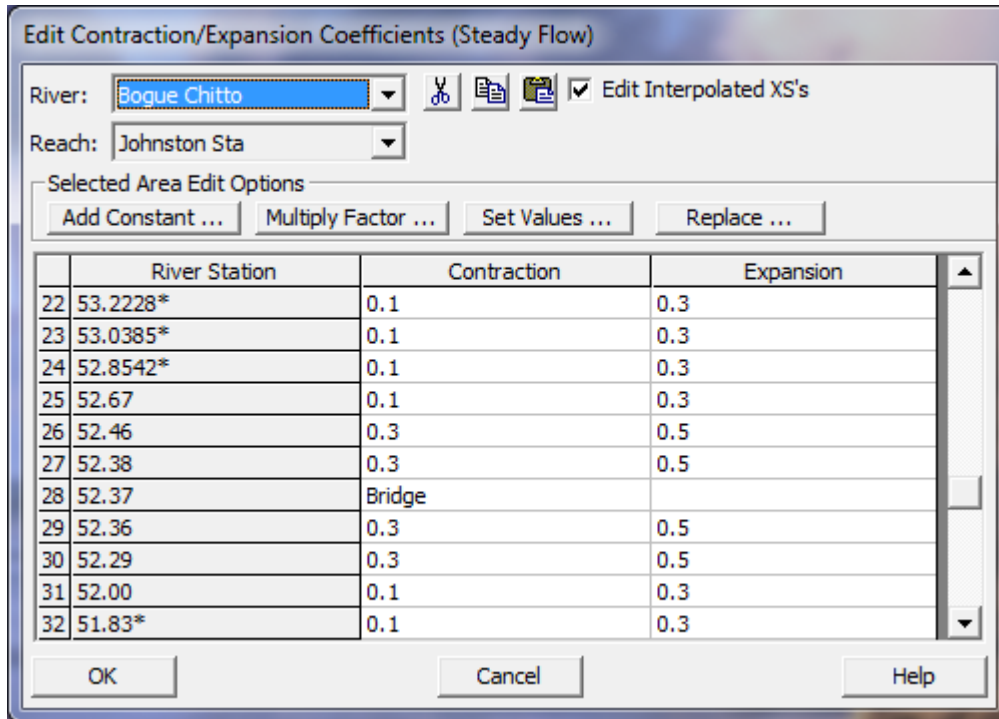

Figure 13-4: Contraction and Expansion Coefficients

This completed the input for the cross section geometric data. Next, the bridge geometry data was entered as outlined in the proceeding section.

### Bridge Geometry Data

To perform the hydraulic analysis, the bridge geometry was entered next. This section provides a brief summary of the input for the bridge geometry including the bridge deck/roadway, sloping abutments, and bridge piers.

**Bridge Deck and Roadway Geometry.** From the **Geometric Data Editor**, select the **Bridge/Culvert** icon. To create the bridge cross sections, the river was selected as "Bogue Chitto," the reach was "Johnston Sta," and then **Options** and **Add a Bridge and/or Culvert** were selected. The bridge river station was then entered as 52.37. Next, the data for the bridge deck were entered. The **Deck/Roadway** icon was selected and the **Deck/Roadway Data Editor** appeared as shown in Figure 13.5.

Upstream			Downstream			
	Station	high chord	low chord	Station	high chord	low chord
1	0.	341.	0.	0.	341.	0.
2	2444.	341.	0.	2444.	341.	0.
3	2444.	341.	340.2	2444.	341.	340.2
4	2864.	341.	340.2	2864.	341.	340.2
5	2864.	341.	0.	2864.	341.	0.
6	5000.	341.	0.	5000.	341.	0.
7						
8						

Figure 13-5: Deck/Roadway Data Editor

The first input at the top of the editor is the distance from the upstream side of the bridge deck to the cross section immediately upstream from the bridge (cross section 52.38). This distance was determined to be 26 feet from the USGS atlas. In the next field, the bridge deck width of 31 feet was entered. This is a total distance of  $31 + 26 = 57$  feet. From the reach lengths table (Figure 13.3), the distance from cross section 52.38 to 52.36 is 84 feet. This leaves  $84 - 57 = 27$  feet from the downstream side of the bridge deck to cross-section 52.36. Finally, at the top of the **Deck/Roadway Data Editor**, a weir flow coefficient of 2.6 was selected for the analysis.

The central section of the **Deck/Roadway Editor** is comprised of columns for input of the station, high cord elevation, and low cord elevation for both the upstream and downstream sides of the bridge deck. The data were entered from left to right in cross section stationing and the area between the high and low cord comprised the bridge structure. The stationing of the upstream side of the deck was based on the stationing of the cross section located immediately upstream. Likewise, the stationing of the downstream side of the deck was based on the stationing of the cross section placed immediately downstream. If both the upstream and downstream data are identical, the user needs only to input the upstream data and then select **Copy Up to Down** to enter the downstream data.

As a final note, the low cord elevations that are concurrent with the ground elevation were entered as a value lower than the ground elevation. The program will automatically clip off and remove the deck/roadway area below the ground. For example, at station 0, a low cord elevation of 0 feet was

entered. However, the actual ground elevation at this point is approximately 340 feet. Therefore, the program will automatically remove the area of the roadway below the ground. Additionally, the last station was entered as a value of 5000 feet. This stationing ensured that the roadway and decking extended into the limits of the cross section geometry. As described previously, the program will clip off the area beyond the limits of the cross section geometry.

Below the deck station and elevation data, there are two fields to enter the upstream and downstream embankment side slopes. These values are used by the WSPRO bridge analysis method and for graphical representation on the profile plot. For this example, values of 2.0 (horizontal to 1 vertical) were entered for both the **US Embankment SS** and **DS Embankment SS**, as measured from the USGS Atlas.

At the bottom of the **Deck\Roadway Data Editor**, there are three additional fields for data entry. The first is the Max **Allowable Submergence**. This input is a ratio of downstream water surface to upstream energy, as measured above the minimum weir elevation. When the ratio is exceeded, the program will no longer consider the bridge deck to act as a weir and will switch the computation mode to the energy (standard step) method. For this example, the default value of 0.95 (95 %) was selected.

The second field at the bottom of the editor is the **Min Weir Flow Elevation**. This is the elevation that determines when weir flow will start to occur over the bridge. If this field is left blank (as for this example), the program will default to use the lowest high cord value on the upstream side of the bridge. Finally, the last field at the bottom of the editor is the selection of the weir flow submergence method. This method will determine the reduction of the weir flow coefficient due to submergence. For this example, a broad crested weir flow submergence method was selected. Upon entering all of the above data, the **OK** button was selected to exit the **Deck/Roadway Data Editor**.

**Bridge Pier Geometry.** To enter the pier data, the **Pier** icon was selected from the **Bridge/Culvert Data Editor**. This resulted in the display shown in Figure 13.6. The modeler should not include the piers as part of the ground or bridge deck/roadway because pier-loss equations use the separate bridge pier data during the computations.

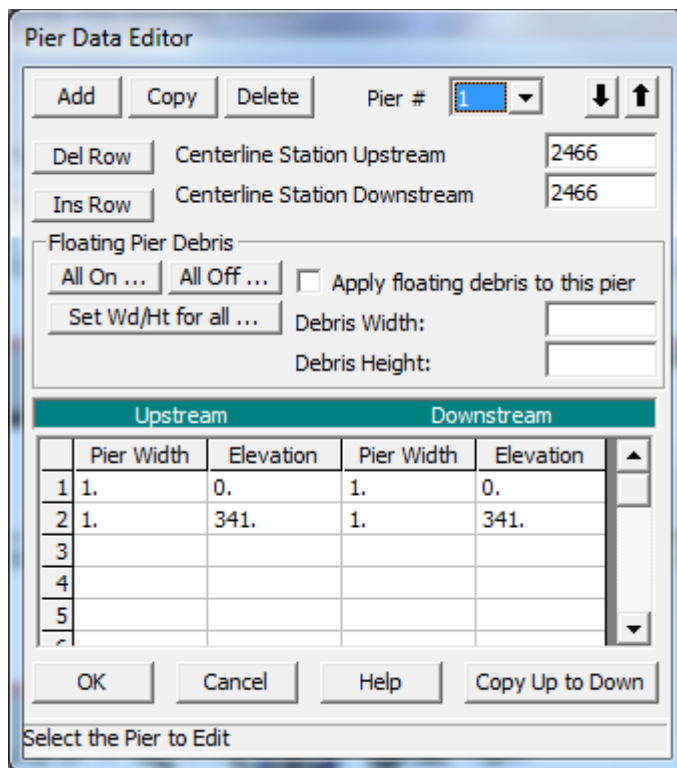

Figure 13-6: Bridge Pier Data Editor

The program will establish the first pier as pier number 1. As shown in Figure 13.6, the upstream and downstream stations were entered for the centerline of the first pier. The upstream and downstream stations were based on the geometry of the cross sections located immediately upstream (cross section 52.38) and immediately downstream (cross section 52.36) of the bridge. The user needs to be cautious placing the pier centerline stations because the X-coordinates for the upstream and downstream cross section stationing may be different. This is to ensure that the piers “line up” to form the correct geometry. For this example, the 17 piers are placed 24 feet on center, with centerline stationing from 2466 to 2850. The piers are 1 foot wide for their entire height. The starting elevation is set below the ground, and the ending elevation is inside the bridge decking. With these elevations, the program will “clip off” the excess pier heights. After entering the data, the **OK** button was selected.

**Sloping Abutments.** The next icon on the left side of the **Bridge/Culvert Data Editor** is **Sloping Abutment**. This icon was selected to enter the abutment data, and is shown in Figure 13.7 for the first (left) abutment. The user can view the data for the second (right) abutment by selecting the down arrow on the **Sloping Abutment Data Editor** in the HEC-RAS program. After the data were entered, the **OK** button was selected to exit the editor and the schematic of the bridge/deck, piers, and abutments was displayed as is shown in Figure 13.8. (Note: The figure in the text displays the ineffective flow areas that will be added in the next section.)



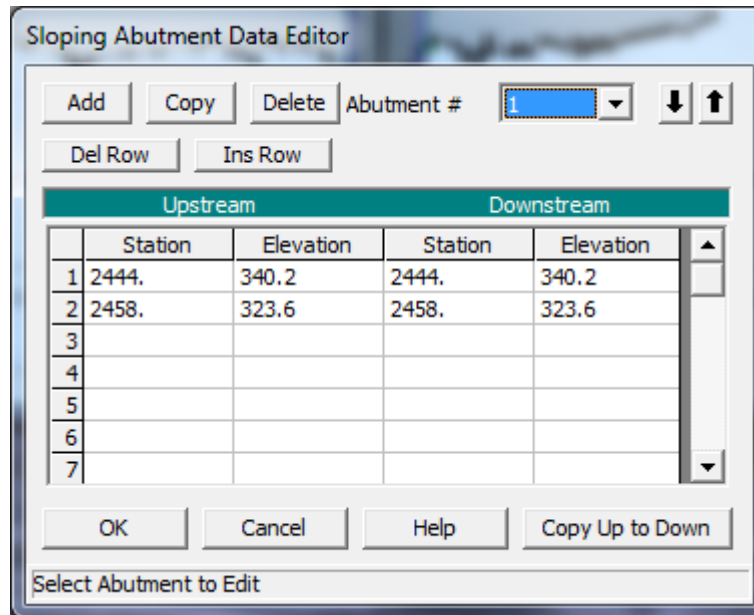

Figure 13-7: Sloping Abutment Data Editor

The cross sections shown in Figure 13.8 are developed by superimposing the bridge data on the cross sections immediately upstream (52.38) and immediately downstream (52.36) of the bridge. The top cross section in Figure 13.8 reflects the geometry immediately inside the bridge on the upstream side and the bottom cross section reflects the geometry immediately inside the bridge on the downstream side.

While viewing the bridge, the modeler can select to view just the upstream, just the downstream, or both of the cross section views. This is performed by selecting **View** and then the required option. Additionally, from the **View** menu, the user should select **Highlight Weir, Opening Lid and Ground** as well as **Highlight Piers**. These options enable the modeler to view what the program will consider as the weir length, bridge opening, and pier locations. Any errors in the data will appear as inconsistent images with these options. Also, the zoom-in option will allow the user to examine data details. Finally, the **Apply Data** button was selected to accept the data. (Note: To save the data to the hard disk, the user must select **Save Geometry Data** under the **File** menu on the **Geometric Data Editor**).

### Ineffective Flow Areas

As a final step for the bridge geometry, any ineffective flow areas that existed due to the bridge (or any other obstruction) were entered. Ineffective flow is used to define an area of the cross section in which the water will accumulate but is not being actively conveyed. At a bridge, ineffective flow areas normally occur just upstream and downstream of the road embankment, away from the bridge opening.

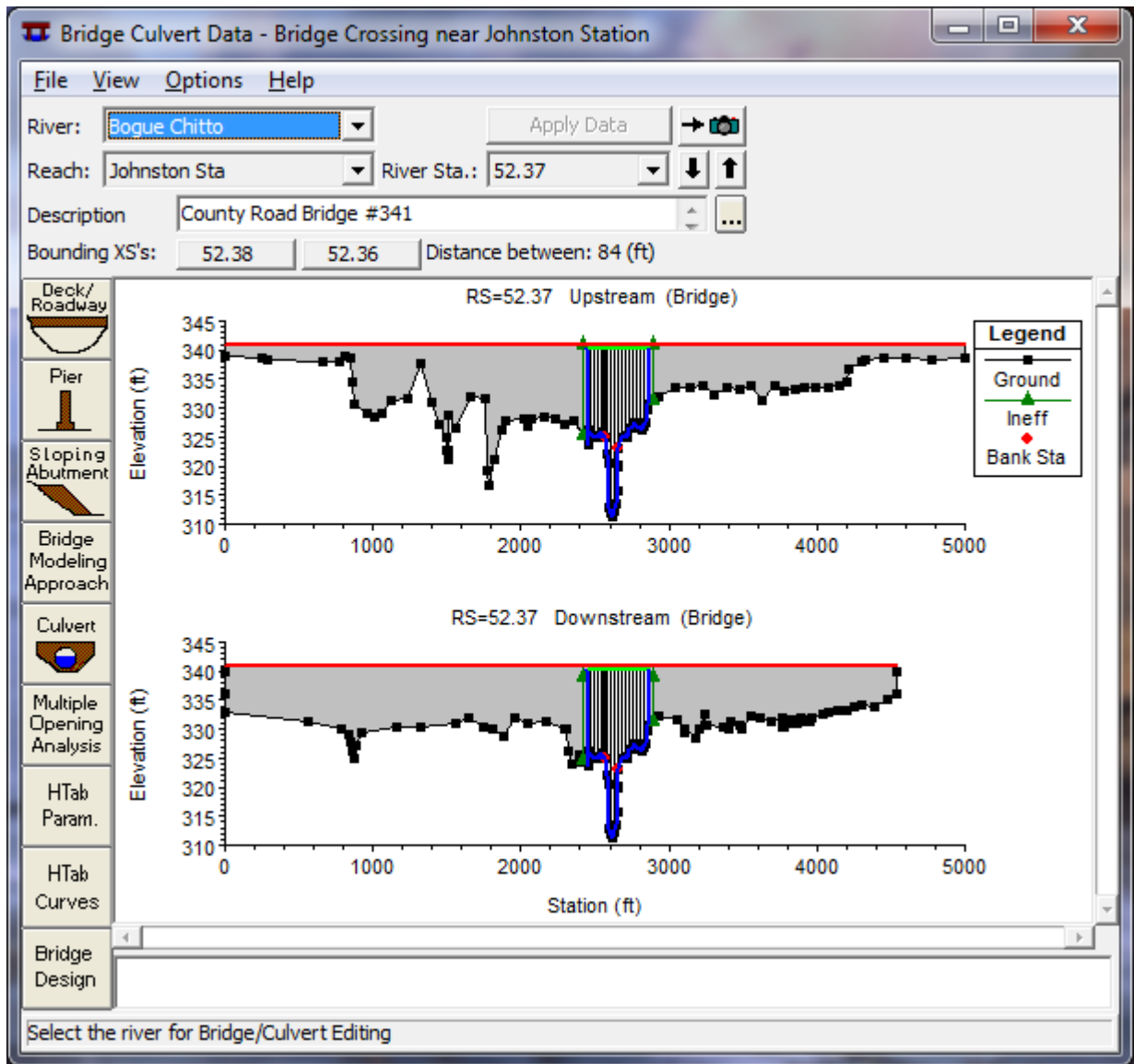

Figure 13-8: Bridge/Culvert Data Editor for County Road Bridge #341

For this example, ineffective flow areas were included on both the upstream cross section (52.38) and the downstream cross section (52.36), as well as on cross section 52.29 (the cross section in the expansion reach). To determine an initial estimate for the stationing of the ineffective flow areas on either side of the bridge, a 1:1 ratio of the distance from the bridge to the cross section was used. For this example, cross section 52.38 is located 26 feet upstream of the bridge. Therefore, the left and right ineffective flow areas were set to start at 26 feet to the left and right of the bridge opening. The left side of the bridge opening is at station 2444, which leads to a left ineffective station of  $2444 - 26 = 2418$ . The right side of the bridge opening is at station 2864, which leads to a right ineffective flow station of  $2864 + 26 = 2890$ . Similarly, cross section 52.36 is located 27 feet downstream from the bridge and the ineffective flow areas at this cross section were set at 27 feet to the left and right of the bridge opening, at stations of  $2417 (= 2444 - 27)$  and  $2891 (= 2864 + 27)$ , respectively.

The initial elevation of the ineffective flow areas for the upstream cross section was chosen as 340.8, a value slightly lower than the lowest high cord elevation (341.0). This ineffective flow elevation was chosen so that when the water surface becomes greater than this ineffective elevation, the flow would most likely be weir flow and would be considered as effective flow.

At the downstream cross section, the elevation of the ineffective flow area was set to be 339.0, slightly lower than the low cord elevation (340.2). This elevation was chosen so that when weir flow occurs over the bridge, the water level downstream may be lower than the low cord, but yet it will contribute to the active flow area.

The ineffective flow areas were entered by first selecting the **Cross Section** icon from the **Geometric Data Editor**. Then, **Options** and **Ineffective Flow Areas** were chosen for cross section 52.38 and then for cross section 52.36. The ineffective stations and elevations as previously determined were entered, as shown in Figure 13.9 for cross section 52.38.

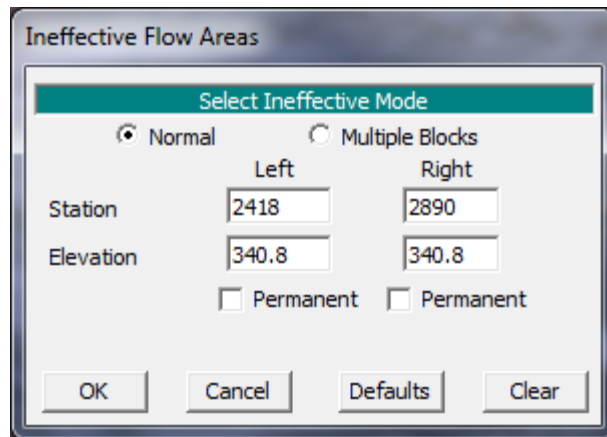

Figure 13-9: Normal Ineffective Flow Areas for Cross Section 52.38

Since the "Normal" type of ineffective flow was chosen, these entries imply that all the water to the left of the left station and to the right of the right station will be considered as ineffective flow until the water level exceeds the elevation of 340.8 feet.

Cross section 52.29 is in the area of expanding flow and therefore only a portion of the cross sectional flow will be effective. A "Normal" type of ineffective flow areas were set at stations 1030 and 3800, both at an elevation of 338. These stations were determined by taking into account the distance of cross section 52.29 from the bridge (426 feet), as compared to the total distance of the expansion reach length (1956 feet). With these distances, cross section 52.29 is located approximately 25% ( $= 426 / 1956 * 100\%$ ) down the expansion reach length. As the flow exits the bridge opening, it will initially expand at a greater rate than it will farther downstream. An initial estimate of the degree of expansion was assumed to be approximately 60% at cross section 52.29. Therefore, 60% of the left overbank width was subtracted from the left main channel bank station to determine the left ineffective flow station. Similarly, 60% of the right overbank width was added to the right main channel bank station to determine the right ineffective flow station. The elevation of 338 was chosen to be greater than the water surface elevations.

The **OK** button was selected and then **Apply Data** was chosen to accept the data. The ineffective flow areas then appeared as triangles, as shown previously on Figure 13.8 for the bridge cross-sections. Additionally, the ineffective flow areas will appear on the cross sections plots. Finally, a note will appear in the box at the bottom of the **Cross Section Data Editor** that states an ineffective flow exists for each cross section that this option was selected for, as shown in Figure 13.2. The ineffective flow areas could have been entered previously along with the discussion of the cross section data (X-Y coordinates, reach lengths, etc.). However, it is often easier to enter the bridge data first and then the ineffective flow data to easily determine where the ineffective flow stations should be located. After the steady flow analysis was performed, the ineffective flow areas were evaluated to determine if they were placed appropriately. This will be discussed near the end of this example.

### **Bridge Modeling Approach**

The bridge routines in HEC-RAS allow the modeler to analyze the bridge flows by using different methods with the same geometry. The different methods are: low flow, high flow, and combination flow. Low flow occurs when the water flows only through the bridge opening and is considered as open channel flow (i.e., the water surface does not exceed the highest point of the low cord of the bridge). High flow occurs when the water surface encounters the highest point of the low cord of the bridge. Finally, combination flow occurs when both low flow or pressure flow occur simultaneously with flow over the bridge. The modeler needs to select appropriate methods for both the low flow and for the high flow methods. For the combination flow, the program will use the methods selected for both of the flows.

From the **Geometric Data Editor**, select the **Bridge/Culvert** icon and then the **Bridge Modeling Approach** button. This will activate the **Bridge Modeling Approach Editor** as shown in Figure 13.10. For this example, there is only 1 bridge opening located at this river station and therefore the bridge number was 1. The modeler is referred to Chapter 6 of the **User's Manual** and Chapter 5 of the **Hydraulic Reference Manual** for additional discussion on the bridge modeling approach editor.

**Low Flow Methods.** The modeler needs to select which low flow methods the program should compute and which method the program should use. The modeler can select to have the program compute particular methods or all of the methods. Then, the modeler needs to select which method the program will use as a final solution. Alternatively, the modeler can select the computation of several or all of the methods, and then have the program use the method with the greatest energy loss for the final solution.

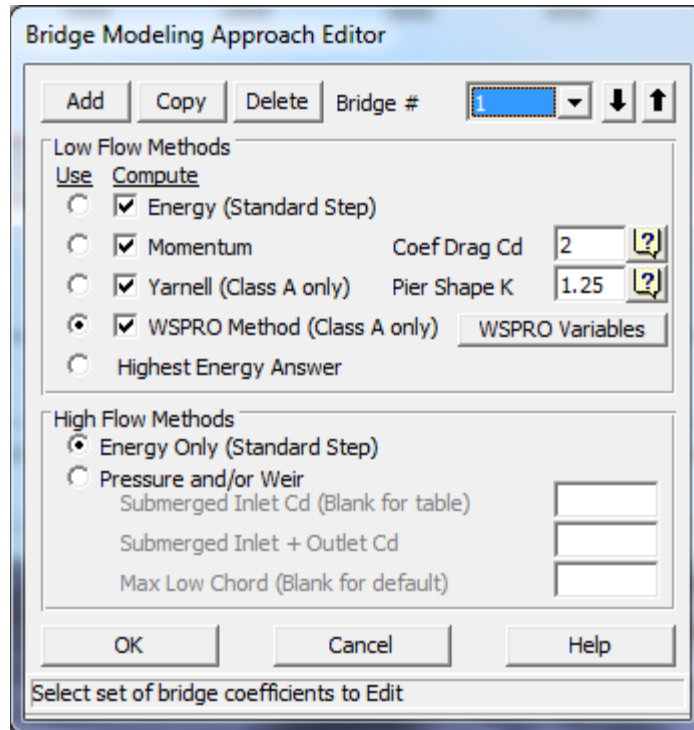

Figure 13-10: Bridge Modeling Approach Editor

For this example, all four low flow methods were selected to be computed. For the momentum method, a drag coefficient  $C_d = 2.00$  was entered for the square nose piers. For the Yarnell method, a value of  $K = 1.25$  was entered. Finally, the WSPRO method was selected to be used for the solution. The modeler is referred to Example 2 - Beaver Creek for an example application that further discusses the low flow methods of energy, momentum, and Yarnell.

For the WSPRO method, the user is required to enter additional data. This was performed by selecting the **WSPRO Variables** button from the **Bridge Modeling Approach** editor. This activated the **WSPRO Data Editor**, as shown in Figure 13.11. Most of the data entered on this editor is used to determine the "Coefficient of Discharge" for the WSPRO method. The following discussion outlines the WSPRO data that was entered for this analysis. The user is referred to Chapter 6 of the **User's Manual** and to Chapter 5 of the **Hydraulic Reference Manual** for a more detailed discussion of WSPRO method.

At the top of the editor, as shown in Figure 13.11, the value of 341 feet was entered for the left and right elevations of the top of the embankments. The elevations for the toe of the abutments were entered as 323.6 and 330.5, for the left and right abutments, respectively. Next, the abutment type was selecting as *type 3: sloping abutments and sloping embankments*. The average slope of the abutments was entered as 1 (horizontal to 1 vertical) and the top width of the embankment was entered as 31 feet. All of these values were obtained from the USGS Atlas.

Figure 13-11: WSPRO Data Editor

The *centroid stationing of projected bridge opening at the approach cross section* was entered as a value of 2531 feet. To obtain this value, the bridge opening width is projected onto the approach cross section (52.46). This projected width is situated onto the approach section such that the main channel is in the same relative position to the bridge opening width on the approach section as at the bridge opening. The width of the projecting bridge opening should embrace the flow, which could pass through the actual bridge opening without contraction. Then, the centroid of the bridge opening width on the approach section was then determined to be at a stationing of 2531.

The bottom portion of the editor is divided into four sections. The first section is to describe the **Wing Walls** on the abutments. For this example, there were no wing walls present. If wing walls were present, the user can select either "Angular" or "Rounded," by depressing the down arrow adjacent to this field. Then, the appropriate data would be entered for the angle, length and radius fields, pertaining to the type of wing wall selected.

The second section is to describe the **Guide Banks**. For this example, there were no guide banks. If guide banks were present, the options are "Straight" or "Elliptical" to describe the type and then the user would enter the appropriate dimensions of length, offset, and skew.

The third section at the bottom of the editor is *Optional Contraction and Expansion Losses*. The WSPRO method includes friction losses throughout the bridge region for the calculations. However, the only contraction or expansion loss that is included is an expansion loss from the exit section (cross section 52.29) to the cross section immediately downstream from the bridge (52.36). The user can include additional losses at the approach section (52.46), at the guide banks, at the upstream outside contracted

section (52.38), at the inside bridge upstream section (52.37 BU), and at the inside bridge downstream section (52.37 BD). For this example, there were no additional energy losses selected.

The final section of the editor is used to select options for the piers and friction slope method. If the piers are continuous, then the user should select *Piers are continuous for the width of the bridge*. This selection will determine a weighting factor in the determination of the "Coefficient of Q" discharge factor. Finally, the WSPRO method traditionally utilizes the geometric mean equation to determine the representative friction slope between two cross sections. If the Use Geometric Mean as Friction Slope Method is selected, then the program will use this method. If it is not selected, then the program will use the friction slope averaging method that has been selected by the user. (This is selected in the Steady Flow Analysis window by choosing **Options, Friction Slope Methods**, and then the appropriate choice. The default method is *Average Conveyance*. The user is referred to Chapter 7 of the **User's Manual** and to Chapter 2 of the **Hydraulic Reference Manual** for more information on friction slope methods.)

This completed the entry of the data for the WSPRO method as the low flow method. The **OK** button at the bottom of the editor was selected to exit the editor. Next, the high flow method was selected on the **Bridge Modeling Approach Editor**.

**High Flow Methods.** High flows occur when the water surface elevation upstream of the bridge is greater than the highest point on the low cord of the upstream side of the bridge. Referring to Figure 13.10, the two alternatives for the program to compute the water surface elevations during the high flows are: *Energy Only (Standard Step) or Pressure and/or Weir Flow*. The *Energy Only (Standard Step)* method regards the flow as open channel flow and considers the bridge as an obstruction to the flow. The *Pressure Flow* computations are divided into two scenarios. The first is when only the upstream side of the bridge deck is in contact with the water and the second is when the bridge constriction is flowing completely full. The program will begin to calculate either type of pressure flow when the computed low flow energy grade line is greater than the highest point of the upstream low cord. *Weir Flow* occurs when the upstream energy grade line elevation (as a default setting) exceeds the lowest point of the upstream high cord.

For this example, the high flow method was selected as energy. From the data on the USGS Atlas, the observed water surface elevations did not encounter the bridge deck, so therefore a high flow method of analysis was not anticipated. The user is referred to "Example 2 - Beaver Creek" for a bridge analysis that applied a high flow method.

At this point, all of the bridge data have been entered. The **OK** button was selected to close the **Bridge Modeling Approach Editor** and the **Apply Data** button was depressed on the **Bridge/Culvert Data Editor** before it was closed. Then, the geometry data was saved as the file "Bridge Crossing near Johnston Station" by selecting **File** and then **Save Geometry Data As** from the **Geometric Data Editor**.

As a final geometric component, a picture of the bridge has been included as a separate file. The red square on the river system schematic indicates that a picture has been added for that cross section. This picture was scanned from

the USGS Atlas and saved as the file "chit.bmp." To view this picture, the user can select the **View Picture** icon from the left side of the **Geometric Data Editor**. When river station 52.37 is selected, the picture should appear. The user is referred to Chapter 6 of the **User's Manual** for a discussion on adding and viewing pictures to the river system schematic.

## Steady Flow Data

From the main program window, select **Edit** and then **Steady Flow Data**. This will display the **Steady Flow Data Editor** shown in Figure 13.12. For this analysis on the reach of Bogue Chitto, two profiles were selected to be computed. The flow data were entered for river station 56.97 (the upstream cross section) and the flow values were 25000, and 31500 cfs. These flows will be considered continuous throughout the reach so no flow change locations were used. Additionally, the default profiles names of "PF#1 and "PF#2" were changed to "50 yr" and "100 yr," respectively. This was performed by selecting **Edit Profile Names** from the **Options** menu, and then typing in the new title.

Next, the boundary conditions were entered by selecting the **Reach Boundary Conditions** button. This resulted in the display shown in Figure 13.13. For this example, a subcritical analysis was performed. Therefore, a downstream boundary condition was required for each flow value. The type of boundary conditions were known water surface elevations, therefore, *Set boundary for one profile at a time* was selected. With this selection, the table in the central portion of the editor expanded to show two rows, one for each of the two profiles. Then, the mouse arrow was placed over the downstream field for profile one and the box was selected (highlighted). The **Known W.S.** button was chosen and the data entry box appeared that requested the water surface elevation for the first profile. A value of 325.7 feet was entered, and the procedure was repeated for profile two, with a known water surface of 326.0 feet. These values were obtained from the USGS Atlas. The **OK** button was selected to exit the boundary conditions editor.



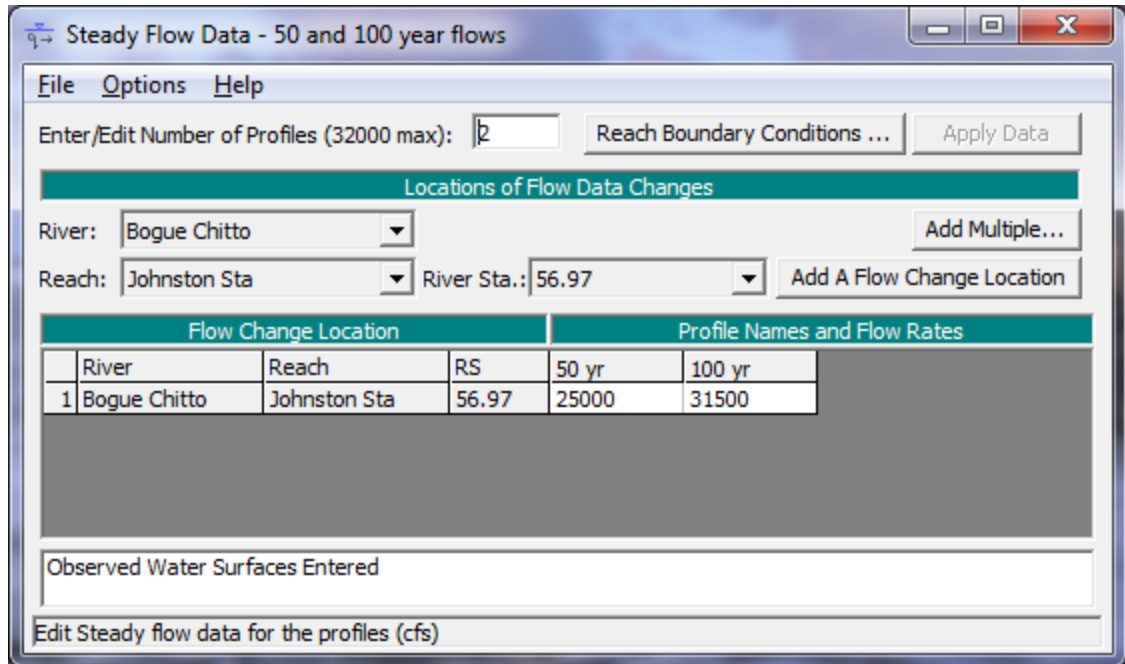

Figure 13-12: Steady Flow Data Editor

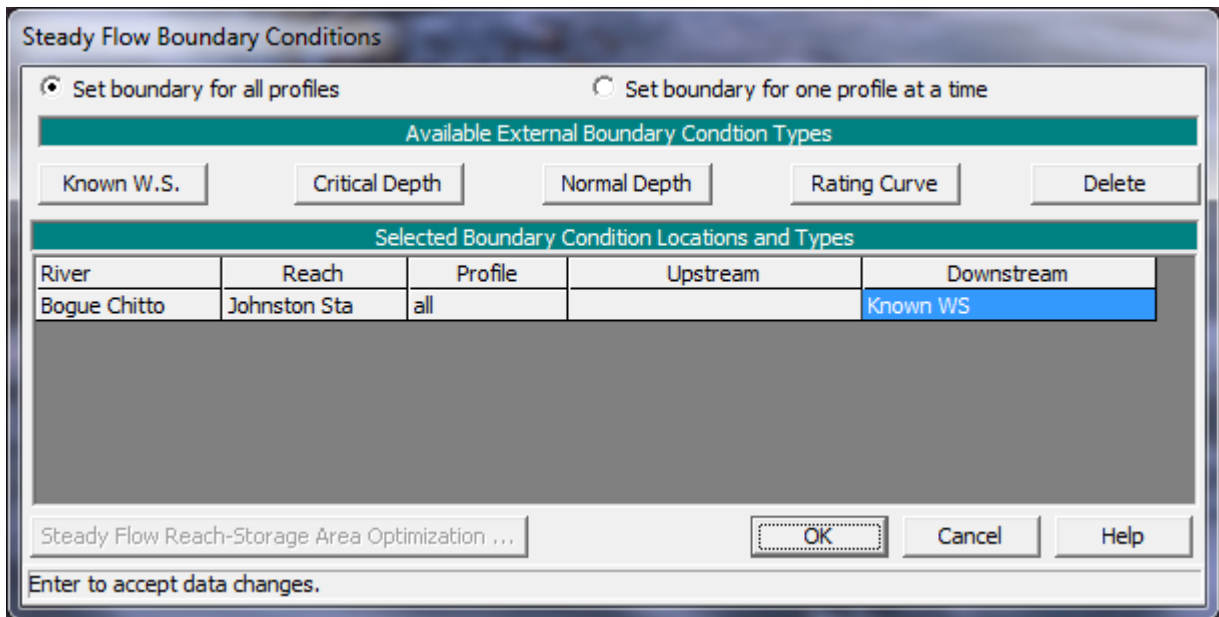

Figure 13-13: Steady Flow Boundary Conditions Data Editor

For the purposes of the analysis, if the downstream boundary conditions are not known, then the modeler should use an estimated boundary condition. However, this may introduce errors in the region of this estimated value. Therefore, the modeler needs to have an adequate number of cross sections downstream from the main area of interest so that the boundary conditions do not effect the area of interest. Multiple runs should be performed to observe the effect of changing the boundary conditions on the output of the main area of interest. For a detailed explanation of the types of boundary conditions, refer to Chapter 7 of the **User's Manual** and Chapter 3 of the **Hydraulic Reference Manual**.

A final optional component of the steady flow data was to enter the observed water surface elevation data from the USGS Atlas. This was performed by selecting **Options** and then **Observed WS ...** from the **Steady Flow Data Editor**. This activated the **Observed Water Surface Data Editor**, as shown in Figure 13.14. The *River* was selected as "Bogue Chitto" and the *Reach* was "Johnston Sta." The observed values were entered for each of the two profiles, adjacent to the river stations that observed data was available for, as shown in Figure 13.14. The **OK** button was then selected to exit the editor.

Observed WS Location					Observed Water	
	River	Reach	RS	Dn Dist	50 yr	100 yr
1	Bogue Chitto	Johnston Sta	56.97	0	348.2	348.3
2	Bogue Chitto	Johnston Sta	55.40	0	343.3	343.3
3	Bogue Chitto	Johnston Sta	53.96	0	340.4	340.6
4	Bogue Chitto	Johnston Sta	52.67	0	338.2	338.3
5	Bogue Chitto	Johnston Sta	52.46	0	337.3	
6	Bogue Chitto	Johnston Sta	52.38	0	336	337.7
7	Bogue Chitto	Johnston Sta	52.36	0	335.7	336.1
8	Bogue Chitto	Johnston Sta	52.29	0	335.2	335.6
9	Bogue Chitto	Johnston Sta	52.00	0	334.1	334.5
10	Bogue Chitto	Johnston Sta	51.15	0	330	330.5
11	Bogue Chitto	Johnston Sta	50.00	0	325.7	326

Figure 13-14: Observed Water Surface Elevations

This completed the entry for the steady flow data. The **Apply Data** button was selected on the **Steady Flow Data Editor** and the flow data was then saved as "50 and 100 year flows."

## Steady Flow Analysis

From the main program window, select **Run** and then **Steady Flow Analysis**. This will activate the **Steady Flow Analysis Window** as shown in Figure 13.15. First, the geometry file and steady flow file that were previously developed should appear in the selection boxes on the right side of the window. Then, for this simulation, a subcritical flow analysis was selected. Additionally, from the **Steady Flow Analysis** window, **Options** and then **Critical Depth Output Option** was selected. An "x" was placed beside the option for **Critical Always Calculated**. This may require additional computation time during program execution, but then the user can view the critical depth line during the review of the output for the cross sections. Select **Options** and then ensure that there is a check mark "" in front of **Check data before execution**. This will cause the program to check all of the input data to ensure that all pertinent information was entered. Next, a Short ID was entered as "wspro plan" and then the options were

saved as a plan entitled "WSPRO Bridge Analysis." Finally, **COMPUTE** was selected at the bottom of the window.

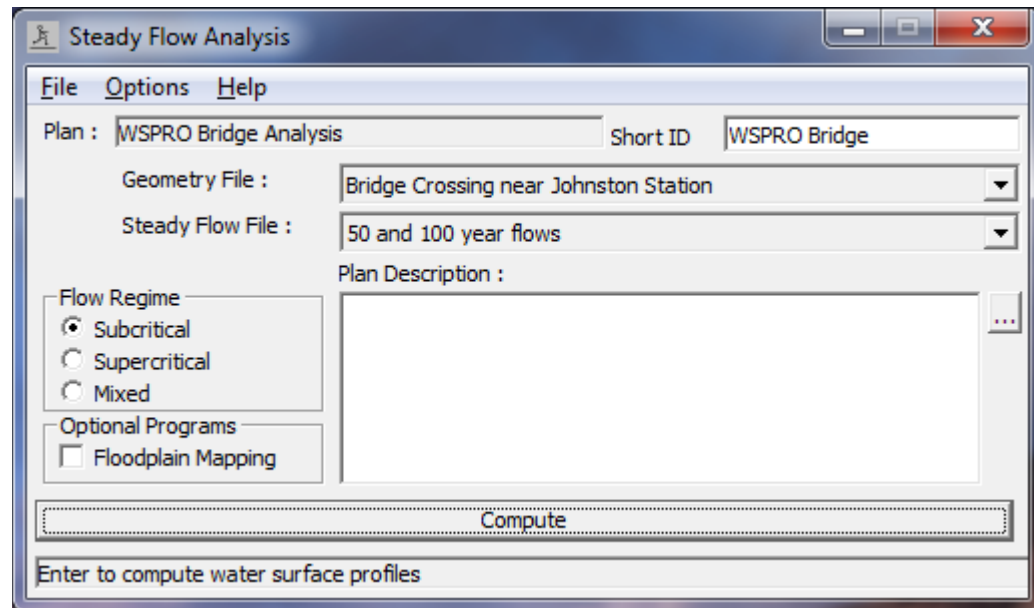

Figure 13-15: Steady Flow Analysis Window

## Review of Output

After the program has completed the analysis, the last line should read "Finished Steady Flow Simulation." Click the **Close** button at the bottom of the window to close it. This review of the output will include discussions on the water surface profiles, profile summary tables, and detailed output tables.

## Water Surface Profiles

From the main program window, select **View** and then **Water Surface Profiles**. This will activate the water surface profile plot as shown in Figure 13.16. As shown in Figure 13.16, only the second profile was selected to be displayed, for clarity. This was accomplished by selecting **Options, Profiles**, and then profile 2. Additionally, the variables of *Water Surface*, *Energy Grade Line*, *Critical Depth*, and *Observed Water Surface* were selected to be displayed, by selecting **Options** and then **Variables**. The user can select additional profiles, variables, and the zoom feature under the **Options** menu when viewing the profile plot in the program.

Figure 13.16 displays a solid line for the water surface profile and a  for the observed data, as shown in the legend. The water surface agrees well with the observed data. Additionally, it can be seen that the profile occurred in the subcritical flow regime. This ensures that for the low flow analysis, Class A low flow (subcritical flow) was occurring through the bridge. (This also occurred for the first profile.) To further review the output, the profile tables will be discussed next.

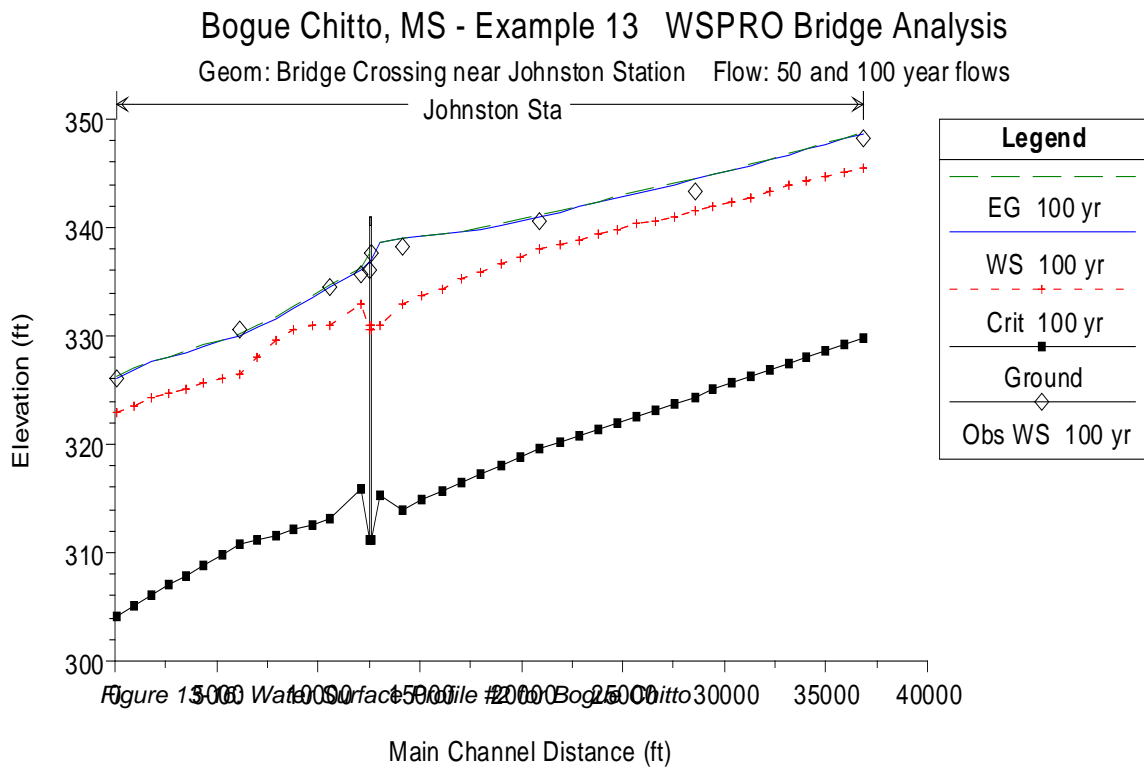

### Profile Tables

The profile tables are used to display the data for all of the river stations simultaneously. One type of profile table is the Standard Table 1 (Figure 3.17). This table can be activated by selecting from the main program window View, Profile Summary Table, and then Std. Tables, and Standard Table 1. This table displays the water surface elevation and energy grade line elevation (among other variables) for all the cross sections, and can be used to compare the calculated values to the observed water surface elevations. By selecting Options and Define Table, the additional column heading of "Obs WS" can be inserted prior to the "W.S. Elev." column. With these values displayed on the table, the user can easily compare the observed to the calculated values.

Reach	River Sta	Profile	Q Total (cfs)	Min Ch El (ft)	W.S. Elev (ft)	Crit W.S. (ft)	E.G. Elev (ft)	E.G. Slope (ft/ft)	Vel Chnl (ft/s)	Flow Area (sq ft)	Top Width (ft)	Froude # Chl
Johnston Sta	53.4071*	100 yr	31500.00	317.26	339.88	335.88	339.96	0.000459	4.25	31254.50	5409.08	0.17
Johnston Sta	53.2228*	100 yr	31500.00	316.44	339.58	335.20	339.67	0.000399	4.07	32439.07	5398.99	0.16
Johnston Sta	53.0385*	100 yr	31500.00	315.63	339.33	334.40	339.40	0.000346	3.89	33656.49	5380.29	0.15
Johnston Sta	52.8542*	100 yr	31500.00	314.81	339.11	333.73	339.18	0.000301	3.71	34856.58	5350.42	0.14
Johnston Sta	52.67	100 yr	31500.00	314.00	338.92	332.94	338.98	0.000264	3.56	36000.01	5319.82	0.13
Johnston Sta	52.46	100 yr	31500.00	315.20	338.62	330.99	338.67	0.000375	3.74	28620.84	4733.46	0.16
Johnston Sta	52.38	100 yr	31500.00	311.20	337.09	330.60	338.18	0.002289	10.12	6090.50	3369.91	0.39
Johnston Sta	52.37		Bridge									
Johnston Sta	52.36	100 yr	31500.00	311.20	336.81	330.60	337.64	0.002431	10.33	5967.06	4543.94	0.40
Johnston Sta	52.29	100 yr	31500.00	315.90	336.04	333.02	336.25	0.001143	6.11	16836.85	4543.90	0.27
Johnston Sta	52.00	100 yr	31500.00	313.10	334.45	331.06	334.64	0.001119	5.75	21415.55	4585.46	0.26
Johnston Sta	51.83*	100 yr	31500.00	312.62	333.57	331.06	333.80	0.001279	6.13	20495.01	4594.78	0.28
Johnston Sta	51.66*	100 yr	31500.00	312.14	332.59	330.51	332.84	0.001403	6.37	19872.99	4585.60	0.29
Johnston Sta	51.49*	100 yr	31500.00	311.66	331.59	329.65	331.84	0.001402	6.30	19916.29	4573.85	0.29

Total flow in cross section.

Figure 13-17: Standard Profile Table 1

Another type of profile table is the **Bridge Only** table. This table is activated from the **Std. Tables** menu and is shown in Figure 13.18, displaying the results for both profiles. The first row is for the first profile and the second row is for the second profile. The results in the table show the calculated values of the energy grade line at the cross section immediately upstream from the bridge (EG US) are 336.84 and 338.18 feet for the first and second profiles, respectively. The column heading *Min El Prs* shows a value of 340.20, which is the highest elevation of the low cord on the upstream side. If the energy grade line value had exceeded this elevation, then pressure flow would have been calculated. The *Min Top Rd* column shows the minimum elevation of the high cord on the upstream side. If the energy grade line had exceeded this value, then weir flow would have been calculated. Since the energy grade line for either profile did not exceed the low cord elevation, pressure flow, nor weir flow developed. This is also apparent since there are no values in the pressure only water surface (Prs O WS) or the weir flow (Q Weir) columns. The user is referred to "Example 2 - Beaver Creek" for an example where pressure and weir flow occurred.

Reach	River Sta	Profile	E.G. US (ft)	Min El Prs (ft)	BR Open Area (sq ft)	Prs O WS (ft)	Q Total (cfs)	Min El Weir Flow (ft)	Q Weir (cfs)	Delta EG (ft)
Johnston Sta	52.37	50 yr	336.84	340.20	6472.95		25000.00	341.01		0.40
Johnston Sta	52.37	100 yr	338.18	340.20	6472.95		31500.00	341.01		0.53

Upstream energy grade elevation at bridge or culvert (specific to that opening, not necessarily the weighted average).

Figure 13-18: Bridge Only Profile Table

To determine the method that was used for the final energy grade line value at the bridge, the **Bridge Comparison** table was activated from the **Std.**

**Tables** menu, and is shown in Figure 13.19. The two rows display the results for each of the two flow profiles, in ascending order. The river station in the second column is set at 52.37 (the only bridge location for this reach). The sixth through ninth columns show the results of the low flow methods that were chosen to be computed : Energy, Momentum, Yarnell and WSPRO methods, respectively. The values of the energy grade line that the program used is shown in the third column. As shown in Column five, the program used the result from the WSPRO method, as had been selected in the **Bridge Modeling Approach Editor**. Finally, the fourth column shows the water surface elevation that coincides with the energy elevation used by the program. (Note: There were no results in the last two columns for the high flow methods since only low flow occurred through the bridge opening.)

The results of the WSPRO method were only slightly greater than the results of the energy method. Both the momentum and Yarnell methods returned valid results since the water surface did not encounter the low cord of the deck. The user can adjust the input parameters of the WSPRO method to determine the significance of the values on the output, such as slope of the abutments and the inclusion of wing walls or guide banks.

The screenshot shows a software window titled "Profile Output Table - Bridge Comparison". The window has a menu bar with "File", "Options", "Std. Tables", "User Tables", "Locations", and "Help". Below the menu bar is a status bar that reads "HEC-RAS Plan: WSPRO Bridge River: Bogue Chitto Reach: Johnston Sta" and a "Reload Data" button. The main area contains a table with the following data:

Reach	River Sta	Profile	E.G. US. (ft)	W.S. US. (ft)	Br Sel Method	Energy EG (ft)	Momen. EG (ft)	Yarnell EG (ft)	WSPRO EG (ft)	Prs O EG (ft)	Prs/Wr EG (ft)
Johnston Sta	52.37	50 yr	336.84	336.02	WSPRO	336.84	336.78	336.44	336.84		
Johnston Sta	52.37	100 yr	338.18	337.09	WSPRO	338.14	338.03	337.60	338.18		

Below the table is a text box with the label "Upstream energy grade elevation at bridge or culvert (specific to that opening, not necessarily the weighted average)."

Figure 13-19: Bridge Comparison Table

The final profile table that will be discussed is the **Six XS Bridge** table, which is also selected from the **Std. Tables** menu. This table is shown in Figure 13.20, for profile 2. This table is specifically designed to show the data for the six cross sections that are used in the hydraulic computations through the bridge. The water surface and energy grade line values are shown in the first two columns of data, and are used to determine the water surface profile through the bridge. The *C&E Loss* column of the table shows the contraction or expansion losses. As shown in the figure, the only river station (within the six bridge cross sections) that had an expansion or contraction loss was river station 52.36 (to river station 52.29). This is because the WSPRO method, by default, only includes an expansion loss between the exit section and the cross section immediately downstream from the bridge. The user can include additional contraction/expansion losses by selecting the losses on the **WSPRO Data Editor**. For this example, no additional energy losses were selected, so no additional contraction or expansion losses appeared on the table.

Reach	River Sta	Profile	E.G. Elev (ft)	W.S. Elev (ft)	Crit W.S. (ft)	Frctn Loss (ft)	C & E Loss (ft)	Top Width (ft)	Q Left (cfs)	Q Channel (cfs)	Q Right (cfs)	Vel Chnl (ft/s)
Johnston Sta	52.46	100 yr	338.67	338.62	330.99	0.49	0.00	4733.46	15698.04	5732.87	10069.10	3.74
Johnston Sta	52.38	100 yr	338.18	337.09	330.60	0.12	0.00	3369.91	4972.52	20639.09	5888.40	10.12
Johnston Sta	52.37 BR U	100 yr	338.06	336.86	331.00	0.28	0.00	396.06	4172.62	20462.71	6864.67	10.57
Johnston Sta	52.37 BR D	100 yr	337.77	336.60	331.00	0.13	0.00	395.50	4132.30	20583.22	6784.48	10.77
Johnston Sta	52.36	100 yr	337.64	336.81	330.60	0.76	0.63	4543.94	4933.63	20778.11	5788.26	10.33
Johnston Sta	52.29	100 yr	336.25	336.04	333.02	1.60	0.01	4543.90	15023.04	10443.31	6033.66	6.11

Energy gradeline for given WSEL.

Figure 13-20: Six XS Bridge Table for Profile 2

### Detailed Output Tables

In addition to the profile tables, the user can view detailed output tables, which provide information at each specific cross-sections. A type of detailed output table that displays results for the bridge is shown in Figure 13.21. This table was activated from the main program window by selecting **View, Detailed Output Table**, then **Type** and **Bridge**. The *River* and *Reach* were selected as "Bogue Chitto" and "Johnston Sta.", and the river station was 52.37 (the only river station that had a bridge). The *Profile* was selected as "2" and the *Opening* was "Bridge #1" (the only opening at this cross section). The table shows data for the cross sections inside the bridge, as well as the cross section just upstream from the bridge. As the user selects the different table fields, the description for the variables will appear at the bottom of the table. At the bottom of the left side of the table, the field *Br Sel Mthd* shows that the "WSPRO" results were used for the bride analysis. Additionally, the *Coef of Q* field shows that the WSPRO coefficient of Q value was calculated as 0.72 for the second profile.

Plan: WSPRO Bridge Bogue Chitto Johnston Sta RS: 52.37 Profile: 100 yr

Element	Inside BR US	Inside BR DS
E.G. US. (ft)	338.18	
W.S. US. (ft)	337.09	
Q Total (cfs)	31500.00	
Q Bridge (cfs)	31500.00	
Q Weir (cfs)		
Weir Sta Lft (ft)		
Weir Sta Rgt (ft)		
Weir Submerg		
Weir Max Depth (ft)		
Min El Weir Flow (ft)	341.01	
Min El Prs (ft)	340.20	
Delta EG (ft)	0.53	
Delta WS (ft)	0.29	
BR Open Area (sq ft)	6472.95	
BR Open Vel (ft/s)	6.26	
Coef of Q	0.72	
Br Sel Method	WSPRO	
E.G. Elev (ft)	338.06	337.77
W.S. Elev (ft)	336.86	336.60
Crit W.S. (ft)	331.00	331.00
Max Chl Dpth (ft)	25.66	25.40
Vel Total (ft/s)	6.13	6.26
Flow Area (sq ft)	5139.72	5034.58
Froude # Chl	0.41	0.42
Specif Force (cu ft)	46397.90	45650.17
Hydr Depth (ft)	12.98	12.73
W.P. Total (ft)	855.88	846.08
Conv. Total (cfs)	332437.9	325074.3
Top Width (ft)	396.06	395.50
Frctn Loss (ft)	0.28	0.13
C & E Loss (ft)	0.00	0.00
Shear Total (lb/sq ft)	3.37	3.49
Power Total (lb/ft s)	20.63	21.82

**Errors, Warnings and Notes**

- Note: Multiple critical depths were found at this location. The critical depth with the lowest, valid, water surface was used.
- Warning: The conveyance ratio (upstream conveyance divided by downstream conveyance) is less than 0.7 or greater than 1.4. This may indicate the need for additional cross sections.
- Note: Multiple critical depths were found at this location. The critical depth with the lowest, valid, water surface was used.

Select Profile

Figure 13-21: Bridge Type Detailed Output Table

At this time, the user can select to view the data for the first profile as well as viewing the cross section tables for the cross sections. This completed the review of the output for the cross section tables. Next, the locations of the cross sections in relation to the bridge were evaluated, by using the information presented in the various tables that were previously discussed.

## Evaluation of Cross Section Locations

As stated previously, the locations of the cross sections and the values selected for the expansion and contraction coefficients in the vicinity of the bridge are crucial for accurate prediction of the energy losses through the bridge structure. For this example, the locations of the cross sections and the energy loss coefficients were evaluated for the second profile. The following analysis is based on data that were developed for low flow events occurring through bridges and the modeler should use caution when applying the procedure for other than low flow situations. Each of the reach length and coefficient evaluation procedures are discussed in the following sections.



## Expansion Reach Length

The expansion reach length,  $L_e$ , is defined as the distance from the cross section placed immediately downstream of the bridge to the cross section where the flow is assumed to have fully expanded. For this example, this distance is from cross section 52.36 to cross-section 52.00. Initially, the expansion reach length was estimated using the table values presented in Appendix B of the **Hydraulic Reference Manual**. After the analysis, the modeler can evaluate the initial estimate of the expansion reach length. For the analysis, it is recommended to use the regression results from the Army Corps of Engineers study [HEC-1995], which are summarized in the same Appendix B. The results of the study suggest the use of Equation 13-1 to evaluate the expansion reach length. This equation is valid when the modeling situation is similar to the data used in the regression analysis. (In the document, alternative expressions are presented for other situations.) The equation is:

$$L_e = ER(\bar{L}_{obs}) = -298 + 257 \left( \frac{F_{52.36}}{F_{52.00}} \right) + 0.918\bar{L}_{obs} + 0.00479Q \quad (13-1)$$

- where:  $L_e$  = expansion reach length, ft
- $ER$  = expansion ratio
- $F_{52.36}$  = main channel Froude number at the cross section immediately downstream of the bridge (cross section 52.36 for this example)
- $F_{52.00}$  = main channel Froude number at the cross section of fully expanded flow (initially cross section 52.00 for this example)
- $L_{obs}$  = average length of obstruction caused by the two bridge approaches, ft
- $Q$  = total discharge, ft<sup>3</sup>/s

(Note: The subscripts used in Equation 13-1 and all subsequent equations reflect the river station numbering for this example.)

From the field data, the average length of the obstruction is approximately 1770 feet and the total discharge,  $Q$ , is 31500 cfs for the high flow event. From the initial analysis, the value of the Froude number at cross-section 52.36 was 0.40 and at cross section 52.00 was 0.27 (as shown on **Standard Table 1**). Substituting the values into Equation 13-1 yielded that the expansion reach length,  $L_e$ , was approximately 1874 feet. This equation has a standard error of 96 feet, which yields an expansion reach length range from 1778 to 1970 feet to define the 68% confidence band. The distance used for the expansion reach length (the distance from cross section 52.36 to cross section 52.00) was set to be 1956 feet in the main channel, which is approximately equal to the calculated distance of 1874 feet. Therefore, the expansion reach length was determined to be set appropriately.

If the reach lengths were not acceptable, then the modeler has the option to adjust the length so that it is within the calculated range. Then, after a new

analysis, the new Froude numbers should be used to calculate a new expansion reach length. If the geometry is not changing rapidly in this region, then only 1 or 2 iterations should be necessary to obtain a constant expansion reach length value.

### Contraction Reach Length

The contraction reach length,  $L_c$ , is defined as the distance from the cross section located immediately upstream of the bridge (52.38) to the cross section that is located where the flow lines are parallel and the cross section exhibits fully effective flow (52.46). To evaluate this reach length, the regression results (shown as Equation 13-2 below) from the Army Corps of Engineers study [HEC-1995] was used. The equation is:

$$L_c = CR(\bar{L}_{obs}) = 263 + 38.8 \left( \frac{F_{52.36}}{F_{52.00}} \right) + 257 \left( \frac{Q_{ob}}{Q} \right)^2 - 58.7 \left( \frac{n_{ob}}{n_c} \right)^{0.5} + 0.161 \bar{L}_{obs} \quad (13-2)$$

where:  $L_c$  = contraction reach length, ft

$CR$  = contraction ratio

$F_{52.36}$  = main channel Froude number at the cross section immediately downstream of the bridge (cross section 52.36 for this example)

$F_{52.00}$  = main channel Froude number at the cross section of fully expanded flow (cross section 52.00 for this example)

$Q_{ob}$  = discharge conveyed in the two overbanks at cross section 52.46, cfs

$Q$  = total discharge, ft<sup>3</sup>/s

$n_{ob}$  = Manning n value for the overbanks at section 52.46

$n_c$  = Manning n value for the main channel at section 52.46

From the field data and the results of the initial analysis, the Froude numbers at sections 52.36 and 52.00 were 0.40 and 0.27, respectively, the total over bank flow at cross section 52.46 was approximately 25773 cfs (15697 + 10076), the total flow was 31500 cfs, the weighted n value for both of the overbanks was 0.13, the n value for the main channel was 0.05 (from the **Cross Section** Type table), and the average length of the obstruction was 1770 feet. Substitution of these values into Equation 13-2 yielded the contracted reach length of 685 feet. This equation has a standard error of 31 feet which results in a contraction reach length range from 716 to 654 feet to define the 68% confidence band. For this example, the distance from cross section 52.38 to cross section 52.46 was set at 380 feet along the main channel. An additional analysis was performed with the contraction reach length set at 685 feet and no appreciable difference was observed in the results. Therefore, the contraction reach length of 380 feet considered as appropriate for this example.

## Expansion and Contraction Coefficients

For the WSPRO method, only an expansion loss is used from the river station immediately downstream of the bridge (52.36) to the river station of expanded flow (52.29). This expansion loss, as was shown in Figure 13.20, is determined from Equation 5-7 and is discussed in Chapter 5 of the **Hydraulics Reference Manual**. Additionally, the HEC-RAS WSPRO routine allows the modeler the option of adding additional expansion and contraction energy losses. These losses would be computed using the absolute value of the difference of the velocity heads times the appropriate coefficient. For this example, no additional energy losses were added. The user is referred to Chapter 3 of the **Hydraulics Reference Manual** for a further discussion on expansion and contraction coefficients.

In summary, the above recommendations for the expansion and contraction reach lengths represent an improvement in the general methodology behind the prediction of these values. The modeler is recommended to apply these new criteria as a more substantial method for determining the required values. As a final note, after the initial analysis, the expansion and the contraction reach lengths as well as the expansion and contraction coefficients should be evaluated simultaneously. Then, adjustments should be made to the reach length and coefficient values before a subsequent analysis is performed. Finally, the new data should be used to reevaluate all of the reach lengths and coefficients. This procedure will ensure that the modeler is always using the current flow data for the analysis.

## Summary

This example demonstrated the use of the WSPRO routines in HEC-RAS to calculate water surface profiles along a river reach that contained a bridge crossing. The WSPRO routines are used for low flow analysis, and have been adapted to the HEC-RAS methodology of cross section locations around and through a bridge. The user has the options to include additional energy losses, as well as account for the type of abutments and the presence of wing walls and guide banks in the WSPRO routines. By adjusting these input parameters, the modeler can determine the impact on the calculated coefficient of discharge value and the resulting water surface profiles.



## CHAPTER 14

# Ice-Covered River

### Purpose

This example, which demonstrates the analysis of an ice-covered river, focuses on describing a river ice cover and a river ice jam in HEC-RAS. The water surface elevations resulting from the presence of an ice cover or an ice jam can then be compared to the equivalent open water case. The estimated ice jam thicknesses can also be compared to the measured jam thickness<sup>1</sup>.

An ice cover changes the effective channel geometry. This means that separate geometry files must be created for the open water case, the ice cover case, and the ice jam case. The best approach is to create a separate plan for each. See Chapter 5 of the **User's Manual** and Example 7 of the **Application Manual** for a further discussion on working with projects and a discussion of the files that constitute a plan.

The data for this example were entered in metric units. To review the data files for this example, from the main HEC-RAS window, select **File** and then **Open Project**. Go to the directory in which you have installed the HEC-RAS example data sets. From the "Applications Guide\Chapter 14 – Ice Covered River" subdirectory, select the project labeled "Thames River Ice Jam - Example 14." This will open the project and activate the following files:

Plan:	"Thames River Open Water Analysis"
Geometry:	"Thames River Open Water Data"
Flow:	"Estimated Thames River Flow"

### Open Water Analysis

Three geometry files are created for this project, and all are based on the same channel geometry and channel properties. Only the ice cover description varies among plans.

---

<sup>1</sup> Beltaos, S., and W.J. Moody (1986) Measurements of the Configuration of a Breakup Jam. NWRI Contribution 86-123. National Water Research Institute, Canada Center for Inland Waters, Burlington, Ontario, Canada L7R 4A6

## Open Water Geometry

A geometry file was created that modeled the existing conditions for a reach of the Thames River. This reach is a natural channel where an ice jam occurred. To view the river system schematic, select **Edit** and then **Geometric Data** from the main program window. This will activate the **Geometric Data Editor** and display the river system schematic. This is a very simple schematic with a single straight channel. The river is the Thames River and it has only a single reach: Ice Jam Section.

The river reach is defined by 22 river stations. The user can view the geometric data for each river station by selecting the **Cross Section** icon from the **Geometric Data Editor**. The data for each river station comprises X and Y coordinates, downstream reach lengths, Manning's n values, main channel bank stations, and contraction and expansion coefficients. There was no out-of-channel flow during the ice jam event. As a result, overbank areas are not included. There are no structures in this section of channel.

After all geometric data were entered, the geometry file was saved using the title "Thames River Open Water Data."

## Steady Flow Data

Next, the steady flow data file was created by selecting **Edit** and **Steady Flow Data** from the main program window. This activated the **Steady Flow Data Editor**. The profile selected to be analyzed corresponds to the estimated flow during the ice jam event. The flow value of 261 cubic meters per second (CMS) was entered at river station 42000 (the upstream river station), and a known downstream water surface elevation of 177.64 meters was entered by selecting the **Boundary Conditions** icon. Next, the observed water surface elevations during the ice jam event were entered by selecting **Options** and then **Observed WS** using the **Steady Flow Data Editor**. The observed water levels at nine river stations were then entered. After all steady flow data were entered, the steady flow file was saved using the title "Estimated Thames River Flow."

## Open Water Plan

After the geometric data and steady flow data were entered and saved, a plan entitled "Thames River Open Water Analysis" was created by first selecting **Run** and then **Steady Flow Analysis** from the main program window. The plan itself was created in the **Steady Flow Analysis Window**. Again, see Chapter 5 of the **User's Manual** and Example 7 of the **Application Manual** for further discussion of the files that constitute a plan. A subcritical analysis was chosen as the **Flow Regime** and then **File** and **Save Plan As** were selected. The title "Thames River Open Water Analysis" was entered and the **OK** button selected. The **Short ID** for this plan was set as "open\_water."

After the plan was saved, the **Compute** button was selected to execute the program. Note that the calculation required only one iteration to solve the steady flow equations for the entire channel.

## Open Water Output

The rather straightforward open water output will not be reviewed here. Note that the water surface elevations calculated assuming open water do not match the observed ice jam elevations at all, as would be expected.

## Ice Cover Analysis

To analyze the case of a continuous ice cover, an ice cover with a constant thickness and roughness will be placed on the channel. To do this analysis, the geometry file was modified to reflect the presence of the ice cover. Then a new plan was created with the new geometry file and the original steady flow file. This procedure is outlined below.

### Ice Cover Geometry

To add the ice cover, the geometry file "Thames River Open Water Data" was activated. At this point, the modeler has the option of entering the ice cover properties cross section by cross section, by selecting the **Cross Section** icon from the **Geometric Data Editor**, or by selecting **Tables** and then **Ice Cover** from the **Geometric Data Editor**. In this case, the **Tables** option was used. First, the **Chan Ice Thickness** column was highlighted by dragging the mouse over the entire length of the column. Then the **Set Values** icon was clicked and the value of 0.5 meters was entered. This value corresponds to a reasonable, end-of-winter ice thickness that results from thermal growth. It was not necessary to enter ice thicknesses for either overbank, as no overbank areas were included in this simulation. In a similar way, the Manning's n value was set for the channel ice cover by entering the Manning n value in the **Chan ice Mann n** column using the **Set Values** icon. In this case a value of 0.03 was used, typical for a floating smooth ice cover.

After all of the ice cover data were entered, the geometry file was saved using the Geometric Data editor by selecting **File** and the **Save Geometry Data As**. The title entered was "Thames River Ice Cover Data."

### Steady Flow Data

The steady flow analysis of the ice-covered channel will use the same flow data used in the open water geometry. Therefore, there were no adjustments made to the steady flow data in the file "Estimated Thames River Flow."

### Ice Cover Plan

A new plan was created from the geometry file with the ice cover and the steady flow data file. This plan was created by first selecting **Run** and then **Steady Flow Analysis** from the main program window. The plan itself was created in the **Steady Flow Analysis Window**. A **Short ID** for this plan was set as "ice\_covered." The geometry file "Thames River Ice Cover Data" and the steady flow file "Estimated Thames River Flow" were selected by using the down arrows on the right side of the window. A subcritical analysis was chosen as the **Flow Regime**, and then **File** and **Save Plan As** were selected.

The title "Thames River Ice Cover Analysis" was entered and the **OK** button selected. After the plan was saved, the **Compute** button was selected to execute the program. Note that the calculation required only one iteration to solve the steady flow equations for the entire channel.

### Ice Cover Output

The rather straightforward ice-covered channel output will not be reviewed here. It can be noted that the water surface elevations calculated by assuming an ice cover do not match the observed ice jam elevations at all, as would be expected.

## Ice Jam Analysis

To analyze the case of an ice jam, an ice jam simulation will be selected for the channel. To do this analysis, the geometry file was modified to reflect the presence of the ice jam. Then a new plan was created with the new geometry file and the original steady flow file. This procedure is outlined below.

### Ice Jam Geometry

To add the ice jam, the geometry file "Thames River Open Water Data" was activated. At this point, the modeler has the option of entering the ice jam properties cross section by cross section, by selecting the **Cross Section** icon from the **Geometric Data Editor**, or by selecting **Tables** and then **Ice Cover** from the **Geometric Data Editor**. In this case, the **Tables** option was used. First, the **Chan Ice Thickness** column was highlighted by dragging the mouse over the entire length of the column. Then the **Set Values** icon was clicked and the thickness value of 0.5 meter was entered. In fact, HEC-RAS will estimate the jam thickness, but these entered values will represent the minimum allowable ice thickness in the jam. This thickness was selected on the basis of field observations, which showed that no cross section had a minimum thickness less than 0.5 m. This minimum jam thickness value will vary from river reach to river reach, and it is probably worth trying several minimum jam thickness values at any location. Next, it was necessary to indicate to HEC-RAS that this simulation should be treated as an ice jam and not an ice cover with fixed thickness. This is done in the **Ice Jam Chan** column of the **Ice Cover Table** by changing the default value of **n** (no) to **y** (yes) for each river station where the ice jam is thought to have occurred. (Note that this must be done for each river section individually, as the **Set Values** icon will not work for yes/no input.) In this case, it is not necessary to change the default values of **n** in the column **Ice Jam OB**, as there is no overbank flow.

It is necessary to fix the ice thickness in the sections immediately upstream and downstream of the jam, because a cross section with known ice thickness is required at the upstream and downstream limits of the jam. In this case, a thickness of 0.5 m was set for the upstream and downstream river station of the Ice Jam Reach, and the value in the **Ice Jam Chan** column was set to **n** for these two river stations. It is important to remember that for every ice jam, there must be an **n** set in the **Ice Jam Chan** column immediately upstream and downstream of the jam.



The nominal Manning's  $n$  value was set for the channel ice cover by entering the Manning  $n$  value in the **Chan ice Mann n** column using the **Set Values** icon. However, in this case, it is desired that HEC-RAS estimate the Manning's  $n$  of the jam using the procedure outlined in the **Hydraulic Reference Manual**. It is necessary to indicate to HEC-RAS that this simulation should estimate the Manning's  $n$  of the ice jam and not use the value entered in the **Chan ice Mann n** column. This is done in the **Fixed Mann n** column by changing the default value of **y** to **n**. The default value of **y** was entered for the upstream and downstream river stations of the Ice Jam Reach, because these stations are considered to have a known roughness as well as a known thickness.

The other parameters, which describe the ice jam material properties, such as the friction angle, porosity, and stress ratio, were all left at their default values. In most cases, it will not be necessary to modify these values from their default values.

After all of the ice cover data were entered, the geometry file was saved using the Geometric Data editor by selecting **File** and the **Save Geometry Data As**. The title entered was "Thames River Ice Jam Data."

### Steady Flow Data

The steady flow analysis of the ice jam will use the same flow data as the open water geometry. Therefore there were no adjustments made to the steady flow data in the file "Estimated Thames River Flow."

### Ice Jam Plan

A new plan was created from the geometry file with the ice cover and the steady flow data file. This plan was created by first selecting **Simulate** and then **Steady Flow Analysis** from the main program window. The plan itself was created in the **Steady Flow Analysis Window**. A **Short ID** for this plan was set as "ice\_jam." The geometry file "Thames River Ice Jam Data" and the steady flow file "Estimated Thames River Flow" were selected by using the down arrows on the right side of the window. A subcritical analysis was chosen as the **Flow Regime** and then **File** and **Save Plan As** were selected. The title "Thames River Ice Jam Analysis" was entered and the **OK** button selected. After the plan was saved, the **Compute** button was selected to execute the program. Note that the calculation required a number of iterations to solve the steady flow equations and the ice jam force balance equation for the entire reach. The calculations iterate until the calculated jam thicknesses and water surface elevations converge to a constant value within the minimum tolerances. See the **Hydraulic Reference Manual** section on ice jam calculations for more information on the convergence criteria.

### Ice Jam Output

The ice jam results are shown in a graphical profile plot in Figure 14.1. The calculated ice jam thickness along the channel, the water surface elevations, and the observed water surface elevations at selected cross sections are

shown. Note that the calculated ice jam water surface elevations match the observed water surface elevations reasonably well.

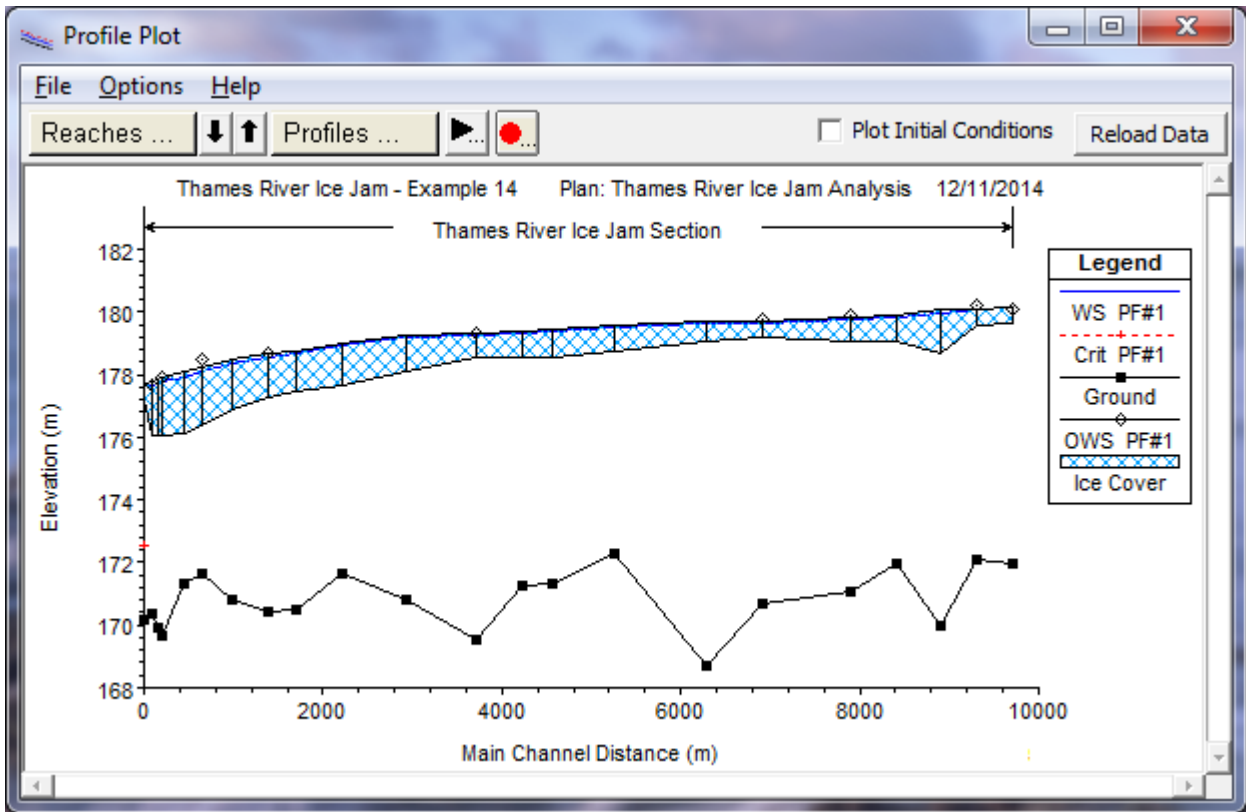

Figure 14-1: Ice Jam Profile Plot

## Comparison of Open Water, Ice Cover, and Ice Jam Results

To compare the output from the three plans, the user can view the results graphically and in tabular format. In the interest of brevity, not all the graphical plots that are available will be illustrated here.

### Profile Plot

At this point, the results of all three plans can be compared. The profile plot of the ice jam, the river ice cover, and the open water results can be seen in Figure 14.2 It is also possible to graphically display comparisons of the results in Cross Section Plots, and X-Y-Z- Perspective Plots.

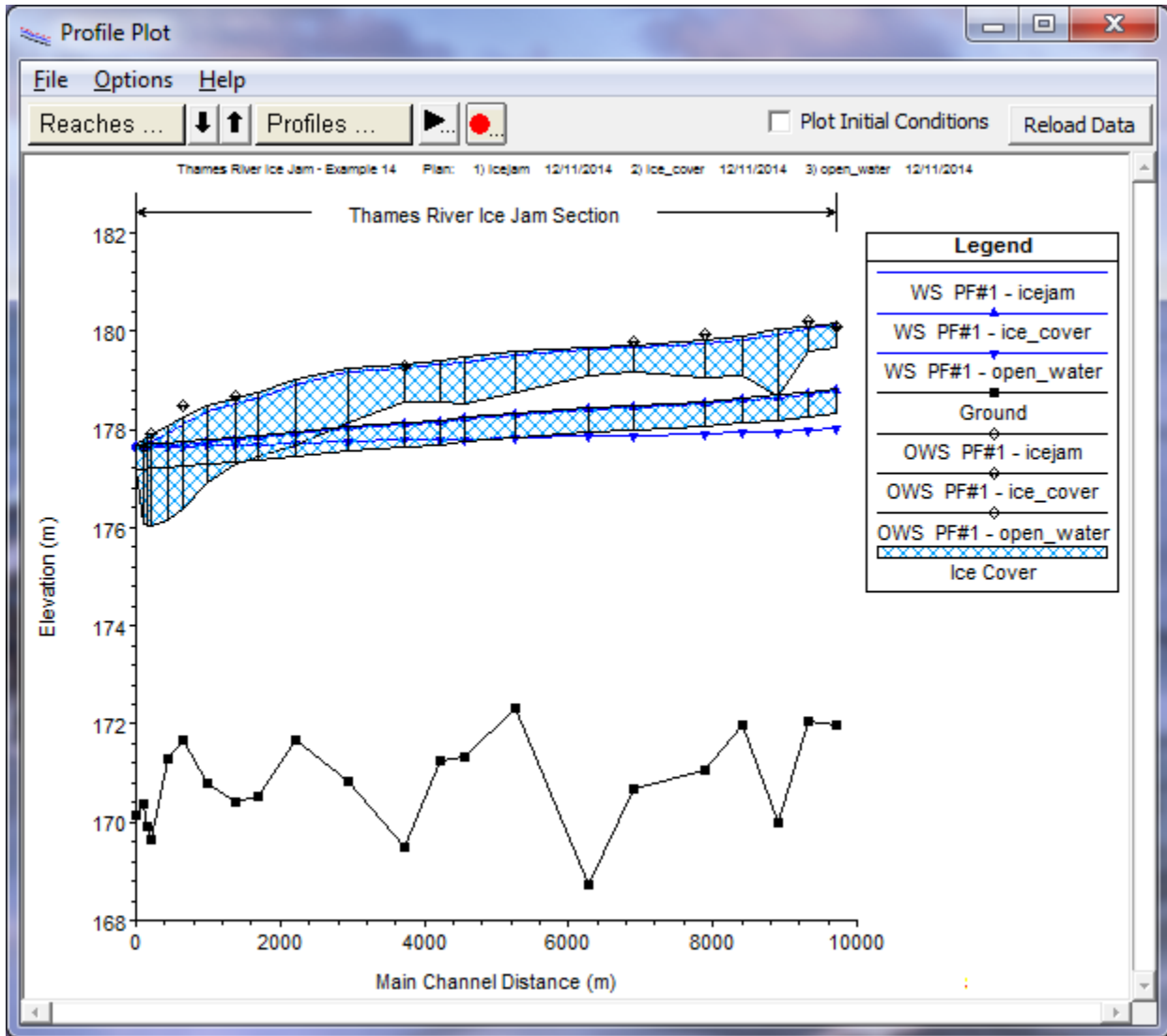

Figure 14-2: Profile Plot displaying the ice jam, ice cover, and open water results

### Ice Table

In addition to graphical displays, it is possible to compare the output in tabular form. From the main program window, select **View** and then **Profile Summary Table**. By selecting **Ice Cover** under the **Std. Tables** menu, a table with the ice results will be shown. This table includes the ice thickness (if any) at each river section, the calculated water surface elevations at each section, the cumulative ice volume in the channel and overbanks, and the calculated weighted Manning's n at each section. This table can be used to compare the results from each plan. An example ice table is shown in Figure 14.3.

Example 14 Ice-Covered River

Profile Output Table - Ice Cover

File Options Std. Tables User Tables Locations Help

HEC-RAS Plan: icejam River: Thames River Reach: Ice Jam Section Profile: PF#1 Reload Data

Reach	River Sta	Profile	W.S. Elev (m)	Ice Thick LOB (m)	Ice Thick Chan (m)	Ice Thick ROB (m)	Ice Vol Total (m3)	Ice Vol. LOB (m3)	Ice Vol. Chan (m3)
Ice Jam Section	42000	PF#1	180.12	0.00	0.50	0.00	495952.30		495952.30
Ice Jam Section	41590	PF#1	180.05	0.00	0.50	0.00	485676.50		485676.50
Ice Jam Section	41190	PF#1	179.94	0.00	1.37	0.00	468004.30		468004.30
Ice Jam Section	40690	PF#1	179.82	0.00	0.79	0.00	441622.20		441622.20
Ice Jam Section	40180	PF#1	179.76	0.00	0.75	0.00	418370.70		418370.70
Ice Jam Section	39190	PF#1	179.66	0.00	0.55	0.00	379539.50		379539.50
Ice Jam Section	38560	PF#1	179.63	0.00	0.60	0.00	362014.30		362014.30
Ice Jam Section	37530	PF#1	179.53	0.00	0.87	0.00	326636.20		326636.20
Ice Jam Section	36670	PF#1	179.38	0.00	0.93	0.00	296980.80		296980.80
Ice Jam Section	36320	PF#1	179.31	0.00	0.82	0.00	281515.00		281515.00
Ice Jam Section	35820	PF#1	179.26	0.00	0.76	0.00	259904.40		259904.40
Ice Jam Section	35030	PF#1	179.16	0.00	1.13	0.00	216657.10		216657.10
Ice Jam Section	34320	PF#1	178.90	0.00	1.36	0.00	170795.80		170795.80
Ice Jam Section	33790	PF#1	178.65	0.00	1.31	0.00	138786.00		138786.00
Ice Jam Section	33490	PF#1	178.54	0.00	1.35	0.00	119784.90		119784.90
Ice Jam Section	33090	PF#1	178.36	0.00	1.59	0.00	90792.45		90792.45
Ice Jam Section	32740	PF#1	178.10	0.00	1.88	0.00	61759.61		61759.61
Ice Jam Section	32550	PF#1	177.91	0.00	1.95	0.00	42203.21		42203.21
Ice Jam Section	32310	PF#1	177.76	0.00	1.88	0.00	15279.47		15279.47
Ice Jam Section	32260	PF#1	177.71	0.00	1.84	0.00	10487.74		10487.74
Ice Jam Section	32200	PF#1	177.66	0.00	1.74	0.00	5502.07		5502.07
Ice Jam Section	32100	PF#1	177.64	0.00	0.50	0.00			

Calculated water surface from energy equation.

Figure 14-3: Tabular Ice Output Table

## CHAPTER 15

# Split Flow Junction with Lateral Weir/Spillway

### Purpose

This example demonstrates the use of HEC-RAS to optimize two different split flow problems: a lateral weir with gated spillway and a looped network. In both situations, the program uses an iterative procedure to compute the flows and energies at a given point (either the lateral weir or the upstream junction of the looped network).

To perform the analysis, the user must enter the geometric data for the lateral weir and gates, along with the geometry of the river reach system. Then, the user must enter the opening height of each gate group for each flow profile in the **Steady Flow Editor**. Finally, the user should set the split flow optimization flag (to perform the iterative procedure) for the lateral weir and for the junction at the upstream end of the looped network. The modeler is referred to Chapter 6 of the **User's Manual** for discussion on entering the geometric data for the weir and gated spillways and junctions and multiple reaches, Chapter 7 of the **User's Manual** for entering the gate opening flow data, and Chapter 8 of the **Hydraulic Reference Manual** for the hydraulic analysis procedures for analyzing the flow through the gate openings and over the weir.

To review the data files for this example, from the main HEC-RAS window, select **File** and then **Open Project**. Go to the directory in which you have installed the HEC-RAS example data sets. From the "Applications Guide\Chapter 15 – Split Flow Junction with Lateral Weir" subdirectory, select the project labeled "Split Flow Junction with Lateral Weir - Example 15." This will open the project and activate the following files:

Plan:	"Split Flow"
Geometry:	"Lateral Weir with Full Looped Network"
Flow:	"3 Flow Profiles"

### Geometric Data

To view the geometric data for the river system, from the main program window select **Edit** and then **Geometric Data**. This will activate the **Geometric Data Editor** and display the river system schematic as shown in Figure 15.1. The schematic displays the 24 river stations of the rivers "Spruce Creek" and "Bryon Creek," with river station 1278 as the upstream cross section and 0 as the downstream cross section.

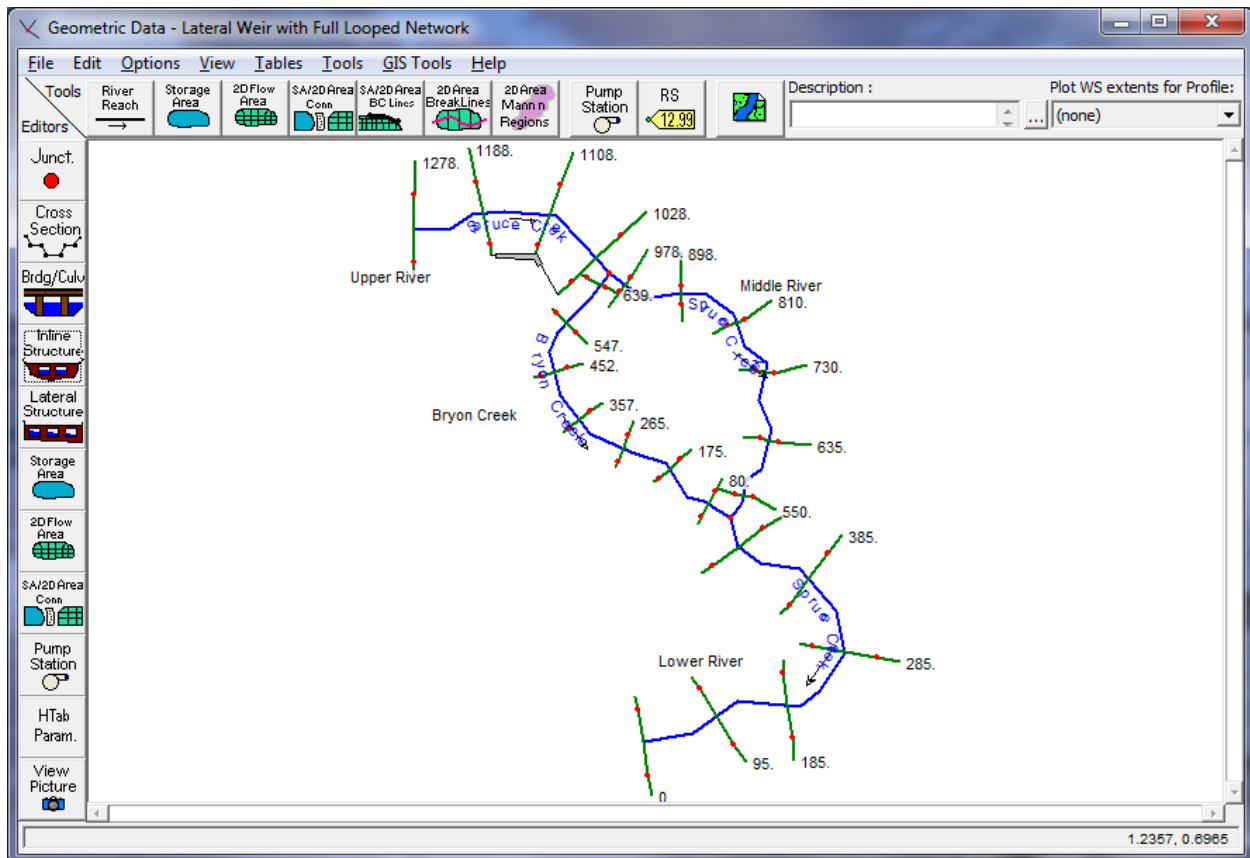

Figure 15-1: River System Schematic for Split Flow Example

### Stream Junction Data

There are four different river reaches in the river system schematic. Spruce Creek is divided into three different reaches: Upper River, Middle River, and Lower River. Bryon Creek is the fourth reach. Bryon Creek and Middle River, together form a closed loop between the Meadows river junction and the Pottsville river junction. The junction editor for the Meadows river junction is shown in Figure 15.2 Meadows is the upstream junction. This is where the flow splits into the two different rivers. This will be discussed in more detail later.

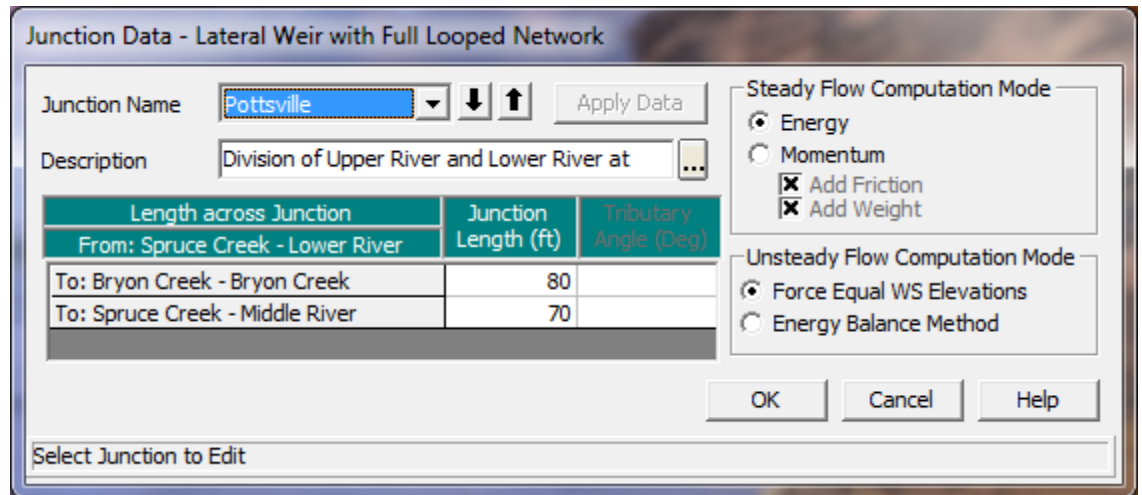

Figure 15-2: Meadows Junction

### Cross Section Data

The cross section data consists of the X-Y coordinates, Manning's n values, contraction and expansion coefficients, etc. The user can view this data for each river station by selecting the **Cross Section** icon on the left side of the **Geometric Data Editor**. For this example, a lateral weir was added at river station 1150 and will be discussed in the next section. Figure 15.3 displays the reach lengths in the vicinity of the weir and was activated by selecting **Tables** and then **Reach Lengths** from the **Geometric Data Editor**.

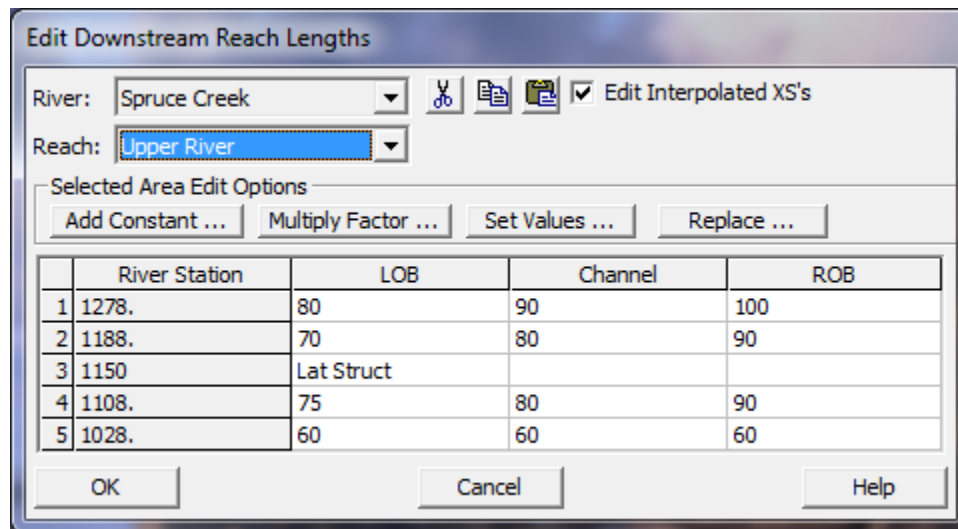

Figure 15-3: Reach Lengths in Upper River

### Lateral Structure

To add a lateral weir and gated spillways, the **Lateral Structure** icon was selected from the left side of the **Geometric Data Editor**. This activated the **Lateral Structure Editor** as shown in Figure 15.4. First, the river "Spruce Creek" and the reach "Upper River" were selected. Then, **Add a Lateral Structure** was selected from the **Options** menu, and river station 1150 was

Example 15 Lateral Weir and Gated Spillway

entered as the location for the weir. By entering the river station, the upstream end of the lateral weir is automatically placed between the cross section with the next highest river station upstream and the next lowest river station downstream. The schematic will display a profile plot of the lateral weir and any gates. When the lateral weir is first added, the schematic will be blank because the data have not yet been entered. For this example, a description of the weir was entered as "Lateral Weir and Spillway in Upper River." Underneath the description box, is the *Position* box. By clicking on the down arrow, the modeler can choose to place the lateral weir in the right or left overbank, or the right or left side of the channel. For this problem, the weir has been placed in the right overbank.

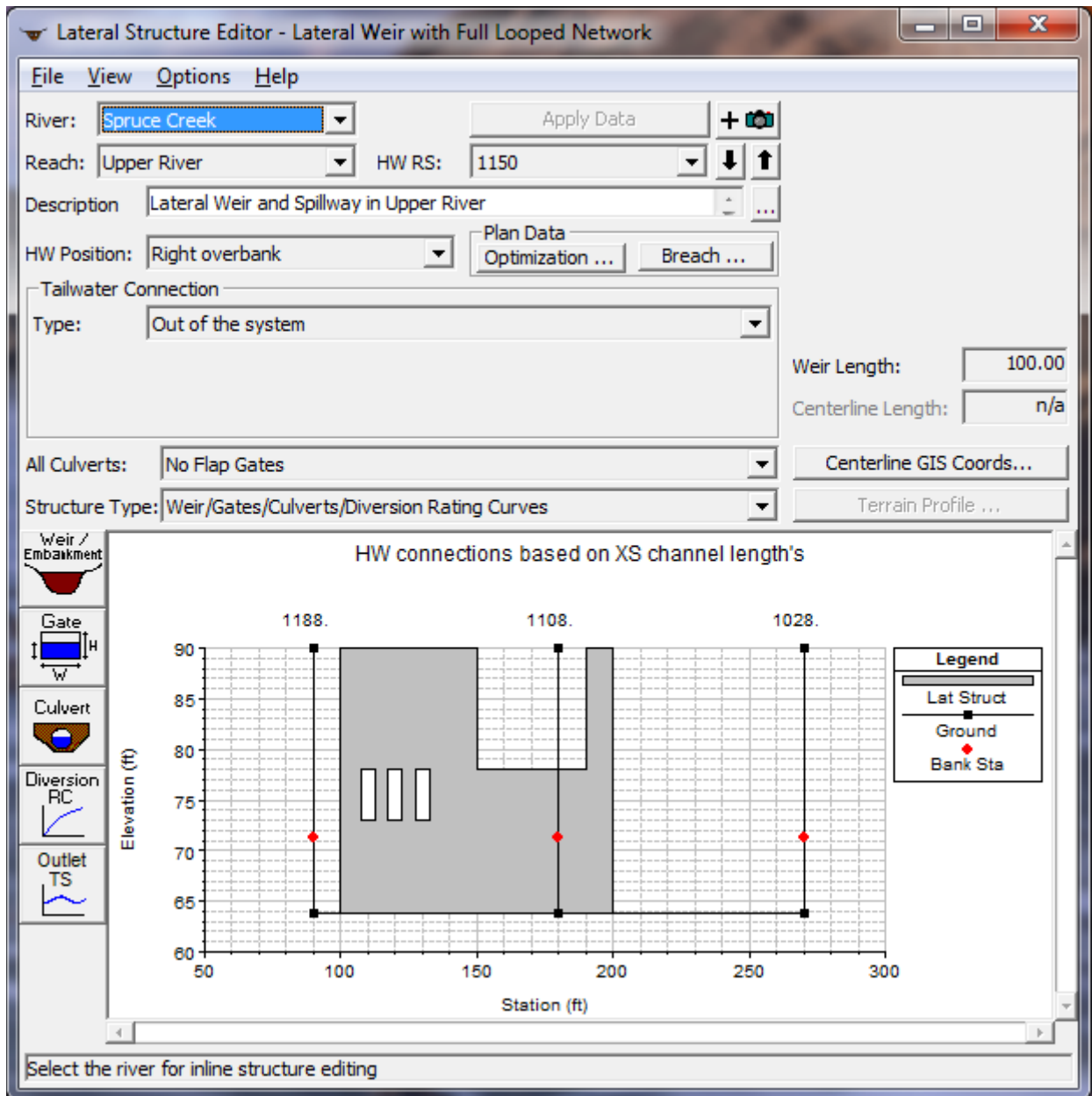

Figure 15-4: Lateral Weir Data Editor

To enter the data for the weir, the **Weir/Embankment** icon was selected from the left side of the **Lateral Weir Data Editor**. This activated the



**Lateral Weir/Embankment Editor** as shown in Figure 15.5. This editor is somewhat similar to the deck/roadway editor used for bridges and culverts.

Embankment Station/Elevation Table		
Weir Station and Elevation Filter...		
	Station	Elevation
1	100.	90.
2	150.	90.
3	150.	78.
4	190.	78.
5	190.	90.
6	200.	90.
7		
8		
9		
10		
11		
12		
13		
14		
15		
16		
17		
18		
19		
20		
21		
22		

Figure 15-5: Lateral Weir/Embankment Editor

The right hand side of the editor has two columns for the station and elevation data. These data points define the top of the lateral weir and they are entered in the upstream to the downstream direction. Similar to cross section data, the stationing for the data can be based on any horizontal datum. In this example, the weir starts at an elevation of 90 feet at an arbitrary horizontal station of 100 feet. Fifty feet downstream, the weir drops to an elevation of 78 feet. After forty feet, it returns to an elevation of 90 feet at station 190. The weir continues at an elevation of 90 feet until the final station of 200.

The left side of the editor has several fields. The first field is the *Weir Width*. This is width of the weir in the direction of flow over the weir (perpendicular to the flow in the river cross section). It is not used for hydraulic computations, but is used by the GUI for graphical purposes. In this example, it has been set to 10 feet.

The next field is labeled *Weir Computations*. This field allows the user to select from two different equations to be used in computing the lateral weir flow: the Standard Weir Equation, and Hager's Lateral Weir equation.

The next lower field is *Weir Flow Reference*. By left clicking on the down arrow, the modeler can toggle between "Energy Grade" and "Water Surface." Based on this switch, the program will compute the flow over the weir (and through any gates), using either the energy grade or the water surface when calculating the head (i.e. the depth of flow) on the weir. In this example, since the lateral weir is located in the overbank, the energy method was selected.

The next field is the *Weir Coefficient ( $C_d$ )*. It is a coefficient that is used in the computation of weir flow. It has been entered as 3.0.

The next field is *Weir Crest Shape*, and the user can select one of the following four shapes: Broad Crested; Ogee; sharp crested; or zero height weir. For this example, broad crested has been selected. If the Ogee had been selected, two additional fields and a **Cd** button would have popped up allowing the user to enter a *Spillway Approach Height* and a *Design Energy Head*. For the Ogee weir, the user can either enter a weir coefficient or have the program compute a weir coefficient by clicking on the **Cd** button.

The last field labeled *HW Distance to Upstream XS*, is used to locate the lateral structure along the stream spatially. The upstream cross section is the first normal cross section immediately upstream of the lateral weir based on river stationing. (Between two normal river cross sections, there can be one or more lateral weirs.) In this example, the upstream cross section is 1188 and the upstream end of the lateral weir is 10 feet from this cross section. So the *HW Distance* has been entered as 10 feet. The program will compute the distances to downstream cross sections based on where the lateral weir is located. In this example, the *HW Position* of the lateral weir has been specified as the right overbank (see above). This means that the program will use the right overbank reach lengths. The right overbank length (between cross sections 1188 and 1108) is 90 feet. Therefore, the lateral weir intersects the downstream cross section (river station 1108) twenty feet from the downstream end of the lateral weir.

It should be noted that the lateral weir cannot cross more than 498 cross sections. If this happens, the user should break the lateral weir into two or more weirs that are physically adjacent.

## **Gated Spillway**

To enter the data for the gates, the **Gate** icon was selected from the **Lateral Structure Data Editor** (Figure 15.4). This activated the **Gate Editor** as shown in Figure 15.6. For this example, 3 sluice gates were entered. The three gates are always to be opened (or closed) the same amount, so they were defined as a single gate group for ease of operation. If the gates were to be opened or closed individually, then each gate would be defined separately. This will be discussed further when the opening heights are set in the steady flow data editor.

After the **Gate Editor** is activated, the gate data can be entered. The *Height*, *Width*, and *Invert* for the gates were entered as 5, 5, and 73 feet, respectively. On the left side of the editor, the centerline stations for the three gates were entered as shown in Figure 15.6. As these values were entered, the counter field *# Openings* increased to represent the total number of gates (3 for this example). By default, the first, and in this example the

only, gate group is labeled as "Gate #1." This label could have been changed by clicking on the *Rename* button.

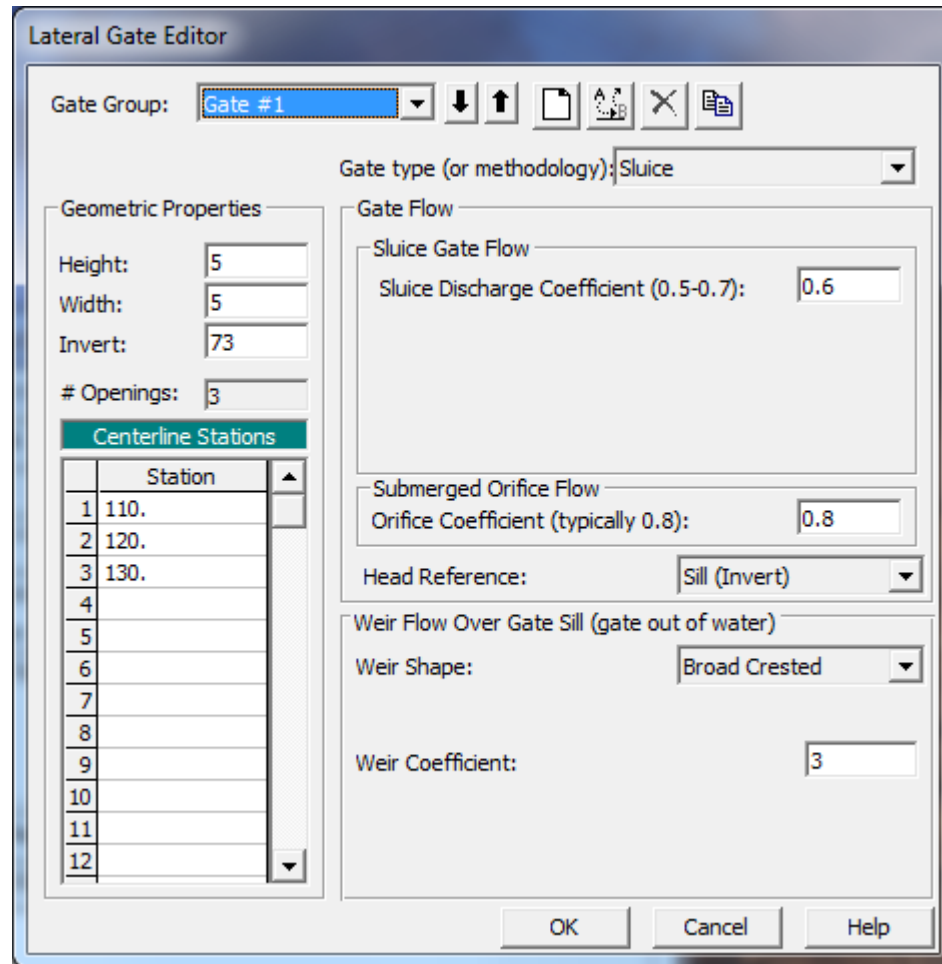

Figure 15-6: Lateral Gate Editor

The remaining portion of the editor is divided into two sections, one for the gate flow data and one for weir flow data. The gate flow data are used when the water surface upstream of the gate is greater than 1.25 times the gate opening (as measured from the gate invert). At this water surface elevation, the gate is in contact with the water and is controlling the flow rate. The weir data are used when the upstream water surface is less than or equal to the gate opening. At this water surface elevation, the weir under the gate is controlling the flow through the gate opening (i.e., the water is not in contact with the gate). In between these two elevations, the flow is in a transition zone.

For the gate flow data, the first field is the *Gate Type*. By selecting the down arrow, the type "Sluice" was chosen. When the gate type was selected, the *Trunnion Exponent*, *Opening Exponent*, and *Head Exponent* values were automatically set to 0.0, 1.0, 0.5 respectively. Since a sluice gate has been selected, the *Trunnion Height* field is not visible. The *Discharge Coefficient* was entered as 0.6. This coefficient is used when the gate is experiencing sluice flow (downstream end of the gate is not submerged). The orifice coefficient of 0.8 was entered for full flow conditions (this is used when the tailwater elevation on the gate causes it to be submerged).

For the weir flow data, the *Shape* was selected as "Broad Crested." The weir coefficient was left as 3. This information appears in the weir data area at the bottom of the **Gate Editor**.

This completed the data entry for the gates. The **OK** button was selected at the bottom of the **Gate Editor** and the gates appeared on the **Lateral Structure Data Editor** as shown in Figure 15.4. At this point, the user should zoom in on the gate openings to ensure that they do not overlap and appear as intended. The **Lateral Structure Data Editor** was then closed.

## Steady Flow Data

The flow data consisted of three components: the flow rates for each profile; the boundary conditions; and the gate elevation settings. Each of these components are described in the following sections.

### Flow Profiles

To enter the flow data, the **Steady Flow Data Editor** (as shown in Figure 15.7) was activated from the main program window by selecting **Edit** and then **Steady Flow Data**. For this example, the number of flow profiles was selected as 3. When this number was entered, the table in the central portion of the editor expanded to provide three columns for data entry, one for each profile. The table initially created four rows, one for each of the four river reaches (Bryon, Upper, Middle, and Lower Spruce). For each reach, the upstream most cross section is listed under RS (the river station). An initial flow must be given at the upstream end of each reach. An additional flow change was added to the Middle Spruce reach to model a tributary that enters this reach at station 730. (Since the water surfaces and energies in this tributary are not needed, the tributary was not included in the river schematic.) The flow change was added by clicking the appropriate down arrow to select the *River* "Spruce Creek," *Reach* "Middle River," and *River Station* "730."

As shown in Figure 15.7, the flow at the upstream most cross section (RS 1278 in Upper River) is 1500 cfs for the first profile. This 1500 cfs splits at the Meadows junction into reach Middle River and Bryon Creek. The upstream end of Bryon Creek has 1200 cfs. The upstream end of Middle River has the remaining 300 cfs. The program will use the 1200 cfs and the 300 cfs as the initial guess for the flow split at the Meadows junction. For profile 1 at river station 730 (in Middle River) the flow is listed as 350 cfs.

This means that a tributary flow of 50 cfs enters at this point. Even though the final flow in the Middle river will be different after the flow optimization, the program will maintain the 50 cfs addition at this point. This will be discussed more fully under the **Output Analysis** section below. Finally, the flow for the top of the Lower River has been entered as 1550. This represents the 1200 cfs coming from Bryon Creek and the 350 cfs (after the tributary) coming from Middle River.

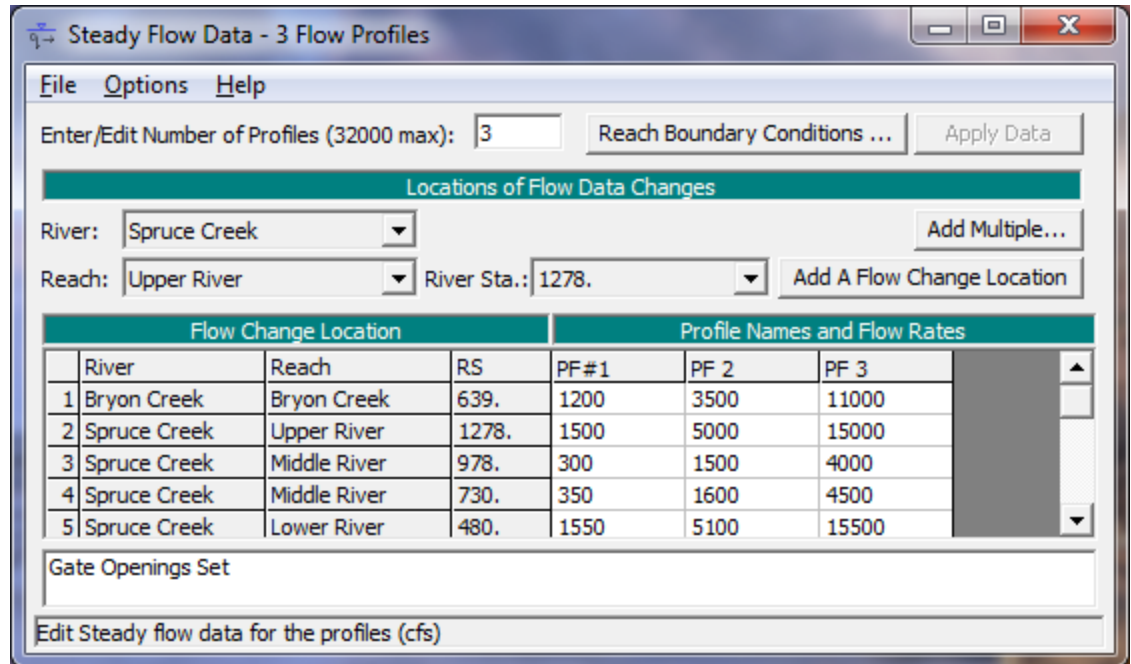

Figure 15-7: Steady Flow Data Editor

## Boundary Conditions

After the flow data were entered, the boundary conditions were entered by selecting the **Boundary Conditions** button at the top of the **Steady Flow Data Editor**. This activated the **Boundary Conditions Editor** as shown in Figure 15.8. For this example, a subcritical analysis was performed. Therefore, an external boundary condition was only needed at the downstream most cross section in reach Lower River. The field under *Downstream* was selected and then *Normal Depth* was chosen. A value of  $S = .001$  was entered. Since the *Set boundary for all profiles* has been clicked, the normal slope of 0.001 will be used for all three profiles. The upstream field of Upper River is blank, since this is a subcritical only analysis. All the remaining fields represent internal connections between different reaches and do not require any additional input from the user.

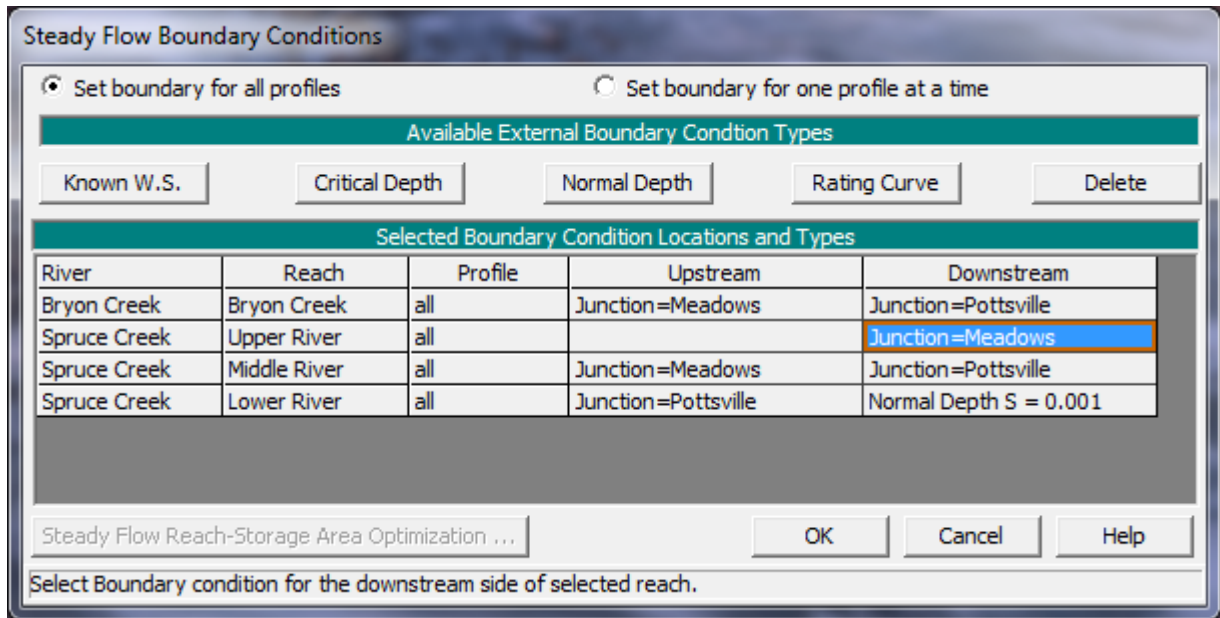

Figure 15-8: Boundary Condition Data Editor

### Gate Openings

The final data entry for the analysis was the gate opening heights. To enter this data, from the **Steady Flow Data Editor**, select **Options** and then **Gate Openings**. This activated the **Spillway Gate Openings Editor** as shown in Figure 15.9.

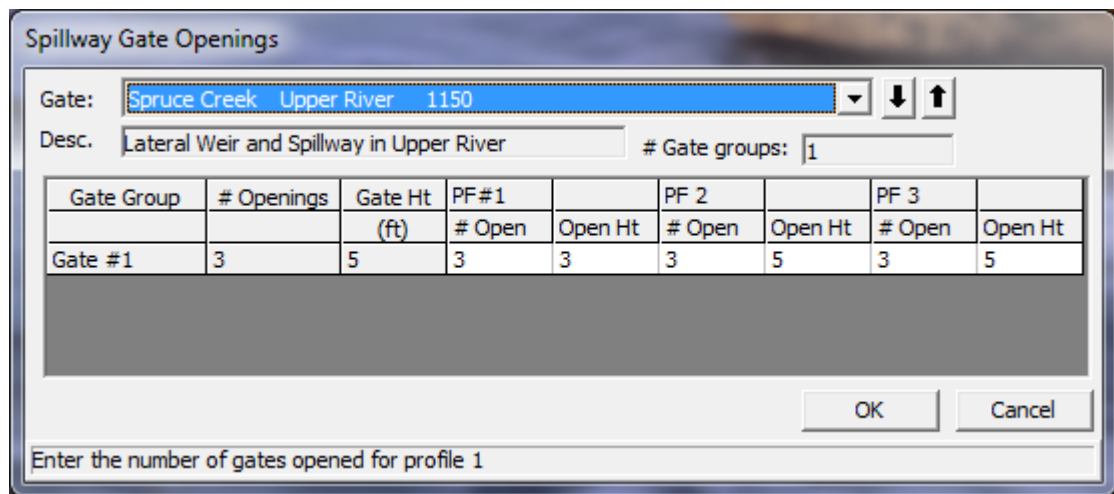

Figure 15-9: Lateral Spillway Gate Data Editor

At the top portion of the editor, the *River* "Spruce Creek," *Reach* "Upper River" and the *River Station* "1150" were selected. The *Description* is the same as was entered in the **Lateral Spillway Data Editor** (Figure 15.4). The *# Gate Groups* field shows that there is only 1 gate group at this river station. The table in the central portion of the editor has a single row for the one and only gate group. The first column lists the description for the gate group, as it was named in the **Gate Editor** (Figure 15.6). The second column displays the number of gate openings for the gate group (3). The third

column displays the maximum gate height for the gate group (5 feet for this example).

The remaining portion of the editor consists of entry fields for the number of gates opened and the opening heights of the gates for each flow profile. For the Lateral weir, all of the gates in a gate group must be operated together. For this example, for profile 1, the three gates were opened 3 feet. To close the gates, the user could set the number of gates opened to zero, or, alternately, the gate height could have been set to zero. However, if the user enters a non-zero (i.e. positive) number for the number of gates and the gate height, then the program will open all of the gates in the gate group to that height (the field for the number of gates is set up for the Inline weir where it is possible to only open part of the gates in a gate group). This means that if one gate is opened four feet, then all of the gates will be opened four feet. If the user wanted to only open one gate, then that gate would have to be defined as a separate gate group. A Lateral Weir can have a maximum of ten gate groups. So ten gates (or groups of gates) could be operated independently. If more than ten gate groups are needed, the lateral weir could be defined as two or more parts. For instance, a thousand foot long lateral weir could be defined as two 500 foot long lateral weirs. Each "weir" would have to be entered separately with its own river station and data. By choosing the appropriate *Distance to upstream cross section*, the two weirs could be placed immediately adjacent to each other. This would allow for twenty different gate groups to be operated independently.

The user can toggle across the table to view the number of gates open and the gate opening heights for all of the profiles. During the analysis of the output, the various gate settings will be discussed. This concludes the data entry for this example. At this point, the **OK** button at the bottom of the editor was selected and the flow data was saved as "3 Flow Profiles."

## Steady Flow Analysis

After all of the geometric and flow data had been entered, the **Steady Flow Analysis Window** was activated from the main program window by selecting **Run** and then **Steady Flow Analysis**. It is shown in Figure 15.10.

First, the *Short ID* was entered as "Split Flow." Next, the flow optimization flags were turned on. This was done by selecting **Options** and then **Split Flow Optimizations**. This activated the **Split Flow Optimization Editor** as shown in Figure 15.11. The tab for the lateral weir was selected by clicking on it. After clicking on it, the user can toggle between turning optimization on or off by checking the box under the "optimize" column. If the optimization flag had been left off, the program would still calculate the flow over the lateral weir. However, this flow would not be removed from the river system (this will be discussed more later).

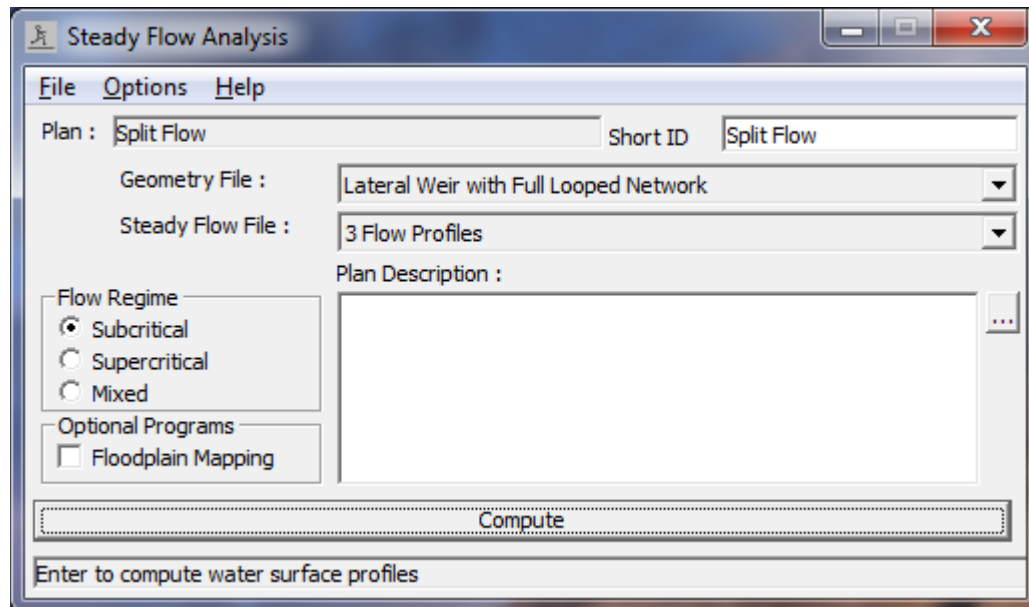

Figure 15-10: Steady Flow Analysis Editor

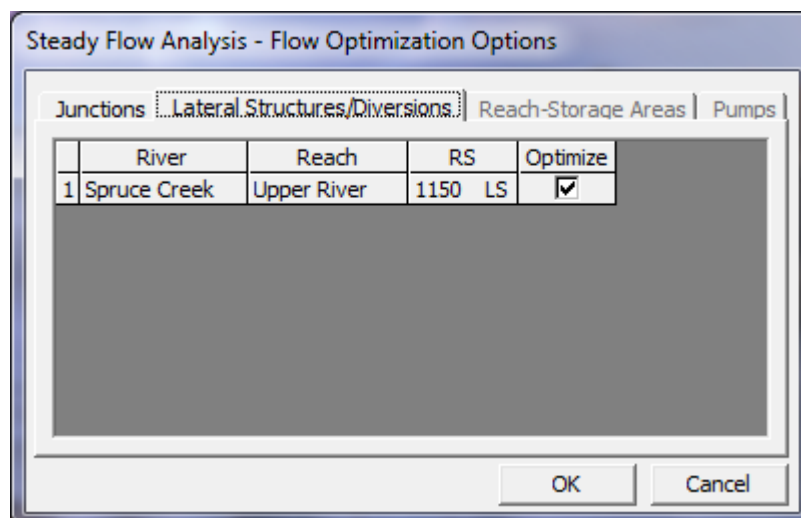

Figure 15-11: Optimization Data Editor for Lateral Weirs

Next, optimization for the junction was turned on. This was done by clicking on the *Junction* tab, which changes the **Optimization Editor** as shown in Figure 15.12. Optimization at the Meadows junction can then be toggled like it was for the lateral weir. Flow optimization can only be performed at junctions that have more than one downstream reach. For this reason, the **Editor** does not display the Pottsville junction. If the optimization flag at the Meadows junction had been left off, the program would not optimize the flow split. Rather, the program would maintain the same flow ratio in each reach.

For instance, assume that for the first profile, the junction optimization is off and that the upstream lateral weir has an outflow of 500 cfs. This means that there would be 1,000 cfs flowing into the Meadows junction instead of 1,500 cfs. The program would then proportionately reduce the flow in each reach. Middle River would be 200 cfs (instead of 300 cfs) and Bryon Creek would be 800 cfs (instead of 1,200 cfs).



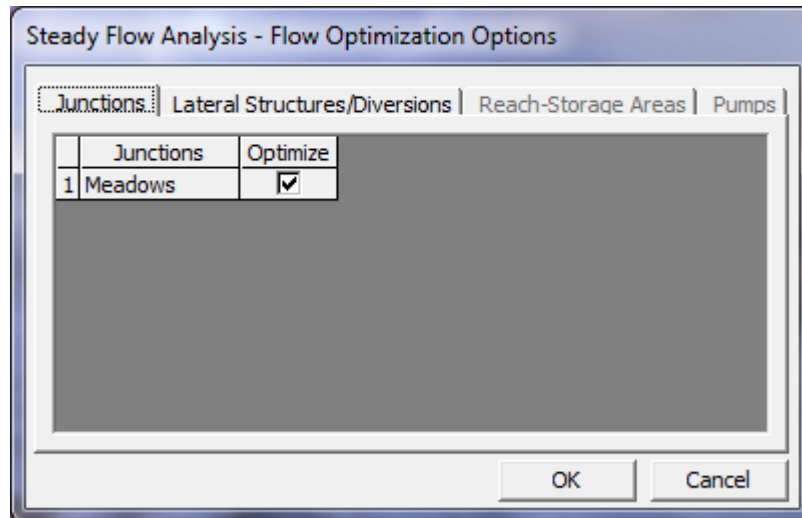

Figure 15-12: Optimization Data Editor for Junctions

Now that the optimization flags have been turned on, the files for this plan can be named and saved. First, the geometry file was selected as "Lateral Weir with Full Looped Network" and the flow file was "3 Flow Profiles." Next, the *Flow Regime* was selected as "Subcritical." Then, **File** and **Save Plan As** were chosen and the information was saved as the plan "Split Flow." This plan name then appeared on the **Steady Flow Analysis Window**, as well as on the main program window. Finally, the **COMPUTE** button was clicked to perform the analysis.

## Output Analysis

For the analysis of the output, the water surface profiles, the lateral weir type cross-section table, the lateral weir only type profile table, the junctions table, and the standard profile table will be reviewed. Each of these is described in the following sections.

### Water Surface Profiles

The water surface profiles are shown in Figure 15.13. This figure was activated from the main program window by selecting **View** and then **Water Surface Profiles**. The figure shows all three of the flow profiles. It shows all three of the reaches that make up Spruce Creek, but it does not show the Bryon Creek reach. As can be seen from the figure, the lateral weir has no flow for the first profile, flow through just the gates for the second profile, and flow through the gates and over the weir for the third profile.

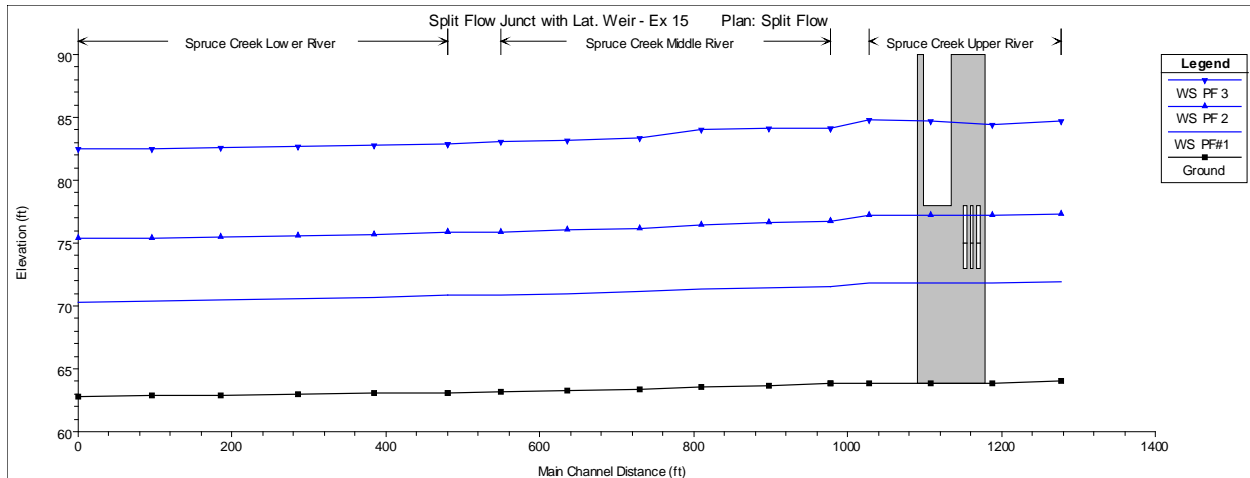

Figure 15-13: Water Surface Profiles for Spruce Creek

### Lateral Structure Detailed Output Table

To review the detailed hydraulic results for the lateral structure the Lateral **Structure** type **Detailed Output Table** was activated and is shown in Figure 15.14. This table was activated from the main program window by selecting **View, Detailed Output Table, Type**, and then **Lateral Structure**.

At the top of the table, *River* was selected as Spruce Creek, the *Reach* was selected as "Upper River" and the river station was 1150 (the node for the lateral weir). The profile was selected as "3."

The table shows the energy grade and water surface at the upstream and the downstream end of the weir. For this profile, the energy grade at the start of the lateral structure is 85.98 feet and 85.78 feet at the downstream end. The total flow upstream of the lateral structure is 15000 cfs. The total flow in the river downstream of the lateral structure is 12396.4 cfs (the lateral structure is spilling 2599.6 cfs or 17.33% of the flow). The program shows that the flow over the top of the weir is 1375.3 cfs and through the gates is 1224.3 cfs for a total of 2599.6 cfs.

In order to perform the backwater computations (and get the water surfaces and energies in the vicinity of the weir), the program must know the amount of flow in the river. To do this, it assumes the amount of flow that will be diverted by the lateral weir. This is based on the previous iteration (for this example, for the final iteration, a flow of 2612 cfs was assumed to be diverted). After the backwater calculations have been performed, the program can compute a flow for the lateral weir based on water surfaces and energies (in this case, 2599 cfs). If these two numbers are within the default tolerance of 2% (2% of the assumed 2612 cfs or 52 cfs), then the lateral weir is assumed to have converged. The default tolerances can be changed from the **Steady Flow Editor** by choosing **Options** and then selecting **Set Calculation Tolerances** (this editor is not shown).

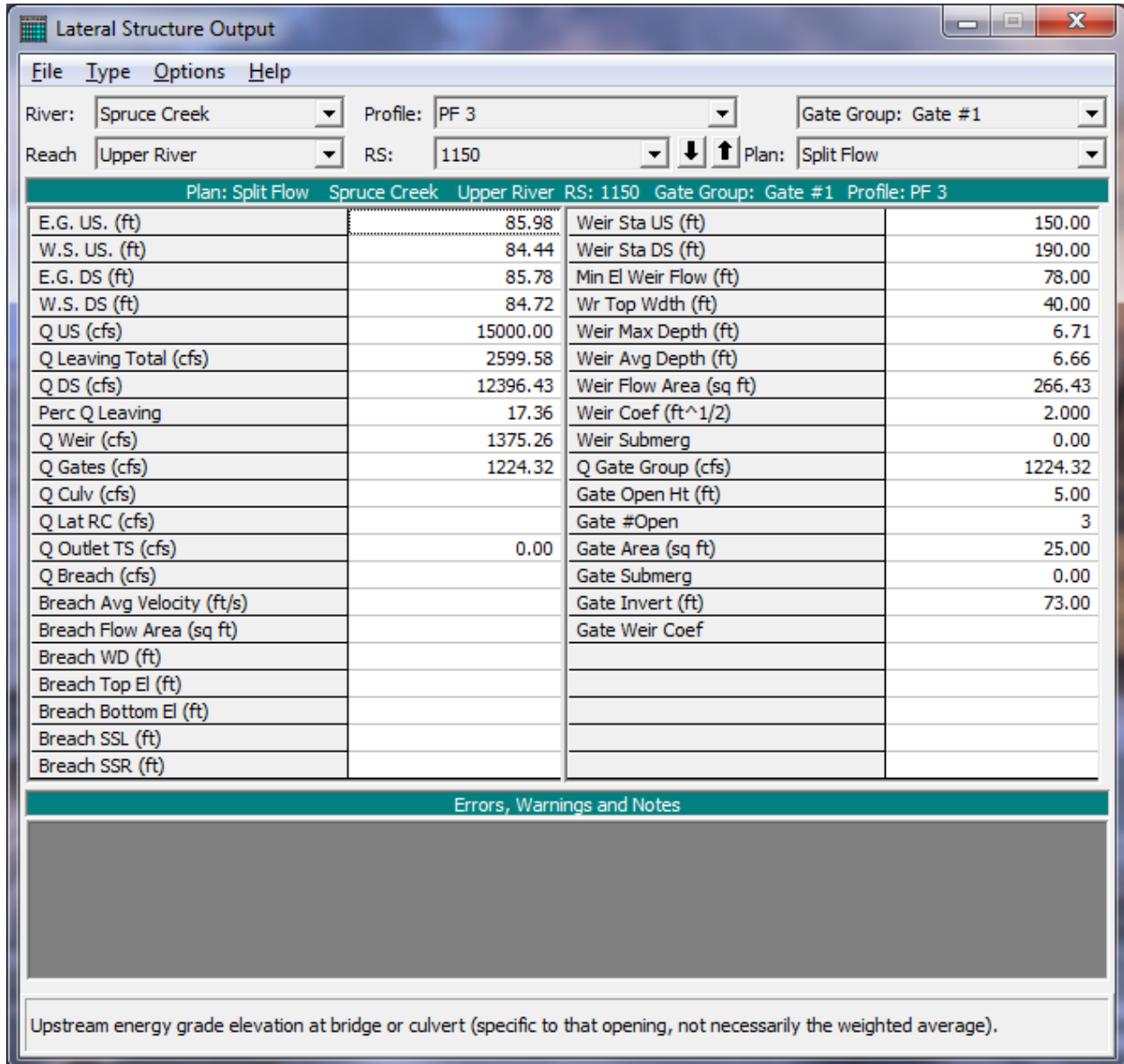

Figure 15-14:Lateral Weir Output Table for Profile 3

### Lateral Structure Profile Summary Table

The **Lateral Structure Only Profile Summary Table** is shown in Figure 15.15. This figure was activated from the main program window by selecting **View, Profile Summary Table, Std. Tables**, and then **Lateral Structure**. The figure displays the water surface elevations, energy grade line, and total weir and gate flows for each of the profiles. This table shows that gate flow occurred for the last two profiles and weir flow occurred only for the last profile. It can be used to assist in the determination of the gate settings to adjust the amount of weir flow and gate flow.

HEC-RAS Plan: Split Flow River: Spruce Creek Reach: Upper River										
Reach	River Sta	Profile	Q US (cfs)	Q Leaving Total (cfs)	Q DS (cfs)	Q Weir (cfs)	Q Gates (cfs)	Wr Top Wdth (ft)	Weir Max Depth (ft)	Weir Avg Depth (ft)
Upper River	1150	PF #1	1500.00	0.00	1500.00	0.00	0.00			
Upper River	1150	PF 2	5000.00	393.12	4609.62	0.00	393.12			
Upper River	1150	PF 3	15000.00	2599.58	12396.43	1375.26	1224.32	40.00	6.71	6.66

Flow in cross section upstream of a lateral structure.

Figure 15-15: Lateral Weir Profile Table

### Junctions Profile Summary Table

The **Junctions Only Profile Table** is shown in Figure 15.16. This figure was activated from the main program window by selecting **View, Profile Summary Table, Std. Tables**, and then **Junctions**. The figure displays the water surface elevations, energy grade lines, and total flows for each river cross-section immediately bounding the junction. This table makes it easy to check if the split flow at the junction converged. (For a given profile, the energy grade lines for the cross sections just downstream of the junction should be approximately the same. The default tolerance for junctions is 0.02 feet). It also makes it easy to see how much flow is going into each reach.

HEC-RAS Plan: Split Flow					
Reach	River Sta	Profile	W.S. Elev (ft)	E.G. Elev (ft)	Q Total (cfs)
Upper River	1028.	PF #1	71.81	72.00	1500.00
Upper River	1028.	PF 2	77.26	77.67	4609.62
Upper River	1028.	PF 3	84.82	85.70	12396.43
Junction:	Meadows				
Bryon Creek	639.	PF #1	71.46	71.94	1051.21
Bryon Creek	639.	PF 2	76.55	77.58	3167.63
Bryon Creek	639.	PF 3	83.80	85.58	8086.54
Middle River	978.	PF #1	71.53	71.93	448.79
Middle River	978.	PF 2	76.72	77.57	1441.99
Middle River	978.	PF 3	84.17	85.59	4309.89

Calculated water surface from energy equation.

Figure 15-16: Junctions Profile Table

### Standard Profile Summary Table

The **Standard Table 1** is shown in Figure 15.17. This figure was activated from the main program window by selecting **View, Profile Summary Table, Std. Tables,** and then **Standard Table 1**. For this table, only the third profile is being displayed. The flow at river station 1188, upstream of the lateral structure, is 15000 cfs. The flows at river stations 1108 and 1028 are 12745 cfs and 12396 cfs. This represents the flow diverted by the lateral structure. River station 1108 intersects the middle of the lateral weir. So for the third profile, part of the flow is diverted between river stations 1188 and 1108 and the rest is diverted between 1108 and 1028. Note also the 500 cfs increase in flow between river station 810 and 730 (from 4302 cfs to 4802 cfs) in the Middle River reach. This represents the 500 cfs inflow tributary (the tributary is not shown on the river schematic). In the **Steady Flow Editor**, the flow at river station 730 was entered as 4500 cfs for the third profile. However, due to the flow diversion from the lateral structure and the flow split at the Meadows junction, the flow in the Middle River is not constant. In this situation, the program will keep track of the relative flow change. The 4500 cfs at river station 730 is 500 cfs greater than the 4000 cfs flow at the start of the Middle River reach. Hence, the program adds 500 cfs flow at this river location.

HEC-RAS Plan: Split Flow Profile: PF 3													Reload Data
River	Reach	River Sta	Profile	Q Total (cfs)	Min Ch El (ft)	W.S. Elev (ft)	Crit W.S. (ft)	E.G. Elev (ft)	E.G. Slope (ft/ft)	Vel Chnl (ft/s)	Flow Area (sq ft)	Top Width (ft)	
Spruce Creek	Upper River	1278.	PF 3	15000.00	64.00	84.75		86.09	0.000621	9.56	1746.21	120.30	
Spruce Creek	Upper River	1188.	PF 3	15000.00	63.80	84.41		86.00	0.000753	10.40	1600.03	107.00	
Spruce Creek	Upper River	1150		Lat Struct									
Spruce Creek	Upper River	1108.	PF 3	12744.54	63.80	84.70		85.80	0.000514	8.68	1630.77	107.00	
Spruce Creek	Upper River	1028.	PF 3	12396.43	63.80	84.82		85.70	0.000402	7.78	1775.99	120.50	
Spruce Creek	Middle River	978.	PF 3	4309.89	63.80	84.17		85.59	0.001301	10.16	520.16	57.22	
Spruce Creek	Middle River	898.	PF 3	4309.89	63.63	84.09		85.48	0.001263	10.06	524.94	57.80	
Spruce Creek	Middle River	810.	PF 3	4309.89	63.54	84.00		85.36	0.001217	9.95	530.13	58.35	
Spruce Creek	Middle River	730.	PF 3	4809.89	63.41	83.33		85.20	0.001707	11.57	501.91	56.04	
Spruce Creek	Middle River	635.	PF 3	4809.89	63.28	83.17		85.03	0.001679	11.52	502.74	56.35	
Spruce Creek	Middle River	550.	PF 3	4809.89	63.15	83.06		84.88	0.001624	11.40	505.91	55.63	
Spruce Creek	Lower River	480.	PF 3	12896.43	63.12	82.88		84.79	0.001093	11.18	1213.61	100.99	
Spruce Creek	Lower River	385.	PF 3	12896.43	63.06	82.77		84.68	0.001099	11.18	1210.17	100.95	
Spruce Creek	Lower River	285.	PF 3	12896.43	62.99	82.67		84.57	0.001094	11.15	1211.66	100.94	
Spruce Creek	Lower River	185.	PF 3	12896.43	62.93	82.58		84.45	0.001077	11.07	1217.83	100.95	
Spruce Creek	Lower River	95.	PF 3	12896.43	62.86	82.51		84.34	0.001044	10.93	1230.85	100.97	
Spruce Creek	Lower River	0.	PF 3	12896.43	62.80	82.45	76.70	84.23	0.001002	10.76	1248.67	101.12	

Total flow in cross section.

Figure 15-17: Profile Standard Table 1

### Additional Adjustments

Now that the data have been entered and the program has been run, adjustments can be made to the initial flow split assumptions. Making adjustments can reduce the number of iterations that the program requires and hence speed up the computer run. This will usually be true even if other modifications are being made to the geometry file (e.g. a bridge is being

added to one of the river reaches). In some cases, a data set that is not converging can be modified to one that will converge.

### Junction Flow Split

Figure 15.16. above, shows the flow split at the Meadows junction. For the third profile, Middle River has 4302 cfs and Bryon Creek has 8085 cfs. The 4302 cfs is around 35% of the total flow at the Meadows junction. However, the original data, in the **Steady Flow Editor**, shows that Middle River has 4000, which is around 25% of the original 15000 cfs flow at Meadows (Bryon Creek has the remaining 11000 cfs). Adjusting this flow to be closer to 35% of the total will speed up the convergence process. In this case a value of 5000 cfs for Middle River and 10000 cfs for Bryon Creek would improve the run time (and increase the chances of successful convergence). Note that it would be incorrect to simply enter the 4302 cfs for Middle River and 8085 cfs for Bryon Creek in the **Steady Flow Editor**. If this were done, then the program would assume that a flow loss was taking place at the Meadows junction. Note also that if the flow in the Middle River is changed to 5000, then the flow at 730 should be changed to 5500 to maintain the 500 cfs increment.

### Lateral Structure Flow Split

The user can also enter a first guess for the amount of flow that will be diverted by the lateral structure. As in the case of a junction, this can improve the run performance. To enter this data, from the **Steady Flow Data Editor, Options** and then **Initial Split Flow Optimization** were selected. This activated the **Initial Lateral Flow Splits Editor** as shown in Figure 15.18. By clicking under the *Initial Flow* field for the appropriate profile, a first guess for the lateral weir flow can be entered. The program will then assume that this much flow is diverted when it performs the first iteration of the backwater calculations.

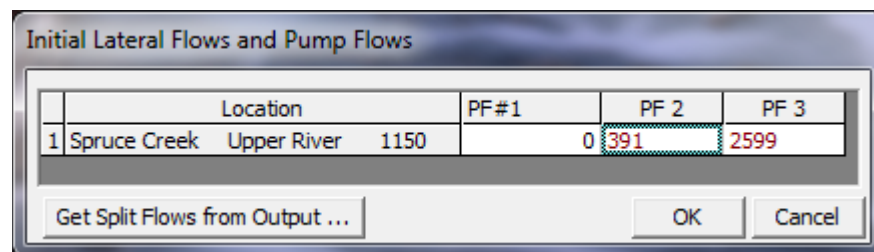

Figure 15-18: Initial Lateral Flow Split Data Editor

## Summary

This example computed 3 flow profiles for the Bryon Creek and Spruce Rivers. It included a lateral weir with gates and a fully looped river network between the Meadows and Pottsville junction.

By reviewing the lateral weir and junction tables and the water surface profiles and tables, the user can determine the amount of flow being diverted by the lateral weir and the amount of flow being split into the two reaches

downstream of the Meadows junction. The **Lateral Weir/Spillway Output** table provides detailed output for the lateral weir, for a given profile. The **Junctions** table provides flow split output for one or more profiles. The user can also adjust the initial starting conditions to improve the run performance of the computer computations.





## CHAPTER 16

# Channel Modification

### Purpose

This example demonstrates the use of HEC-RAS to perform a channel modification on an existing channel geometry using a series of trapezoidal cuts. Water surface profiles resulting from a channel modification can be compared to water surface profiles resulting from the existing channel geometry.

The user is referred to Chapter 12 of the **User's Manual** for discussion on modifying the existing geometric data, implementing the new channel geometry, and comparing existing and modified conditions.

To review the data files for this example, from the main HEC-RAS window, select **File** and then **Open Project**. Go to the directory in which you have installed the HEC-RAS example data sets. From the "Applications Guide\Chapter 16 – Channel Modification" subdirectory, select the project labeled "Channel Modification - Example 16." This will open the project and activate the following files:

Plan:	"Existing Conditions"
Geometry:	"Base Geometry Data"
Flow:	"100 Year Profile"

### Geometric Data

To view the geometric data for the river system, from the main program window select **Edit** and then **Geometric Data**. This will activate the **Geometric Data Editor** and display the river system schematic as shown in Figure 16.1.

### Channel Modification Data

To perform a modification on the channel, select **Channel Modification (Original One)** from the **Tools** menu of the **Geometric Data Editor**. This will activate the window shown in Figure 16.2. The data displayed in Figure 16.2 is not present upon entering a new channel modification window. The

data shown in the left hand column of Figure 16.2 is used to construct the cuts for each cross section.

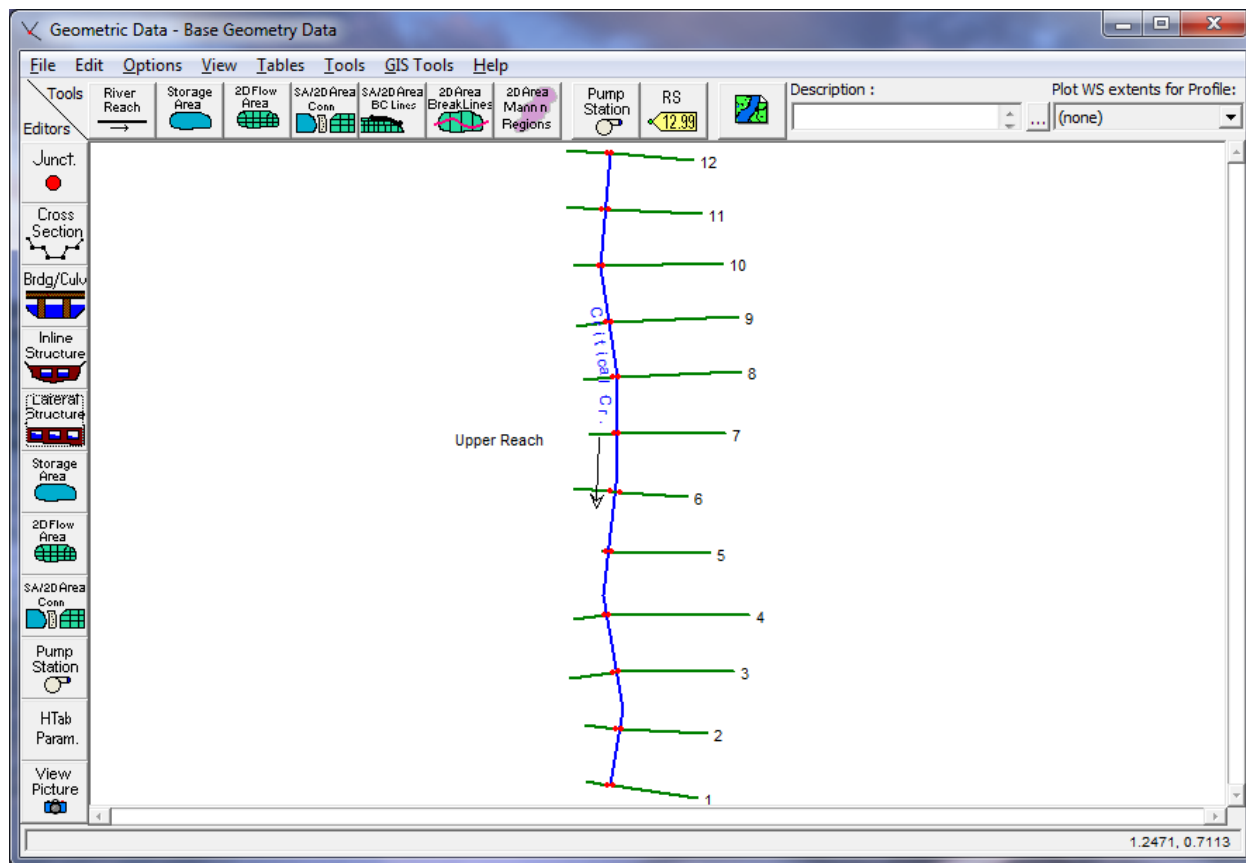

Figure 16-1: River System Schematic for Base Geometry Data

The channel modification began with the **River** set to “Critical Creek” and the **Reach** set to “Upper Reach.” The **Starting River Station** was set by default to 12 and the **Ending River Station** was changed to a value of 1, the downstream end of this particular reach. The **Project cut from upper RS at slope** option was entered as 0.01. This option projects a cut using the specified slope from the invert elevation of the **Starting River Station**.

Once the correct river stations were set, the first cut was established. The **Center Cuts (y/n) column** in the **Set Range of Values** table was entered as “y.” This set the centerline for the first cut at the centerline of the main channel. Next, “100” was entered in the **Bottom Width** column to set the width of the first cut to 100 feet along the centerline. The **Invert Elevation** column was left blank for the first cut, which defaults the program to the existing invert elevation of the **Starting River Station**. Both side slopes for the banks were entered as 2 (2 horizontal to 1 vertical). The **Cut n/K** column for the new Manning’s n-value was entered as 0.025.

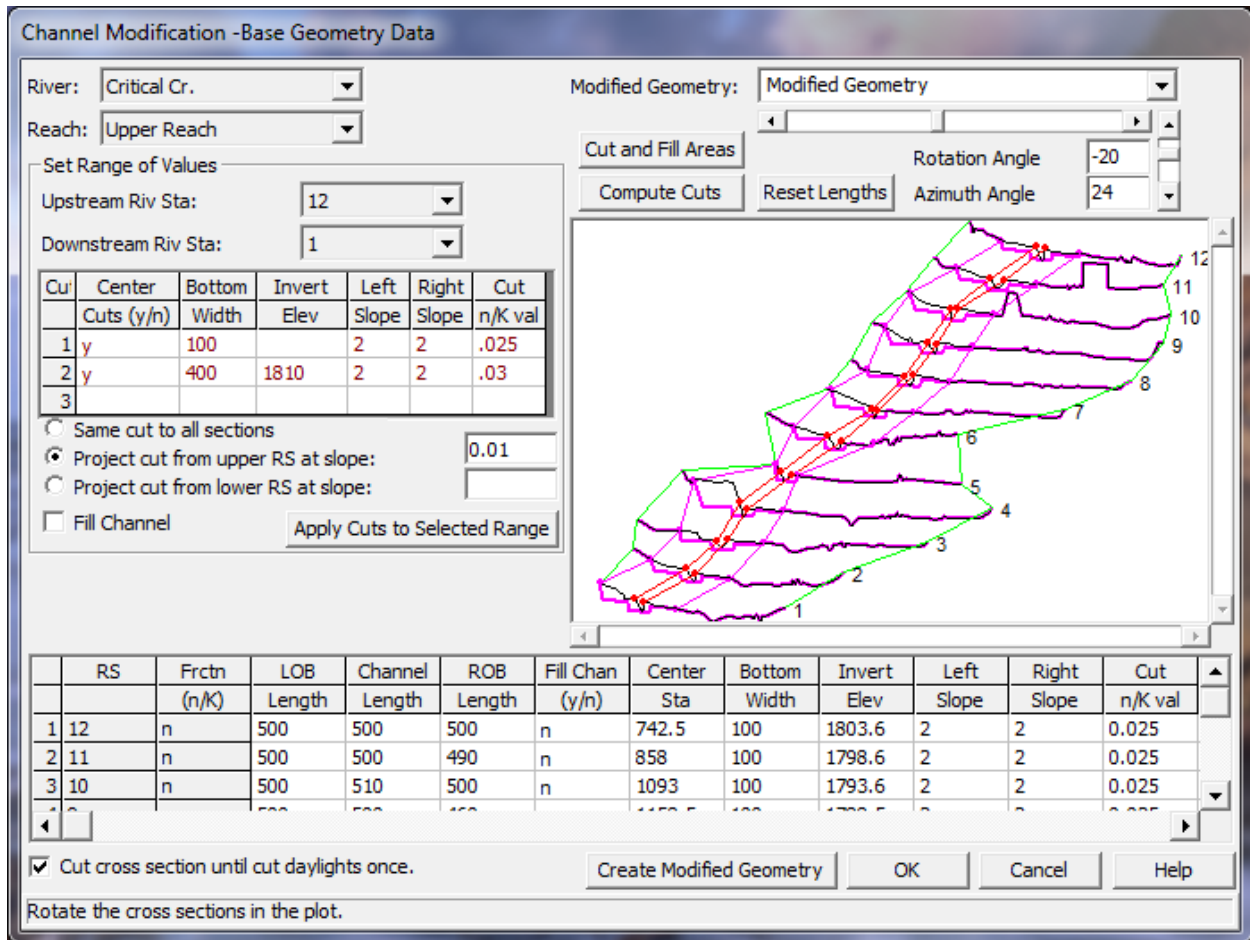

Figure 16-2: Channel Modification Window

The second cut was also done on the existing centerline of the main channel. A **Bottom Width** of 400 feet and an **Invert Elevation** of 1810 feet were entered. The entry initiated the second cut at an elevation of 1810 feet, at the **Starting River Station**. The cut will then project with the specified slope from this elevation. The slopes were again entered with a value of 2 and Manning’s n-value was entered as 0.03. After the data was entered, the **Apply Cuts to Selected Range** button was pressed to compute the data shown in the lower table of Figure 16.2.

An option available to the user is **Cut cross section until cut daylight**s. For this particular example this option was selected. As the program performs the cutting of the trapezoidal channel, the left and right banks of the channel will initiate at the invert elevation and cut through the ground until they reach open air, then the cutting will stop. If this option is turned off, the left and right banks of the trapezoid will be projected to infinity, continually cutting any ground that lies above them.

### Performing the Channel Modifications

After the **Apply Cuts to Selected Range** was selected, the **Compute Cuts** button was pressed. This applied all of the channel modification data from the lower table to the graphic, updating the information. Additionally, the **Cut and Fill Areas** button was pressed to display Figure 16.3

The Cut and Fill Data displays the area and volume of each individual cut for the left overbank, main channel, and right overbank. The table also displays the total area and volume for each individual cut as well as the total volume for the entire reach.

River:	Critical Cr	Reach:	Upper Re:						
RS		Area L	Area Ch	Area R	Area T	Volume L	Volume Ch	Volume R	Volume T
		(sq ft)	(sq ft)	(sq ft)	(sq ft)	(cu yd)	(cu yd)	(cu yd)	(cu yd)
12	Cut	642	195	1060	1897	11261	5107	19945	36313
	Fill	0	0	0	0	0	0	0	0
	Net	642	195	1060	1897	11261	5107	19945	36313
11	Cut	574	357	1094	2025	12827	5220	22938	40986
	Fill	0	0	0	0	0	0	0	0
	Net	574	357	1094	2025	12827	5220	22938	40986
10	Cut	811	207	1434	2452	12913	3884	24560	41357
	Fill	0	0	0	0	0	0	0	0

Figure 16-3: Cut and Fill Areas

### Saving the Channel Modifications

After the completion of all channel modifications a new geometry file was created. From the **Channel Modifications Data Window**, Figure 16.2, the title "Modified Geometry" was entered in the upper right hand window. Next, the button **Create Modified Geometry** was pressed and the file was saved. Finally, the original geometry file was saved to the hard disk by selecting **Save Geometry Data** from the **Geometric Data Editor**. This step was needed because the data entered in the **Channel Modification Data Window** is saved in the base geometry file and not the modified geometry file. Hence, when the modified geometry file was saved, the modifications which were used to create that file had not yet been saved.

## Steady Flow Analysis

After saving all the geometric data, the steady flow data file was created. From the main program window, **Edit** and then **Steady Flow Data** were selected. This activated the **Steady Flow Data Window** shown in Figure 16.4. Profiles were selected with flows of 9000 cfs at river station 12 and 9500 cfs at river station 8. The upstream and downstream boundary conditions were established as "Normal Depth = 0.01." This steady flow data file is identical to the file produced in Example 1. The user is referred to Example 1 for a further discussion on developing a steady flow data file.

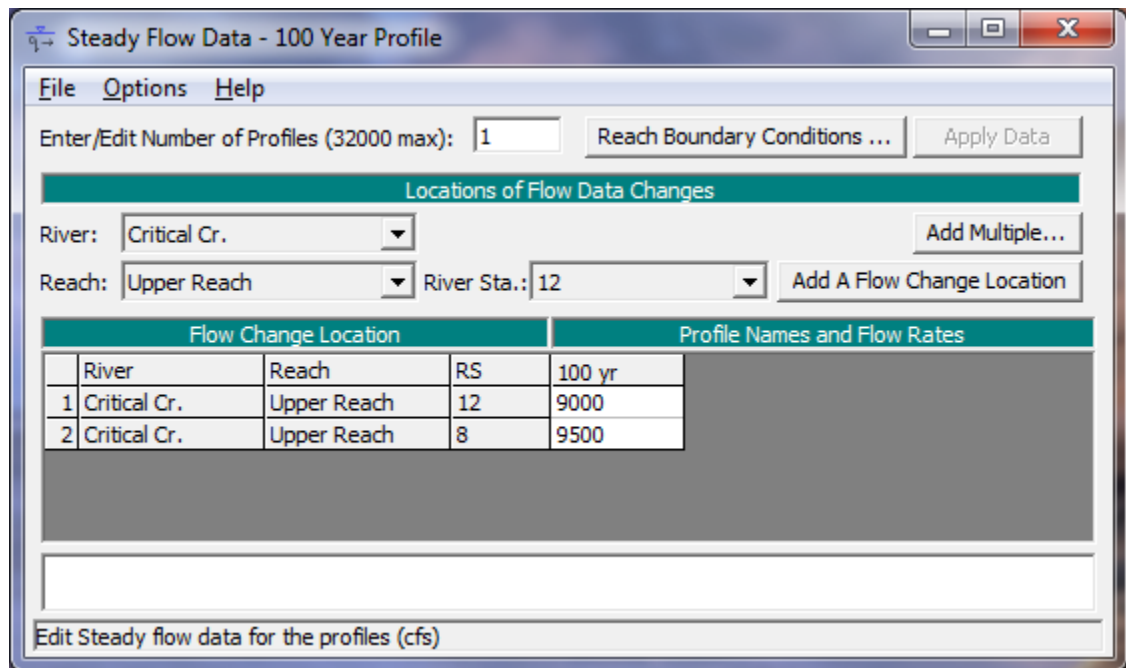

Figure 16-4: Steady Flow Data Window

## Comparing Existing and Modified Conditions

Plans for the different geometry files must be manufactured before a comparison can be analyzed. Once the plans are created the user can view the graphical and tabular results.

### Steady Flow Analysis

A new plan was created by selecting **Run** and then **Steady Flow Analysis** from the main program window. This activated the **Steady Flow Analysis Window** shown in Figure 16.5. The **Geometry File** was selected as "Base Geometry Data" and the **Steady Flow File** was selected as "100 Year Profile." Next, a new plan was created by selecting **New Plan** from the **File**

menu. The title was entered as "Existing Conditions," and the **Short I.D.** was entered as "Exist Cond." A mixed **Flow Regime** was selected and the file was saved by choosing File and then Save Plan. Finally, the Compute button was selected to perform the steady flow analysis.

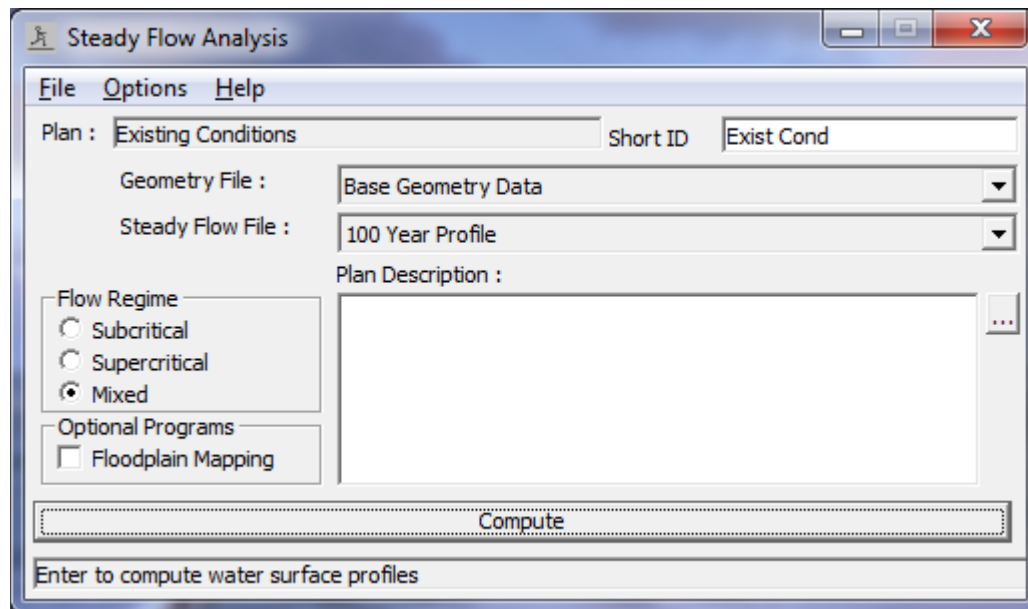

Figure 16-5: Steady Flow Analysis Window

This procedure was repeated for the modified channel geometry. On the **Steady Flow Analysis Window** the **Geometry File** was selected as "Modified Geometry" and the **Steady Flow File** remained "100 Year Profile." The **Flow Regime** was changed to "Supercritical." The title was entered as "Modified Conditions Run" and the **Short I.D.** was entered as "Modified." The file was saved and then the **Compute** button was selected.

## Water Surface Profiles

After the simulation was completed, **Water Surface Profiles** was selected from the **View** menu on the main program window. To compare the different profiles for the existing and modified channel geometry, **Options** and then **Plans** was selected from the profile plot. This displayed the **Plan Selection Window**. From this window the check box **Compare Geometry as well as Output** was selected and the existing and modified geometry plans were selected for comparison, as shown on Figure 16.6.

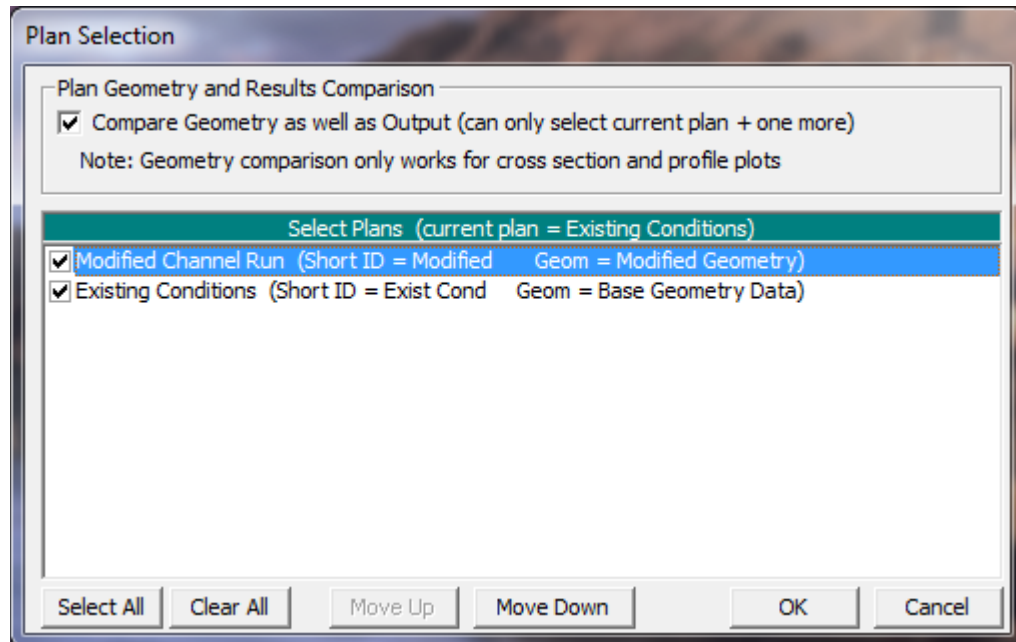

Figure 16-6: Plan Selection Window

After pressing the **OK** button on the **Plan Selection Window**, Figure 16.7 was displayed. The figure shows the two plans for the existing channel geometry and the modified channel geometry. It can be seen from the profile that the existing channel geometry had a flow that was mixed between the subcritical and supercritical regime. The modified channel geometry altered the flow to be exclusively supercritical for this reach.

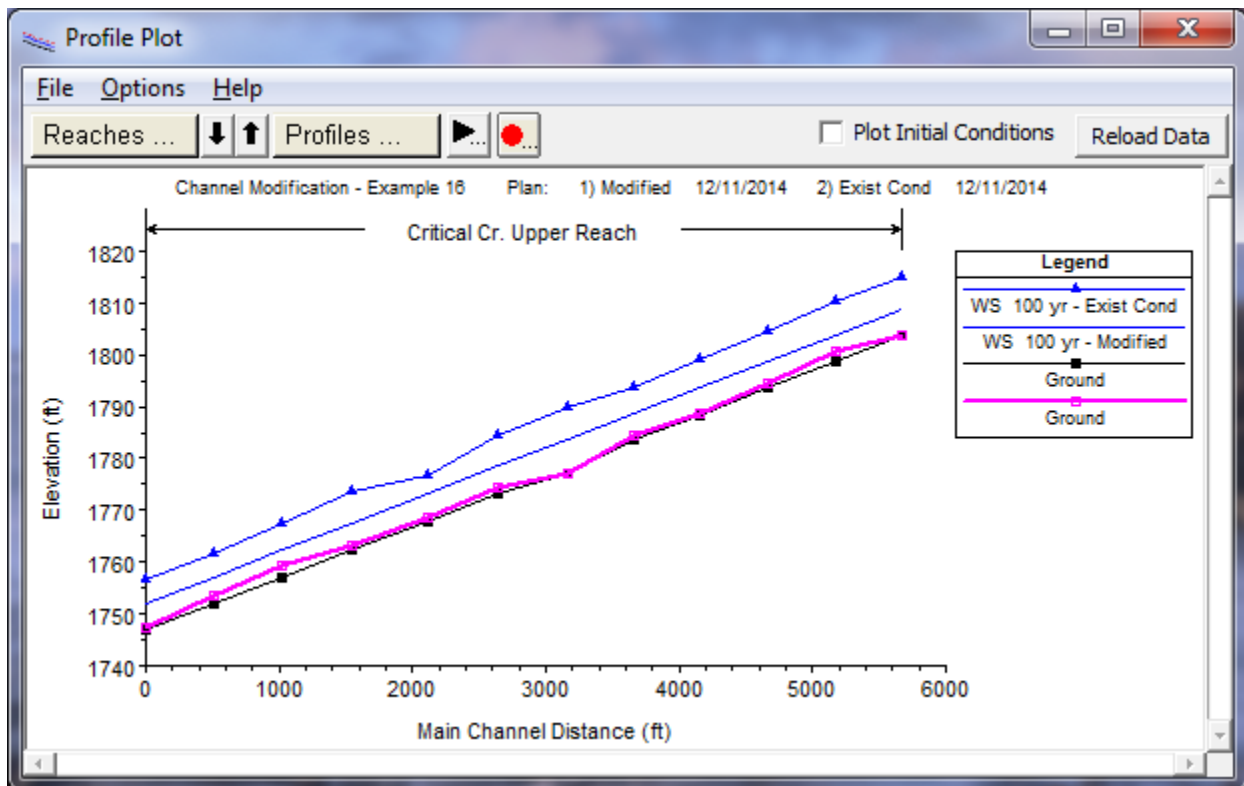

Figure 16-7: Water Surface Profiles showing existing and modified geometry

### Cross Section Plots

From the main program window, select **View** and then **Cross Section**. The same method illustrated in the previous section was used for selecting the existing and modified plans. The cross section plot illustrated in Figure 16.8 displays the existing and modified channel geometry along with the water surface profiles for both plans. As seen from the figure, the channel modification lowered the water surface for the 100-year event. For the modified geometry the water surface level was lowered enough to contain the 100-year flow in the main channel. In addition, the channel modifications changed the type of flow from subcritical to supercritical at this particular cross section.



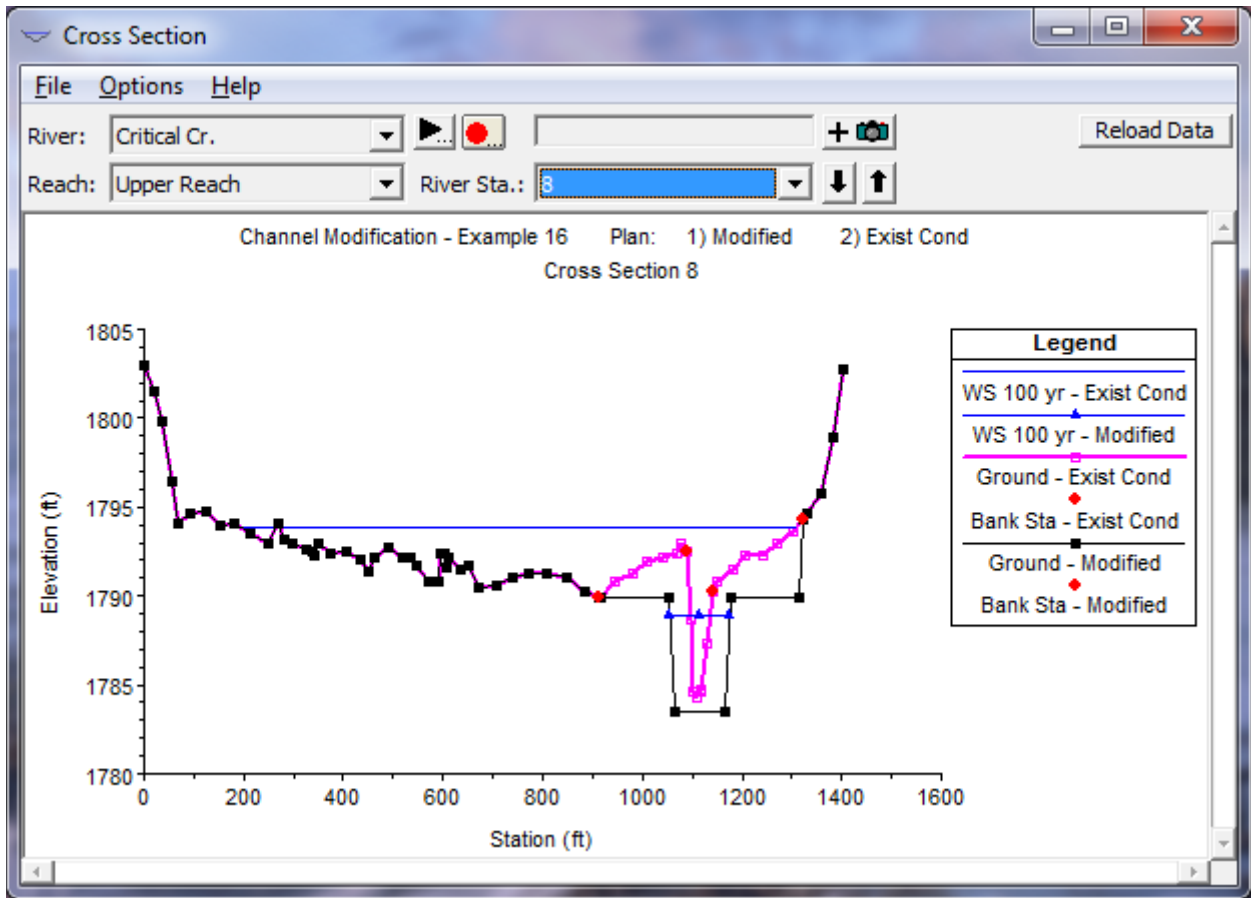

Figure 16-8: Cross Section showing existing and modified geometry

### X-Y-Z Perspective Plot

From the main program menu select **View** and the **X-Y-Z Perspective Plots**. Figure 16.9 displays the 3D plot from river station 12 to river station 1. The user can select various azimuth and rotation angles to obtain differing views of the reach. The figure shows the difference in lateral distribution of the water surfaces for the existing and modified channel geometry for the given flow data.

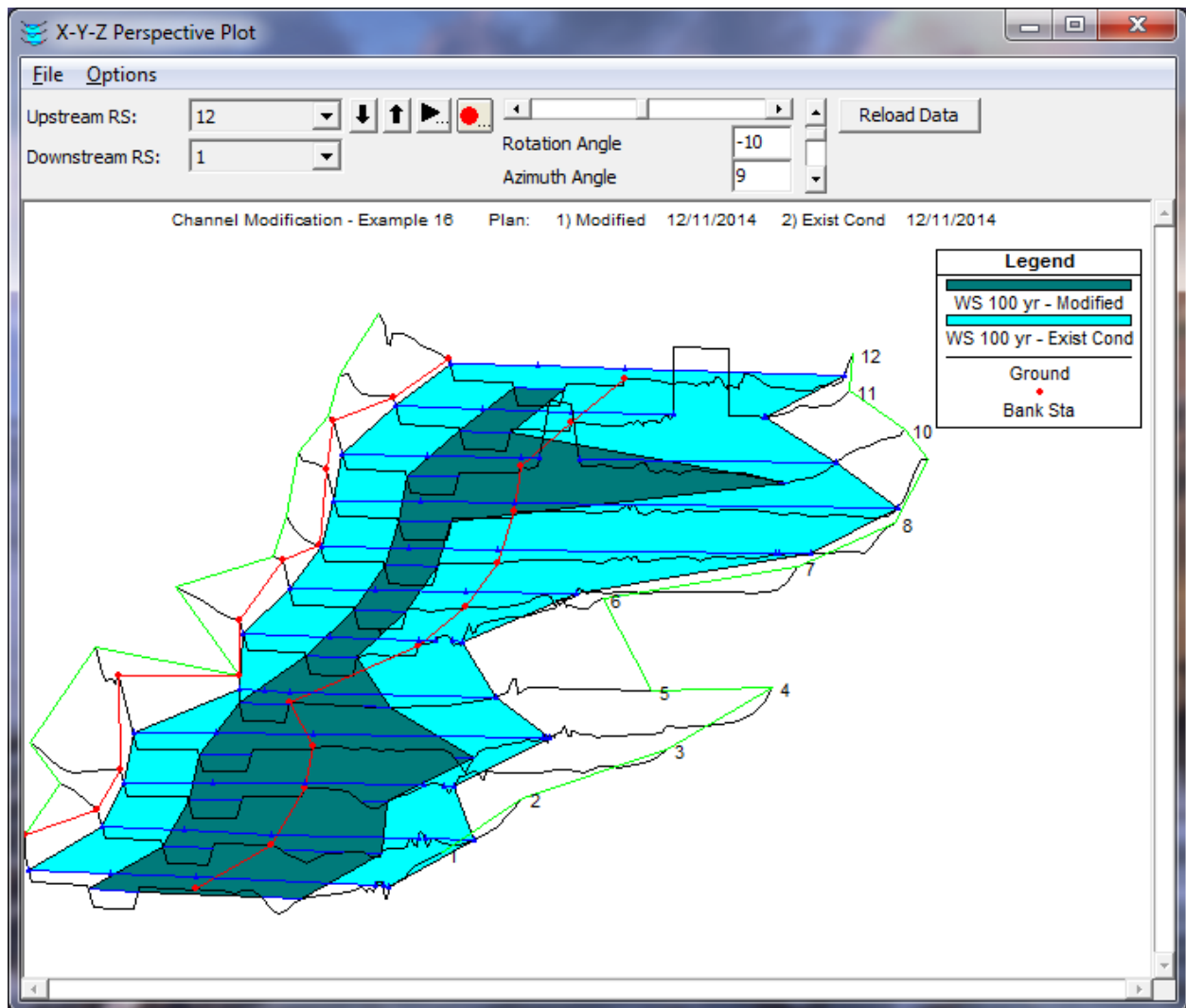

Figure 16-9: X-Y-Z Perspective Plot

### Standard Table

In addition to graphical display, the user can compare the output in tabular form. From the main program window, select **View** and then **Profile Summary Table**. By selecting **Standard Table 1**, the table shown in Figure 16.10 is displayed. The first two columns of the table display the river reach and river station. The third column identifies which plan corresponds to the data. The identifiers in this column are obtained from the **Short ID** entered in the **Steady Flow Data Editor**. The remaining portion of the table displays information about total flow, energy grade line elevation, water surface elevation, etc.

As shown in the table the modifications lowered the water surface by approximately 5 feet. The table also shows the transformation of flow from the subcritical regime, for the existing conditions, to a supercritical regime for the modified conditions. This corresponds with the increase in velocity.

HEC-RAS River: Critical Cr. Reach: Upper Reach Profile: 100 yr													
Reach	River Sta	Profile	Plan	Q Total (cfs)	Min Ch El (ft)	W.S. Elev (ft)	Crit W.S. (ft)	E.G. Elev (ft)	E.G. Slope (ft/ft)	Vel Chnl (ft/s)	Flow Area (sq ft)	Top Width (ft)	Froude # Chl
Upper Reach	12	100 yr	Modified	9000.00	1803.60	1808.63	1810.68	1812.74	0.010005	16.25	553.74	120.12	1.33
Upper Reach	12	100 yr	Exist Cond	9000.00	1803.60	1815.06	1814.46	1815.76	0.006855	10.51	2557.91	878.49	0.69
Upper Reach	11	100 yr	Modified	9000.00	1798.60	1803.64	1805.68	1807.73	0.009970	16.24	554.35	120.14	1.33
Upper Reach	11	100 yr	Exist Cond	9000.00	1800.70	1810.42	1810.42	1811.87	0.008544	12.03	1735.43	562.66	0.82
Upper Reach	10	100 yr	Modified	9000.00	1793.60	1798.63	1800.68	1802.74	0.010033	16.27	558.21	143.91	1.34
Upper Reach	10	100 yr	Exist Cond	9000.00	1794.40	1804.47	1803.69	1804.98	0.010255	10.48	2479.90	914.78	0.79
Upper Reach	9	100 yr	Modified	9000.00	1788.50	1793.53	1795.57	1797.63	0.009983	16.24	554.13	120.14	1.33
Upper Reach	9	100 yr	Exist Cond	9000.00	1788.70	1799.31	1799.31	1800.16	0.008846	11.48	2720.40	1216.83	0.80
Upper Reach	8	100 yr	Modified	9500.00	1783.50	1788.84	1790.68	1792.85	0.009090	16.06	591.37	121.37	1.28
Upper Reach	8	100 yr	Exist Cond	9500.00	1784.30	1793.66	1793.89	1795.19	0.010933	13.65	2271.67	1084.76	0.91
Upper Reach	7	100 yr	Modified	9500.00	1777.20	1783.66	1785.57	1787.92	0.010616	16.57	573.36	120.64	1.34
Upper Reach	7	100 yr	Exist Cond	9500.00	1777.20	1789.88	1788.87	1791.00	0.007413	13.16	2155.24	526.60	0.76
Upper Reach	6	100 yr	Modified	9500.00	1773.30	1778.59	1780.40	1782.69	0.009398	16.24	585.03	121.16	1.30
Upper Reach	6	100 yr	Exist Cond	9500.00	1774.50	1784.30	1784.30	1786.35	0.011132	13.38	1266.83	332.46	0.93

Total flow in cross section.

Figure 16-10: Profile Output Table

## Summary

The geometry of Example 1 was modified to prevent the flow from the 100-year event from overflowing the channel. This was accomplished by modifying the existing channel conditions to include two cuts down the centerline of the channel. By reviewing the water surface profiles and tables, the user can determine the benefits of a specific channel modification for a given flow.



## CHAPTER 17

# Unsteady Flow Application

## Purpose

This example demonstrates the use of HEC-RAS to perform an unsteady flow analysis on a network of reaches containing junctions, storage areas, bridges, culverts, and hydraulic connections. The geometric data constructed for this example illustrates multiple unsteady flow applications in HEC-RAS. The geometric data used in this example is not a specific reference to any existing stream network.

This example focuses on modeling and evaluating storage areas, hydraulic connections, and hydraulic parameters in an unsteady flow environment. The user is referred to previous examples for discussion on modeling bridges, culverts, multiple reaches, and junctions.

To review the data files for this example, from the main HEC-RAS window, select **File** and then **Open Project**. Go to the directory in which you have installed the HEC-RAS example data sets. From the "Applications Guide\Chapter 17 – Unsteady Flow Application" subdirectory, select the project labeled "Unsteady Flow Application." This will open the project and activate the following files:

Plan:	"Diamond River Base Plan"
Geometry:	"Diamond River Base Geometry"
Unsteady Flow:	"Unsteady Flow"

## Geometric Data

To view the geometric data for the river system, from the main program window select **Edit** and then **Geometric Data**. This will activate the **Geometric Data Editor** and display the river system schematic as shown in Figure 17.1.

## General Description

The Geometric Data consists of a network of channels connected by junctions. Four storage areas are included in the geometry (Pyramid Lake, Eagle Lake, Upper Angora, and Lower Angora). Pyramid Lake is connected by two

reaches (East and West) and by Eagle Lake, via a culvert and a weir. Eagle Lake is hydraulically connected to River Station 1.9 on the Southeast Reach and to the previously mentioned Pyramid Lake. Upper Angora is connected to the Southwest Reach via a lateral weir located between cross sections 1.99 and 1.9. Lower Angora is hydraulically connected to Upper Angora via a culvert and a weir.

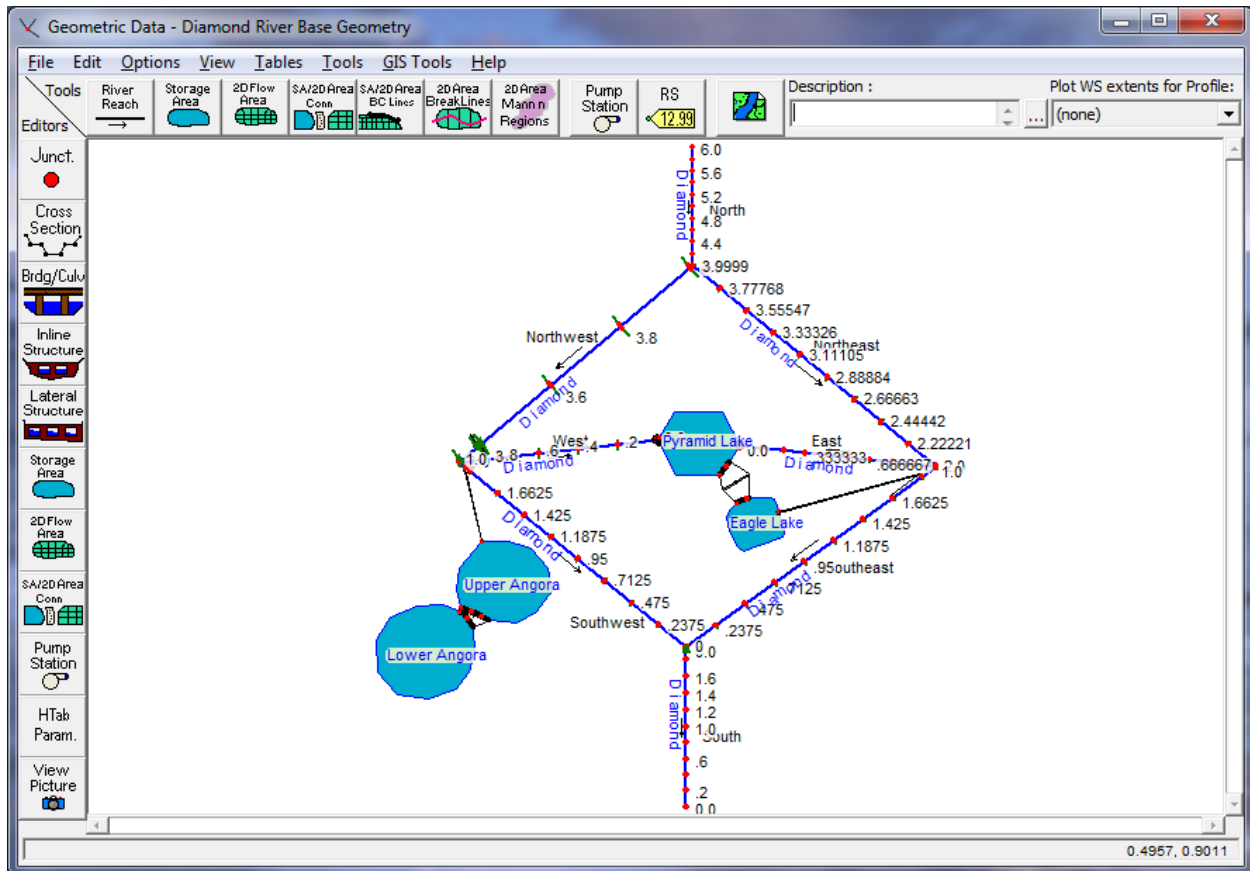

Figure 17-1: River System Schematic for Diamond River Base Geometry

In addition to these features, a culvert is located at River Station 3.395 on the Northwest Reach and a bridge is located at River Station 1.895 on the South Reach. The cross section geometry is prismatic with little change in elevation with distance except for the North Reach. The level topography provides an excellent environment to examine unsteady flow for such aspects as flow reversal.

This example assumes that the user has sufficient experience constructing the following river system features and all attributes associated with each feature.

- Reaches
- Cross Section Geometry
- Junctions

- Bridges and Culverts

Consult with previous examples for information pertaining to the above mentioned features. The following description commences with the creation of storage areas.

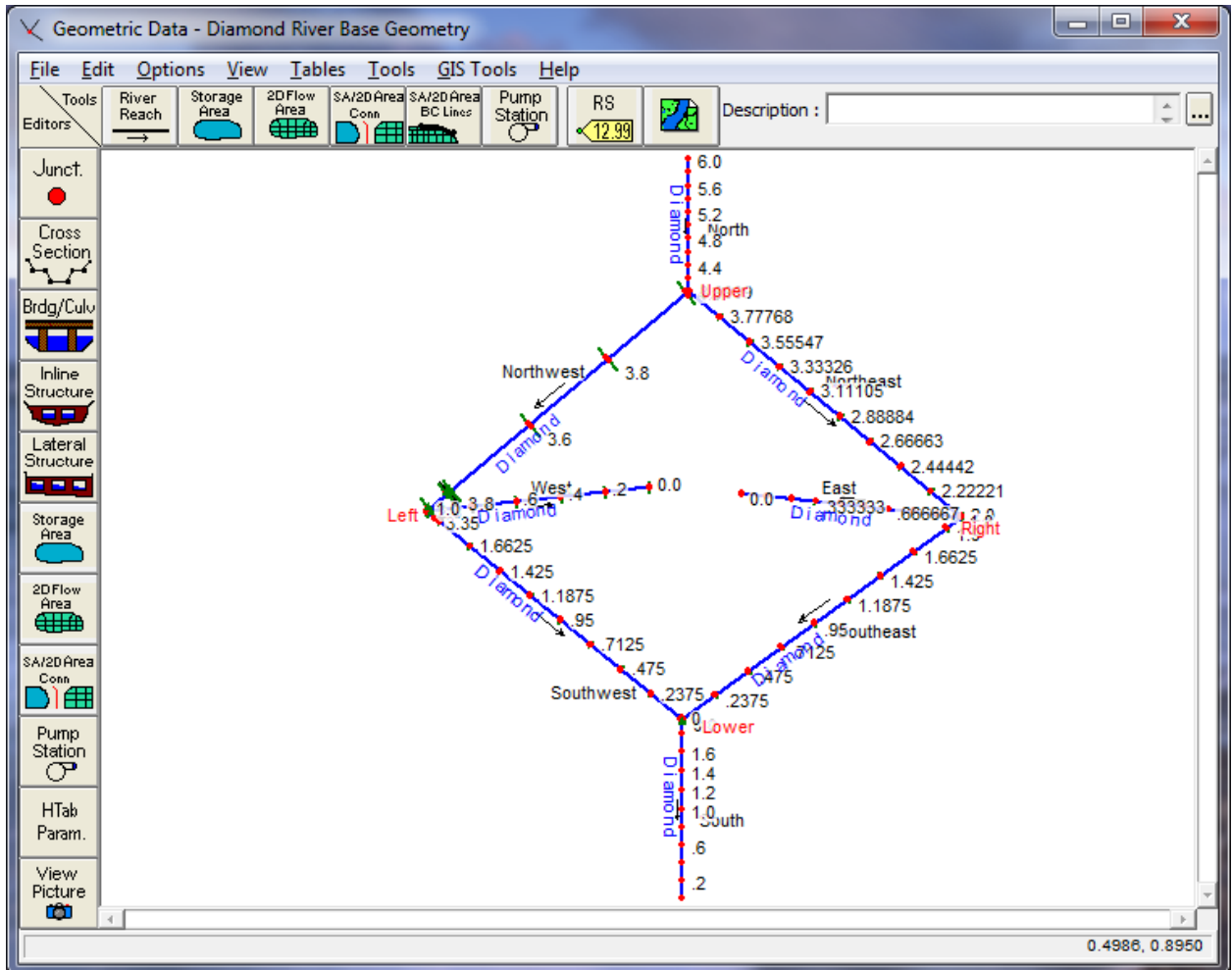

Figure 17-2: Initial Geometry for Development

### Creating Storage Areas

In the **Geometric Data Editor**, the starting geometry for this example is shown in Figure 17.2. On the **Tools** toolbar in the **Geometric Data Editor** the icon for **Storage area** was selected. The pointer was then placed between the East and West reaches and the storage area was drawn by single clicking and dragging the mouse for each desired point for the storage area. The final point for the storage area was selected by double clicking the mouse. Upon double clicking the mouse, a dialog box appears requesting a

storage area name. The name "Pyramid Lake" was entered. Points on a storage area may be added or removed by using the Add Points to a Reach or SA and Remove Points to a Reach or SA options found in the Edit menu.

It is important that the program recognizes the connection of Pyramid Lake to the East and West reaches. The connection may be made in two different ways. The first option is to draw the storage area so the end of each reach is included within the storage area polygon. The second option is to drag and drop the end of each reach within the storage area polygon by using the **Move Object** tool found in the **Edit** menu of the **Geometric Data Editor**. In both cases the reach and storage area are connected if a black dot appears at the intersection of the reach and the side of the storage area.

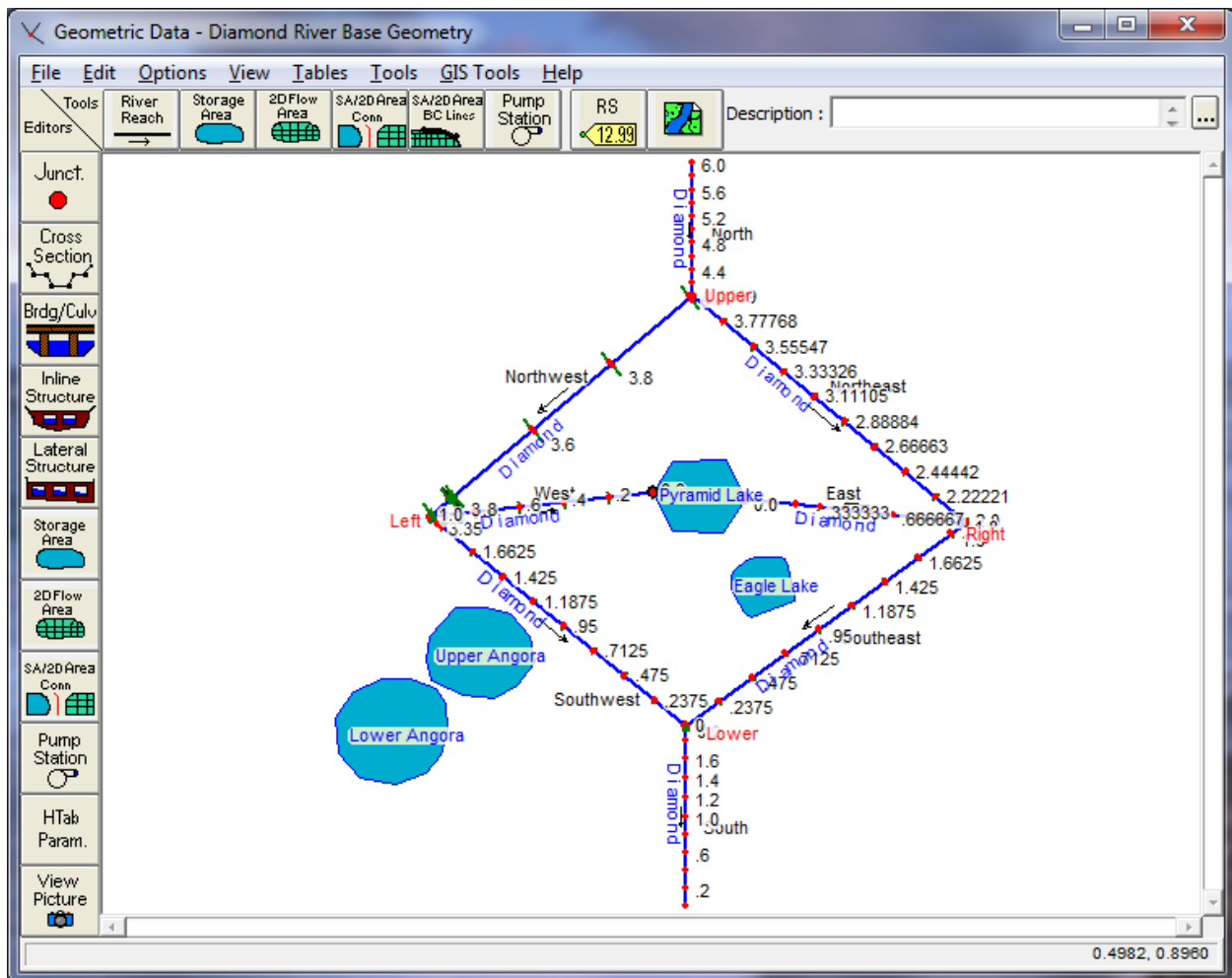

Figure 17-3: Geometry with Storage Areas

The remaining three storage areas were created in the same manner as Pyramid Lake without any connections to reaches. Figure 17.3 displays the completed storage areas in the **Geometric Data Editor** before the addition



of the hydraulic connections. The hydraulic connections for each storage area are discussed in impending sections.

### **Entering Data for a Storage Area**

After the storage area was drawn in the **Geometric Data Editor** the surface area for storage was entered. The data was entered in the **Storage Area Editor**, displayed in Figure 17.4, found by selecting the **Storage area** icon on the **Editors** toolbar. For Pyramid Lake the **Area times depth method** was selected. An area of 1000 acres with a minimum elevation of 0 feet was entered. This method computes the product of a constant area and change in water surface elevation to calculate storage volume.

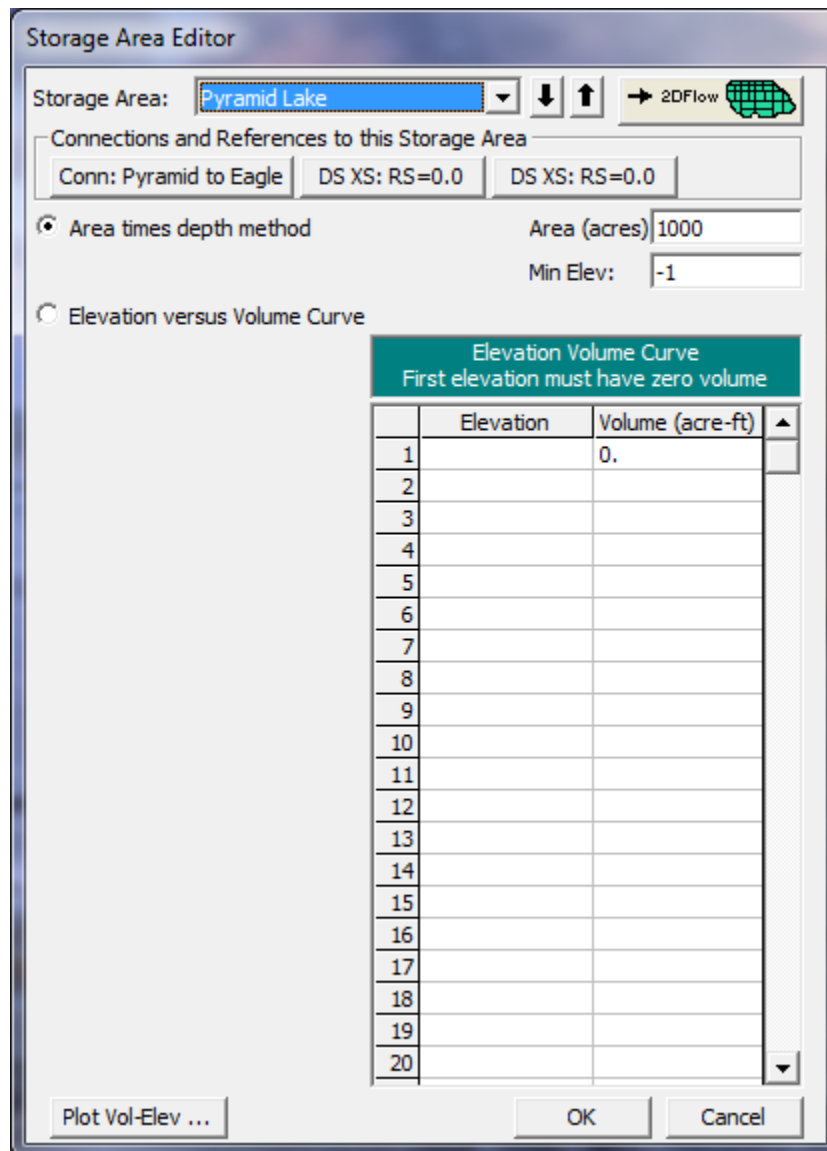

Figure 17-4: Storage Area Editor for Pyramid Lake

An additional option for calculating storage volume is the **Elevation versus volume curve** method, shown in Figure 17.5 for Eagle Lake. For this method the initial elevation was entered as 0 feet with a volume of 0 acre-feet. Data was then entered in increments of 2 feet for the cumulative volume of storage produced at each increment. It is important to note that the user is not entering the surface area of storage at each increment but the cumulative volume of storage at each increment.

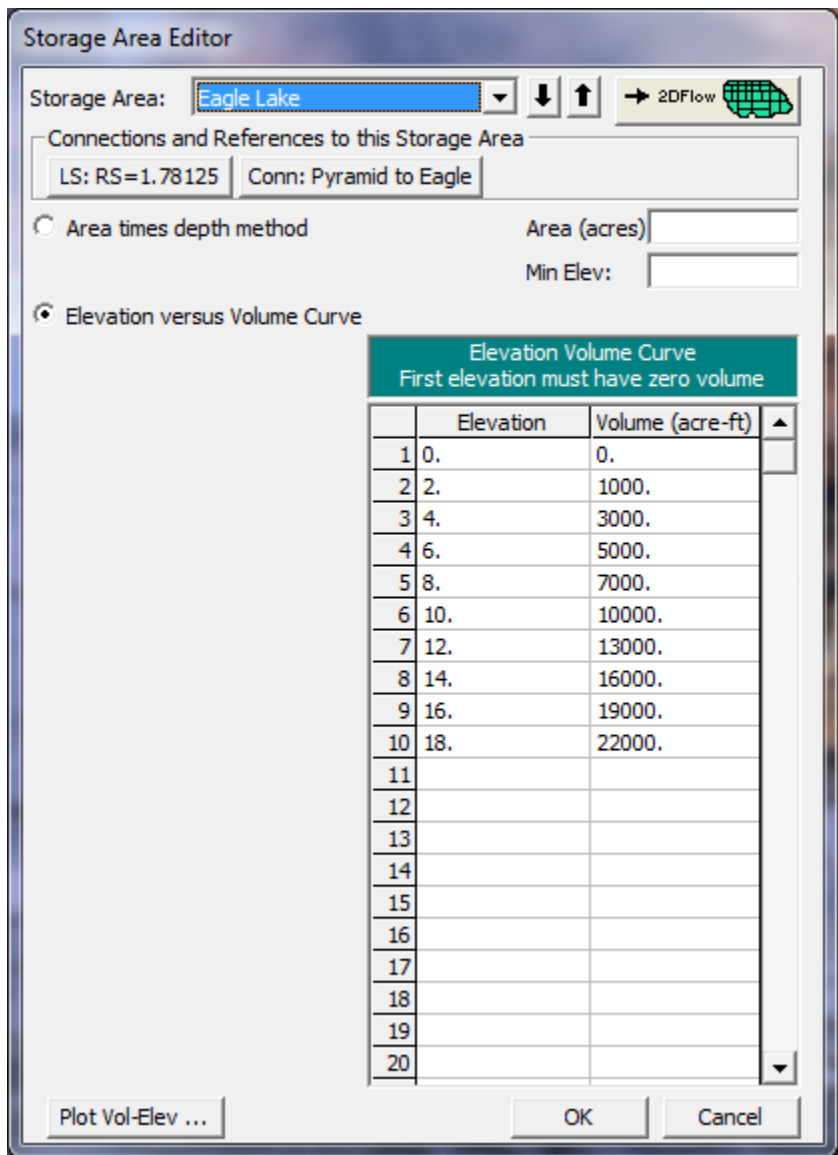

Figure 17-5: Storage Area Editor for Eagle Lake

### Lateral Structure Connected to a Storage Area

A lateral structure was placed on the Southwest Reach by selecting the **Lateral Structure** icon from the **Editors** toolbar in the **Geometric Data Editor**. After selecting the icon, the **Lateral Structure Data Editor** appears, as shown in Figure 17.6. With the reach selected as Southwest, under the **Options** menu, **Add a Lateral Structure** was selected. The location of the structure was entered at 1.95. This placed the beginning of the structure between river stations 1.99 and 1.9.

To enter data for the structure, the **Weir/Embankment** icon was selected from the **Lateral Structure Data Editor**. The data was entered as shown in Figure 17.7 on the **Lateral Weir Embankment Window**. The weir is broad crested with a width of 10 feet, placed 10 feet from the upstream river station 1.99. The weir flow reference method was chosen as "water surface."

Returning to the **Lateral Structure Data Editor**, the "right overbank" was selected from the pull-down position menu. Lastly, a connection was made to the storage area by selecting the **Set SA** button. A window will then popup, allowing the user to select a storage area to connect to. On the pull-down menu "Upper Angora" was selected.

Another lateral structure was added from the southeast reach to the Eagle lake storage area. This lateral structure was added in the same manner as the previous one, except it had a culvert in addition to the overflow weir.

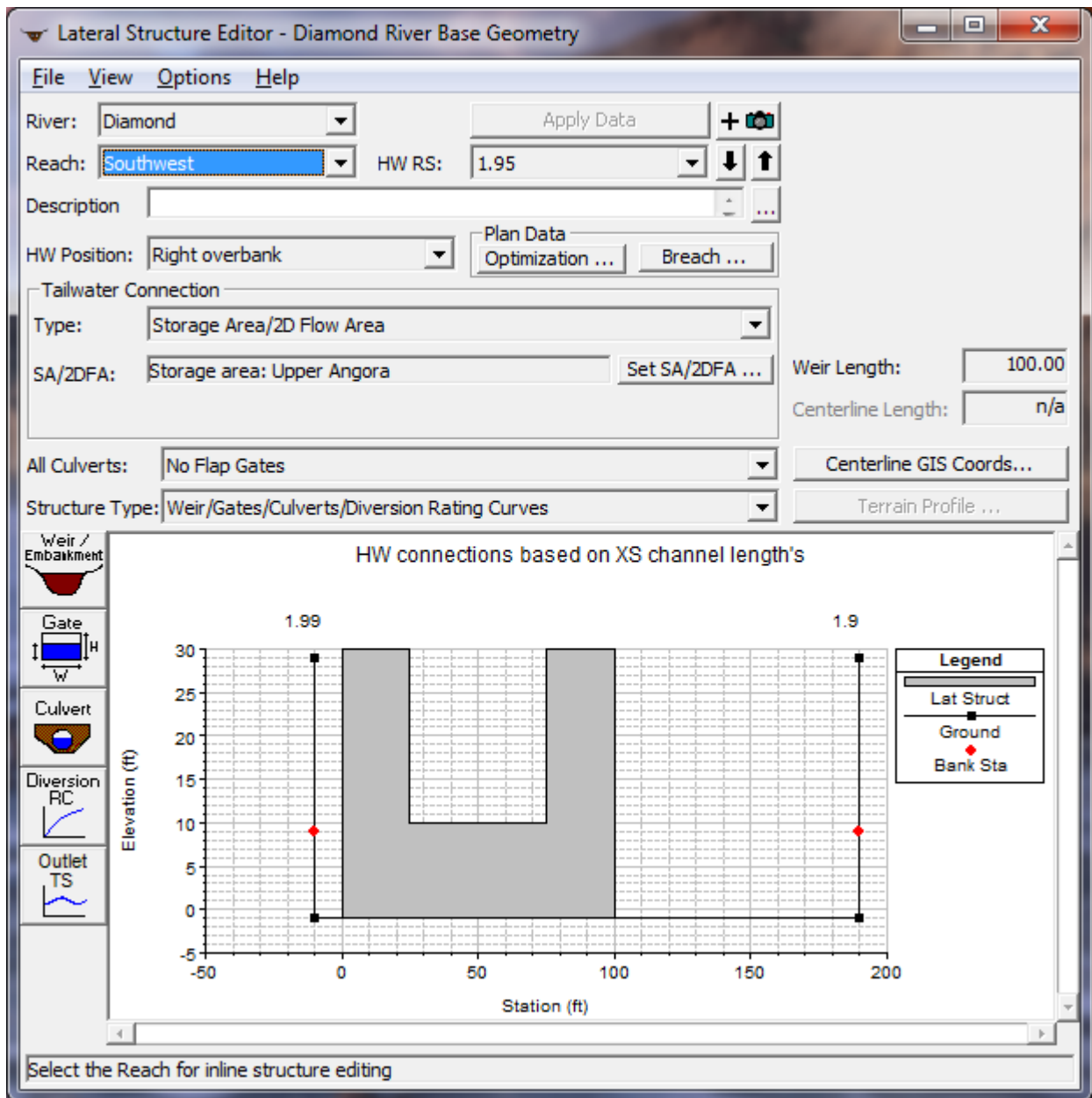

Figure 17-6: Lateral Weir Data Editor

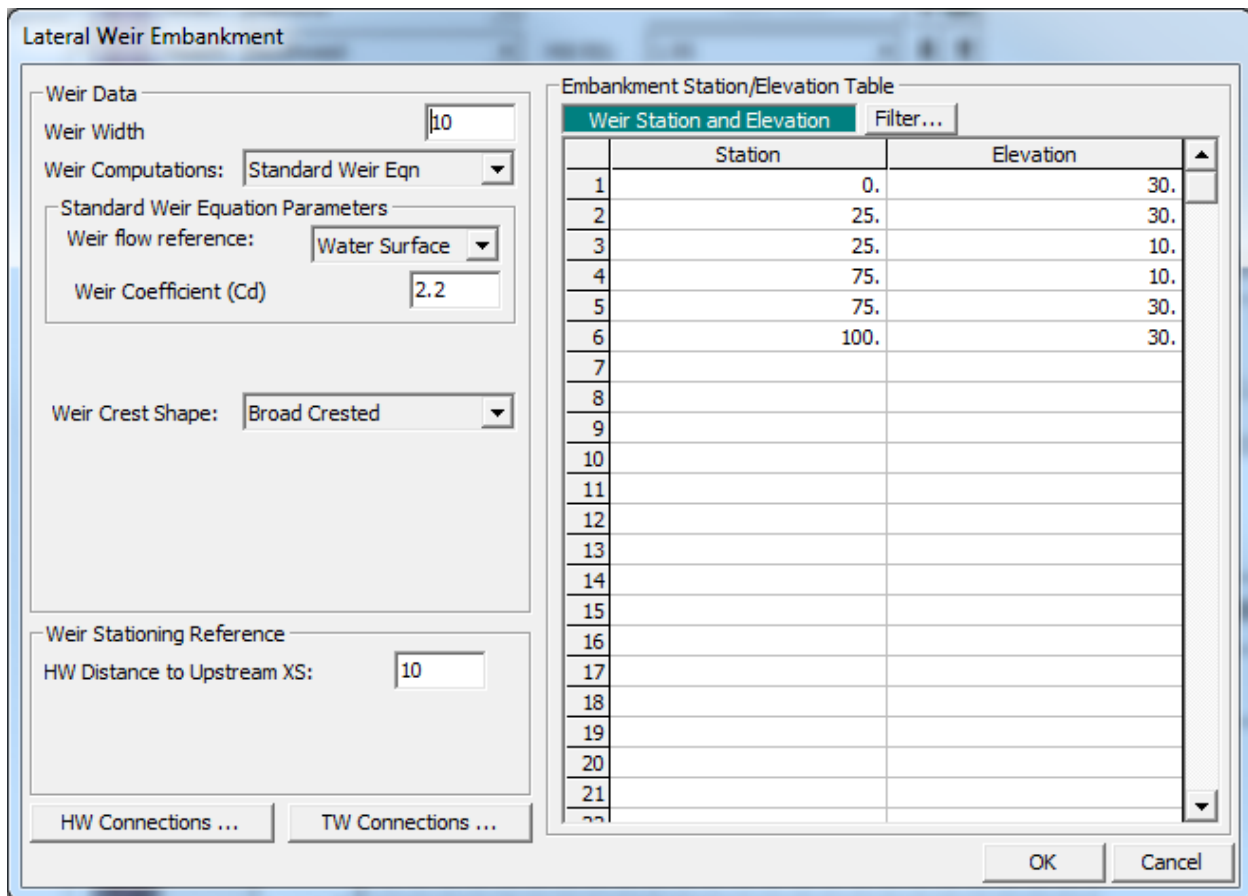

Figure 17-7: Lateral Weir Embankment Window

### Storage Area Connections

Storage area connections are used to connect storage areas to other storage areas. To make a connection from Pyramid Lake to Eagle Lake, the **SA/2D Area Conn** icon was selected from the **Editors** toolbar in the **Geometric Data Editor**. This brought up the **SA/2D Connection Data** editor shown in Figure 17.8. The storage areas were selected by pressing the **Set SA/2D** buttons next to the **From** and **To** location fields. Pyramid Lake was selected as the **From** location, and Eagle lake as the **To** location. Next the **Weir/Embankment** icon was selected. A 500 ft long broad crested weir was entered at an elevation of 16.5 feet.

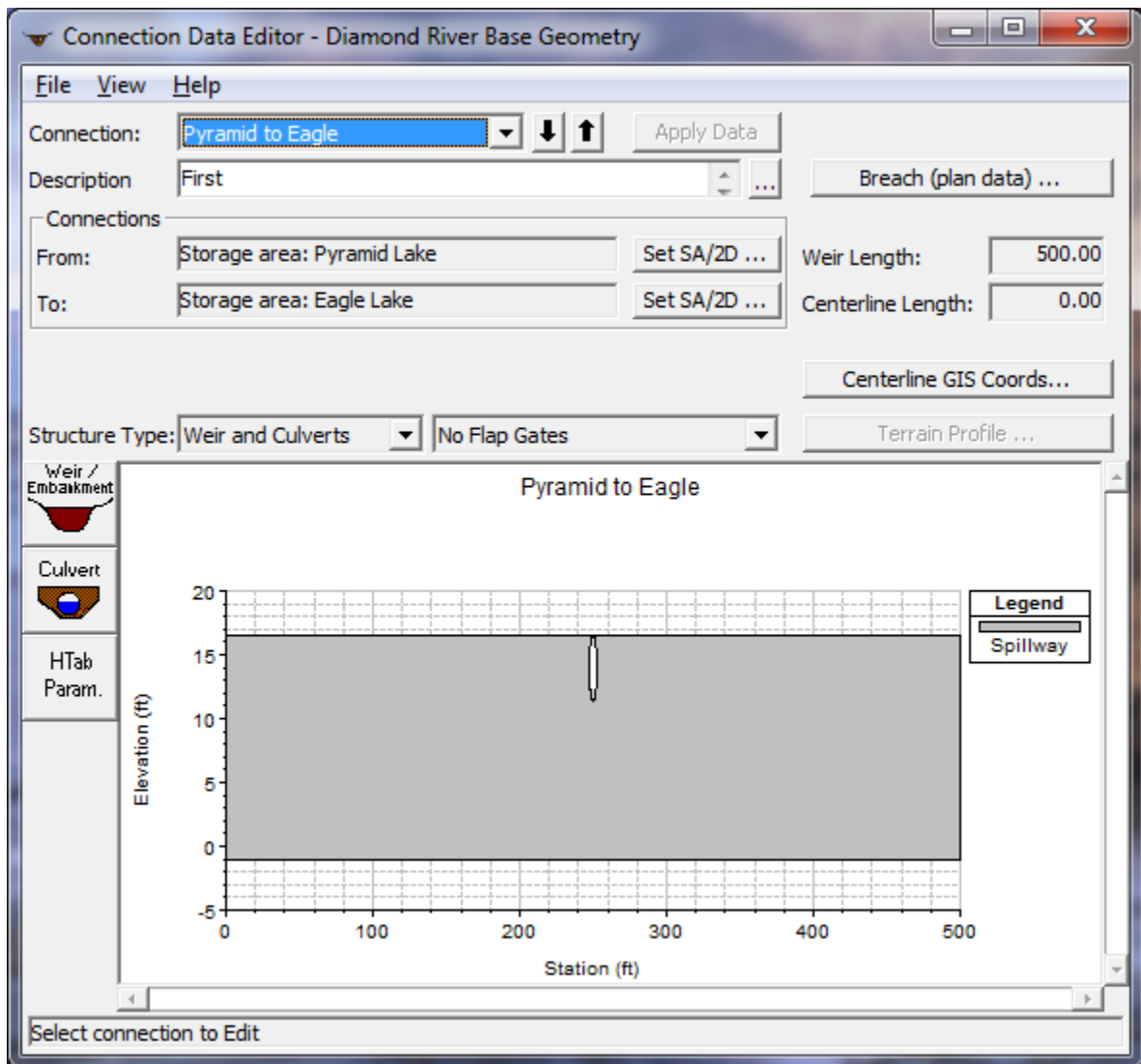

Figure 17-8: Storage Area Connection Editor for Pyramid to Eagle Lakes

An opening in the embankment was placed along the centerline of the weir by selecting the **Culvert** icon on the **Storage Area Connection Data Editor**. This selection displayed the **Culvert Data Editor** shown on Figure 17.9. A circular culvert with a diameter of 5 feet and an invert elevation of 11.5 feet was entered for this hydraulic connection. Additional parameters entered are shown in Figure 17.9.

One additional storage area connection (Upper to Lower lake) was constructed in the same manner to connect those two storage areas.

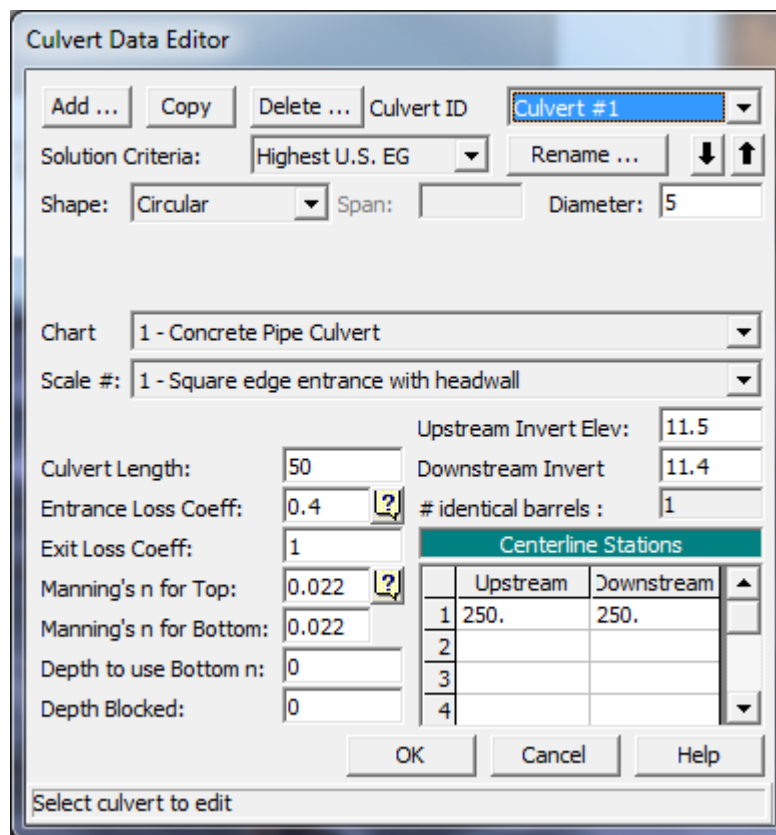

Figure 17-9: Culver Data Editor for RS 1.9 to Eagle

### Parameters for Hydraulic Tables

Hydraulic structures, such as bridges and culverts, are converted into families of rating curves that describe the structure as a function of tailwater, flow, and headwater. The user can set parameters to define the curves by selecting **HTab Parameters** from the **Bridge and Culvert Editor** or from the **Storage Area Connection Editor**. For this example, the culverts in storage area connections, the culvert located on the Northwest Reach, and the bridge located on the South Reach may have their parameters adjusted.

For the bridge located on the South Reach the **Bridge/Culvert** icon on the **Editor** toolbar in the **Geometric Data Editor** was selected. In the **Bridge Culvert Data** the South Reach was selected and the **HTab Param** icon was depressed bringing up the **Parameters for Hydraulic Properties Tables** shown in Figure 17.10. Default values were used for the number of points on a free flow curve, the number of submerged curves, and the number of points on each submerged curve. Limits on the extent of the curves were defined by setting the maximum headwater and tailwater elevations at 19 feet. For additional information on HTab Parameters refer to Chapter 8 of the User's Manual, Performing an Unsteady Flow Analysis.



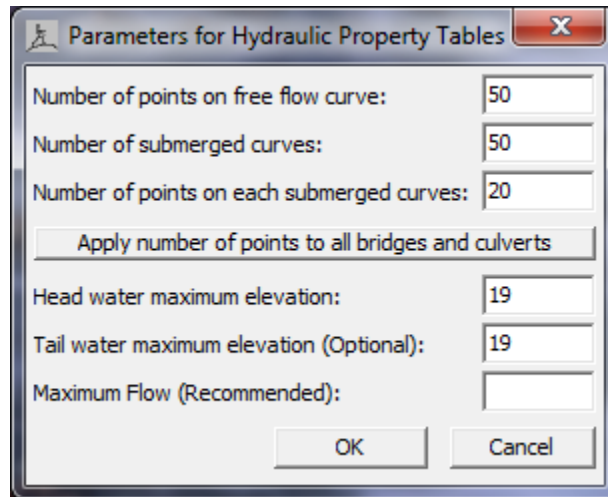

Figure 17-10: Parameter for Hydraulic Property Tables

## Cross Section Table Parameters

In HEC-RAS, cross sections are processed into tables of elevation versus hydraulic properties of areas, conveyances, and storage. The user is required to set an interval for spacing the points in the cross-section tables. In the **Geometric Data Editor** the icon **Htab Parameters** was selected under the **Editors** toolbar. This displays the **Cross Section Table Parameters Window** shown in Figure 17.11. The starting elevation, table increment, and number of points columns are automatically filled by the program but may be changed by the user. The program automatically starts the table for each cross section 1 foot above the channel invert. The program chooses a table increment and number of points by first attempting to use 20 points, and choosing an increment that will put the table up to the top of the cross section. If this results in too large of an increment (greater than 1.0 foot) the program will use a one foot increment and add additional points to get the table to the top of the cross section. The increment for this example was set to 1 for "All Reaches" by highlighting the increment column and selecting the **Set Values** button. The user can set individual values for each cross section if it is deemed necessary. **Warning: Always ensure that your cross section tables encompass the complete range of stages that will be modeled.** If the tables do not go up to a high enough elevation, the program will have to extrapolate during the computations. More often than not, the extrapolation causes instabilities in the results. To visualize the extent of the tables, a graphic of individual cross sections is shown on the right hand side of the window. The graphic displays the cross section corresponding to the row in which you cursor lies in the table.

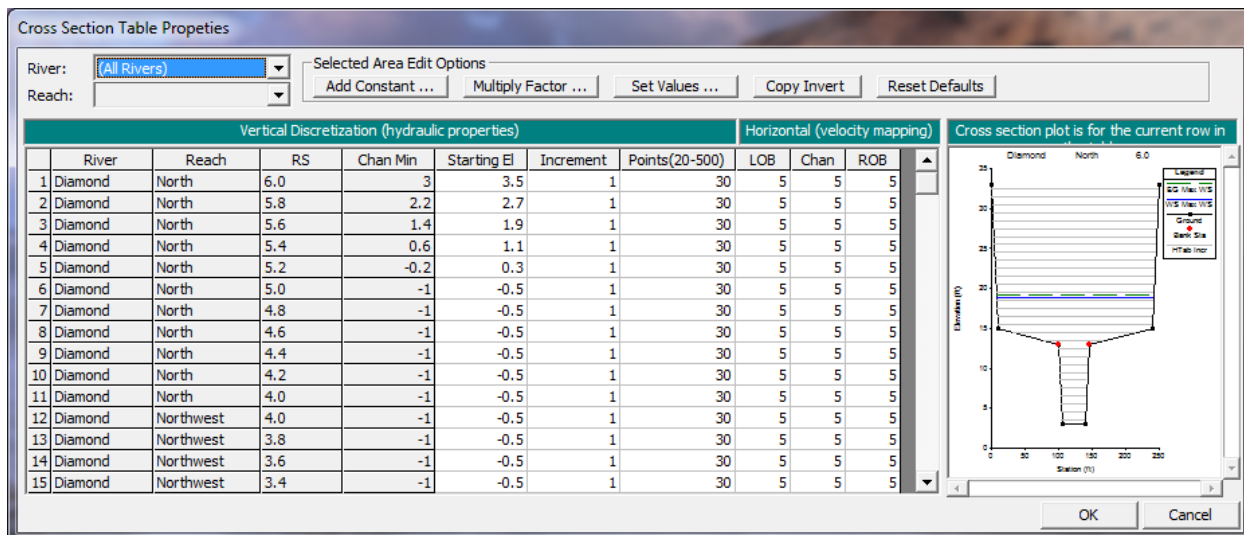

Figure 17-11: Cross Section Table Parameters

## Unsteady Flow Data

The user is required to enter boundary conditions and initial conditions for the system at the beginning of the simulation period. For additional information on unsteady flow data refer to Chapter 8 of the User’s Manual, Performing an Unsteady Flow Analysis. The **Unsteady Flow Data Editor**, shown in Figure 17.12, was selected from the main program window under the **Edit** menu.

### Boundary Conditions

Boundary conditions are required for the farthest upstream and downstream cross sections. Upon entering the **Unsteady Flow Data Editor** the farthest upstream and downstream cross sections will be located in the boundary conditions column. In this case, the user will see River Station 6.0 on the North Reach and River Station 0.0 on the South Reach. Boundary conditions are set by highlighting the adjacent cell under **Boundary Condition Type**. When a cell is highlighted, not all boundary conditions are available. The program will automatically gray out all irrelevant boundary condition types. Internal boundary conditions may be added by selecting one of the buttons under the “Add Boundary Condition Location” heading.

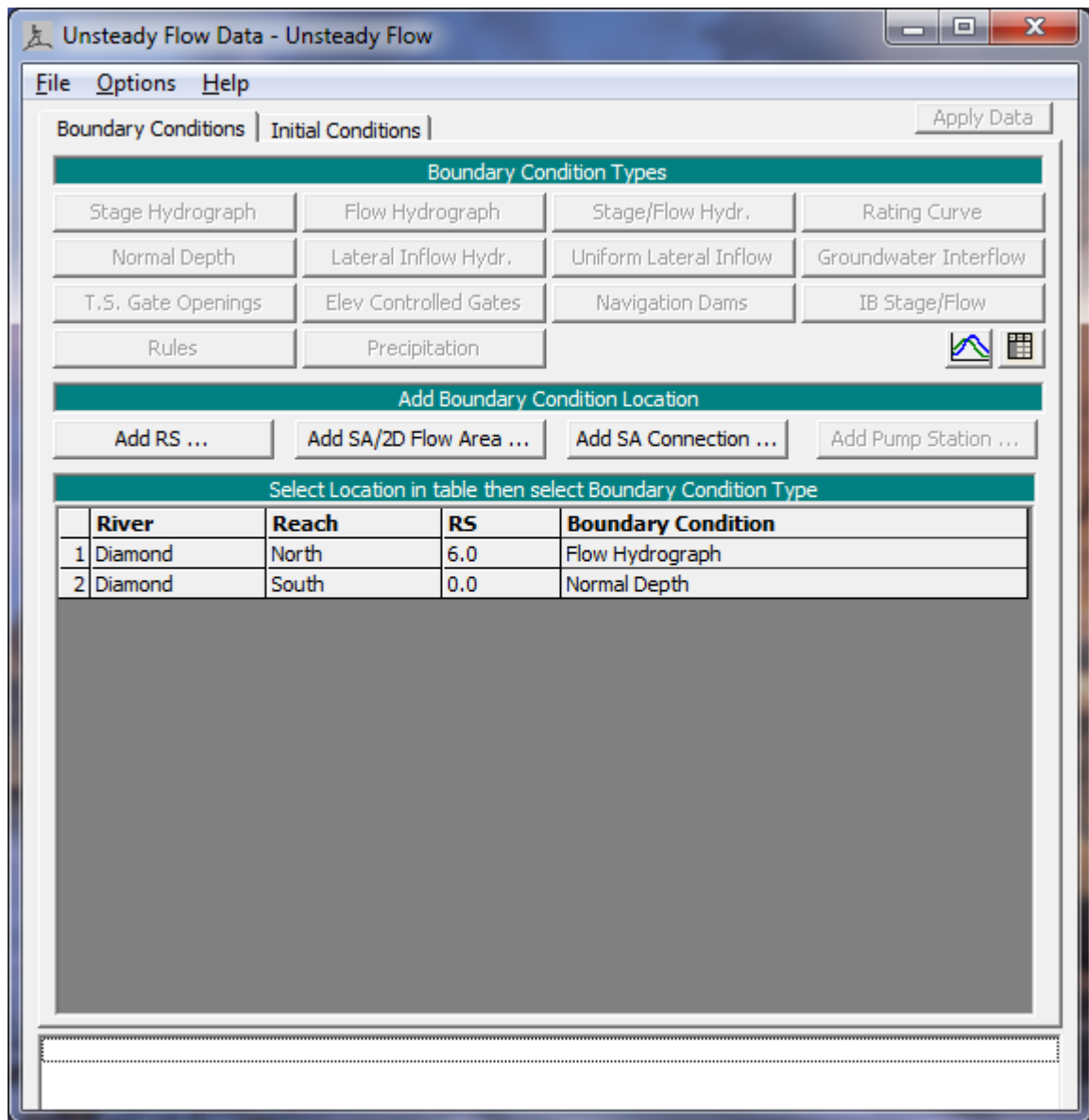

Figure 17-12: Unsteady Flow Data Editor

### Upstream Boundary Condition

For River Station 6.0 a flow hydrograph was selected by highlighting the cell and pressing the **Flow Hydrograph** button. The window for a **Flow Hydrograph** is shown in Figure 17.13. For this example the flow hydrograph was manually entered by selecting the **Enter Table** radio button. The **Data Time Interval** was set to three hours and the radio button **Use Simulation Time** was selected. The **Use Simulation Time** option starts the hydrograph at the beginning of the simulation time window, which is discussed in an

upcoming section. The hydrograph was then manually entered with a baseflow of 100 cfs and a floodwave that peaked at 5000 cfs.

**Flow Hydrograph**

River: Diamond Reach: North RS: 6.0

Read from DSS before simulation Select DSS file and Path

File:

Path:

Enter Table Data time interval: 3 Hour

Select/Enter the Data's Starting Time Reference

Use Simulation Time: Date: 01JAN1990 Time: 0800

Fixed Start Time: Date:  Time:

No. Ordinates    Interpolate Missing Values    Del Row    Ins Row

Hydrograph Data			
	Date	Simulation Time (hours)	Flow (cfs)
1	01Jan1990 0800	00:00	100.
2	01Jan1990 1100	03:00	100.
3	01Jan1990 1400	06:00	100.
4	01Jan1990 1700	09:00	100.
5	01Jan1990 2000	12:00	100.
6	01Jan1990 2300	15:00	100.
7	02Jan1990 0200	18:00	100.
8	02Jan1990 0500	21:00	100.
9	02Jan1990 0800	24:00	100.
10	02Jan1990 1100	27:00	325.
11	02Jan1990 1400	30:00	550.
12	02Jan1990 1700	33:00	775.
13	02Jan1990 2000	36:00	1000.

Time Step Adjustment Options ("Critical" boundary conditions)

Monitor this hydrograph for adjustments to computational time step

Max Change in Flow (without changing time step):

Min Flow:  Multiplier:

Plot Data    OK    Cancel

Figure 17-13: Flow Hydrograph for Upstream Boundary Condition

The user may also select to read hydrograph data from a DSS file. To do this the user presses the button **Select DSS file** and Path. When this button is pressed a DSS file and pathname selection screen will appear as shown in Figure 17.14. The user first selects the desired DSS file by using the browser button at the top. Once a DSS file is selected, a list of all of the DSS

pathnames within that file will be displayed in the table. The user can use the pathname filters to reduce the number of pathnames shown in the table. When the desired DSS pathname is found the user closes the window and the filename and pathname will be recorded in the **Flow Hydrograph Window**.

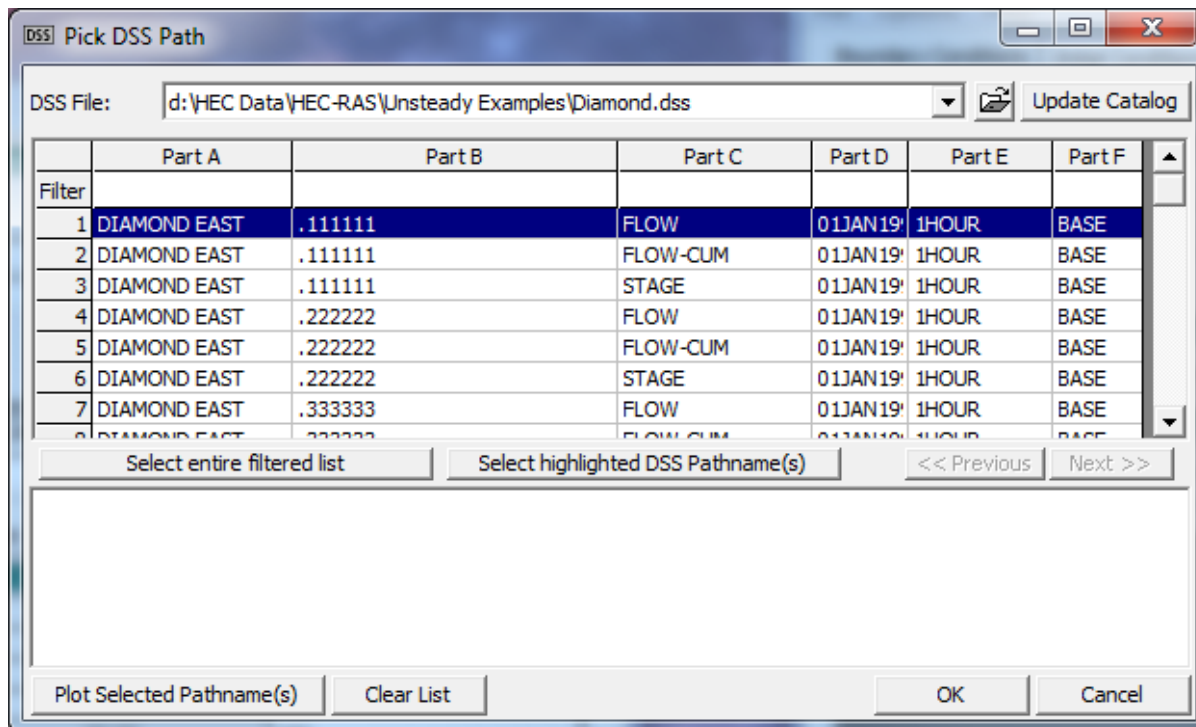

Figure 17-14: DSS Pathname and Filename

### Downstream Boundary Condition

For River Station 0.0 of the South Reach the boundary condition selected was normal depth. Again, the corresponding cell for that particular river station was highlighted and the **Normal Depth** button was selected. The window shown in Figure 17.15 is then displayed and a value of 0.0000947 was entered. This method requires the user to enter a friction slope for the reach in the vicinity of the boundary condition, the slope of the water surface is often a good estimate of the friction slope.

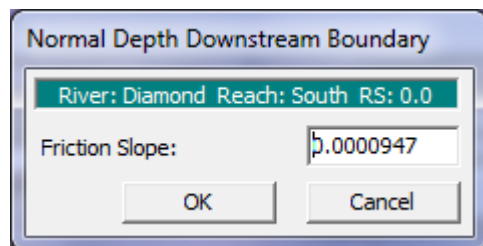

Figure 17-15: Normal Depth for Downstream Boundary

## Initial Conditions

Initial conditions consist of flow and stage information at each of the cross sections, as well as elevations for any storage areas defined in the system. Data for initial conditions is established by selecting the **Initial Conditions** tab on the **Unsteady Flow Data Editor**. After selecting the tab, Figure 17.16 will be displayed.

Unsteady Flow Data - Unsteady Flow

File Options Help

Boundary Conditions Initial Conditions Apply Data

Initial Flow Distribution Method

Use a Restart File Filename:

Enter Initial flow distribution (Optional - leave blank to use boundary conditions)

Add RS...

User specified fixed flows (Optional)

	River	Reach	RS	Initial Flow
1	Diamond	North	6.0	100
2	Diamond	Northwest	4.0	70
3	Diamond	Northeast	3.9999	30
4	Diamond	Southeast	2.0	20
5	Diamond	Southwest	2.0	60
6	Diamond	South	2.0	80
7	Diamond	West	1.0	10
8	Diamond	East	1.0	10

Initial Elevation of Storage Areas/2D Flow Areas (Optional) Import Min SA Elevation(s)

Keep initial elevations constant during warmup

	Storage Area/2D Flow Area	Initial Elevation
1	Eagle Lake	10
2	Lower Angora	12
3	Pyramid Lake	11
4	Upper Angora	10

Figure 17-16: Unsteady Flow Data Initial Conditions

Flow data was entered for each reach so the program could perform a steady-flow backwater run to compute the corresponding stages at each cross section. As shown on Figure 17.16, the North Reach has an initial flow of 100 cfs, corresponding to the baseflow of the hydrograph entered as the upstream boundary condition. The other various reaches then split the 100 cfs of flow down to the South Reach where the flow combines to 80 cfs. In addition to flow data, initial elevation for each storage area is needed. Initial elevations were set to 11, 10, 12, and 10 feet for Pyramid Lake, Eagle Lake, Lower Angora, and Upper Angora, respectively. The data was then saved in the **Unsteady Flow Data Editor** and the window was closed.

## Unsteady Flow Analysis

After the geometry and unsteady flow data have been completed an unsteady flow analysis may be initiated. Under the main program window **Unsteady Flow Analysis** was selected under the **Run** menu. This will display the **Unsteady Flow Analysis Window** shown in Figure 17.17. A plan was defined by selecting the Geometry File "Diamond River Base Geometry" and the Unsteady Flow File "Unsteady Flow." Under the **File** menu, **Save Plan As** was selected and the plan title was entered as "Diamond River Base Plan." After entering the title of the plan a short identifier was entered as "Base" and the plan was saved.

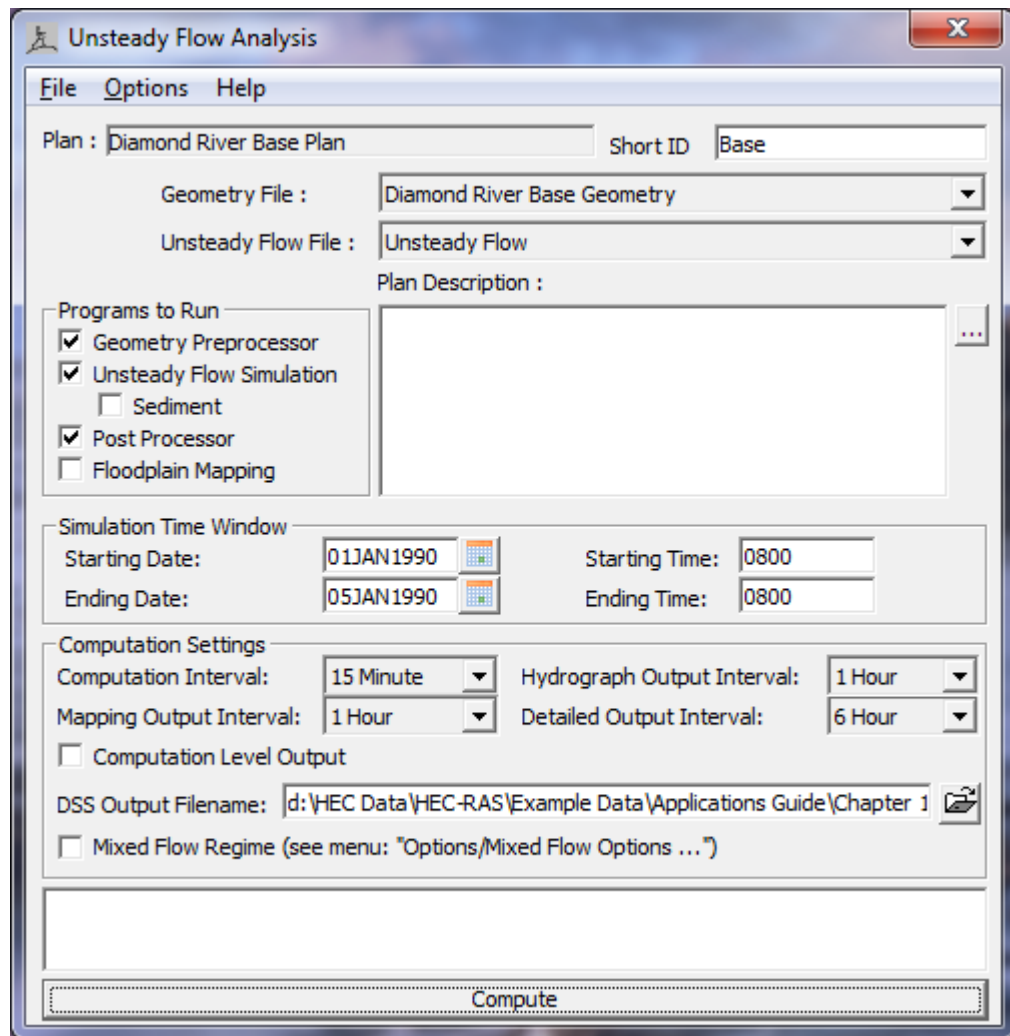

Figure 17-17: Unsteady Flow Analysis Window

## Simulation Time Window

The simulation time window, located on Figure 17.17, requires a beginning and ending date and time for simulation. The date must have a four digit year and can be entered in either of the two following formats: 01Jan1990 or 01/01/1990. For this application the date was saved in the first format. The time field is entered in military time (i.e. 1 p.m. is entered as 1300). For this application the simulation time began and ended at 0800.



## Computation Settings

The computation settings in the **Unsteady Flow Analysis Window** contain the following: the computational interval; hydrograph output interval; instantaneous profiles interval; and the name and path of the output DSS file.

For this example the computation interval was set to 15 minutes. The computation interval should be small enough to accurately describe the rise and fall of the floodwave. The hydrograph output interval was set to 1 hour. This interval defines the output of computed stage and flow hydrographs written to HEC-DSS. The detailed output interval was set to 6 hours, specifying the interval at which detailed hydraulic output will be computed by the post processor. It is suggested that this interval remain fairly large to reduce the amount of post processing and storage required. The path selected for the output to DSS was "C:\HEC\RAS\Unsteady\Diamond.dss."

## Location of Stage and Flow Hydrographs

The user has the option of specifying locations to have hydrographs computed and available for display. The user may select individual cross sections, groups of cross sections, or entire reaches. From the **Options** menu on the **Unsteady Flow Analysis Window**, the **Stage and Flow Output Locations** option was selected, displaying Figure 17.18. For this example "All Reaches" was selected. This option will compute hydrographs at every cross section in the data set. If the user is working with an extremely large data set, computation time and data storage can be reduced by only selecting the most essential cross sections for output.

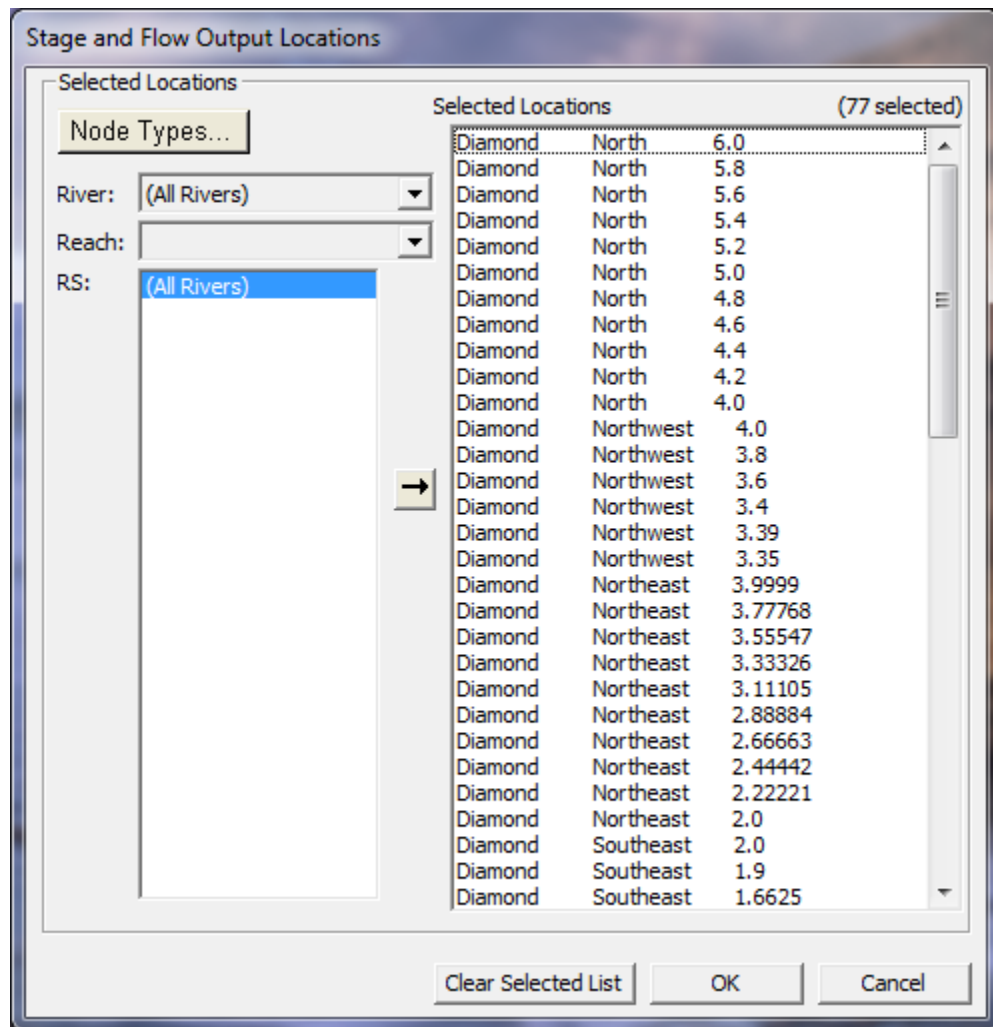

Figure 17-18: Stage and Flow Output Locations

## Unsteady Flow Simulation

There are three components used in performing an unsteady flow analysis within HEC-RAS: the geometric data preprocessor (HTAB); the unsteady flow simulator (UNET); and an output post processor.

### Geometry Pre-processor (HTAB)

The geometry pre-processor is used to speed up the unsteady flow calculations by processing the geometric data into a series of hydraulic property tables and rating curves. It is highly recommended and illustrated in this example that the user run the geometry pre-processor and examine

hydraulic output for anomalies before running the unsteady flow simulator and the post-processor.

The **Geometry Pre-processor** box under “Programs to Run” was selected in the **Unsteady Flow Analysis Window**, Figure 17.17. The **Unsteady Flow Simulation** and **Post-Processor** boxes were unselected (no checkmarks) and the Compute button was depressed. After the geometry pre-processor finished processing the data, **Hydraulic Property Plots** was selected from the **View** menu on the main program menu. Figure 17.19 displays a typical cross section plot of hydraulic properties for this example. Cross sections are processed into tables of elevations versus hydraulic properties of areas, conveyances, and storage. Viewing these plots for anomalies is a good diagnostic tool to search for cross sections with irregular geometry.

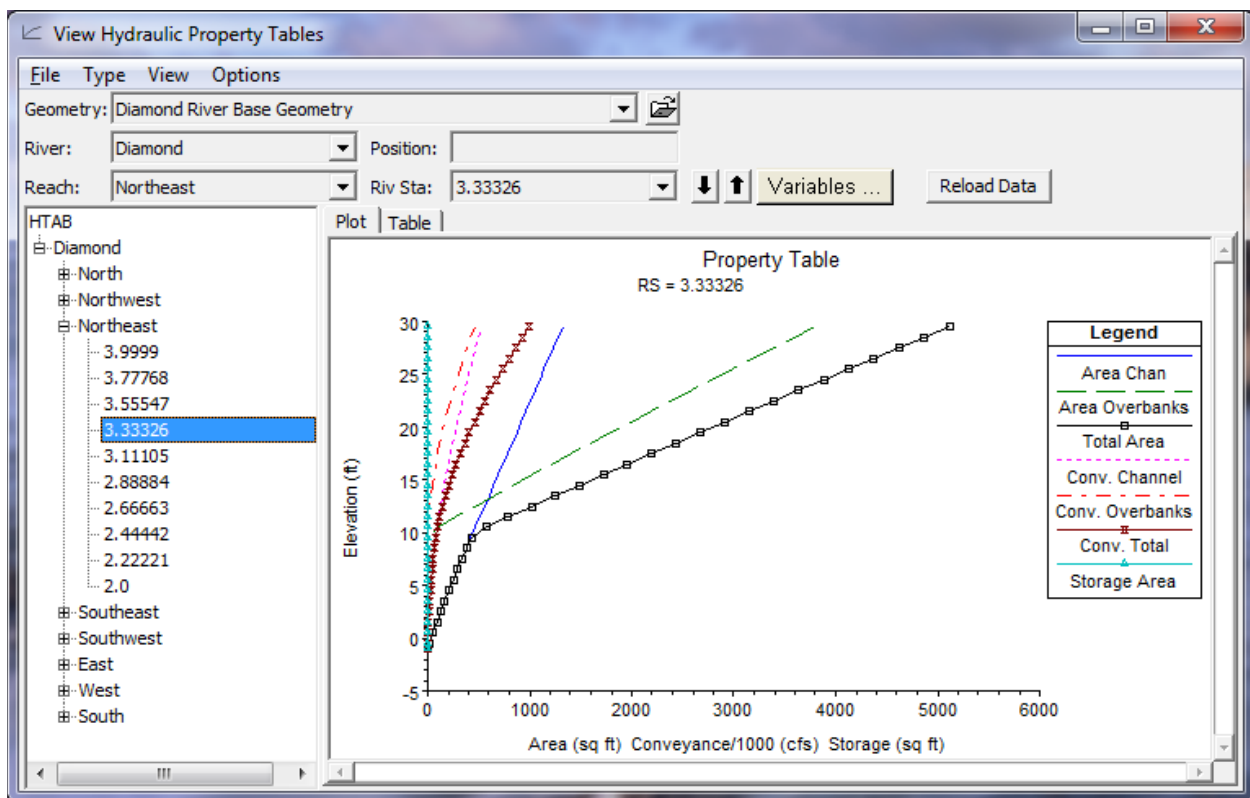

Figure 17-19: Hydraulic Properties for a Cross Section

The geometry pre-processor evaluates hydraulic structures such as bridges and culverts and relates the structures as a function of tailwater, flow, and headwater. From the **Type** menu in the **Hydraulic Properties Tables**, **Internal Boundaries** was selected. Next, the South Reach was selected displaying Figure 17.20, the family of rating curves for the bridge located at RS 1.895. On the plot the free flow rating function describes the flow if tailwater submergence does not occur, such as free flow over a weir. Above the free-flow rating function is a family of submerged flow rating curves, one for each tailwater elevation.

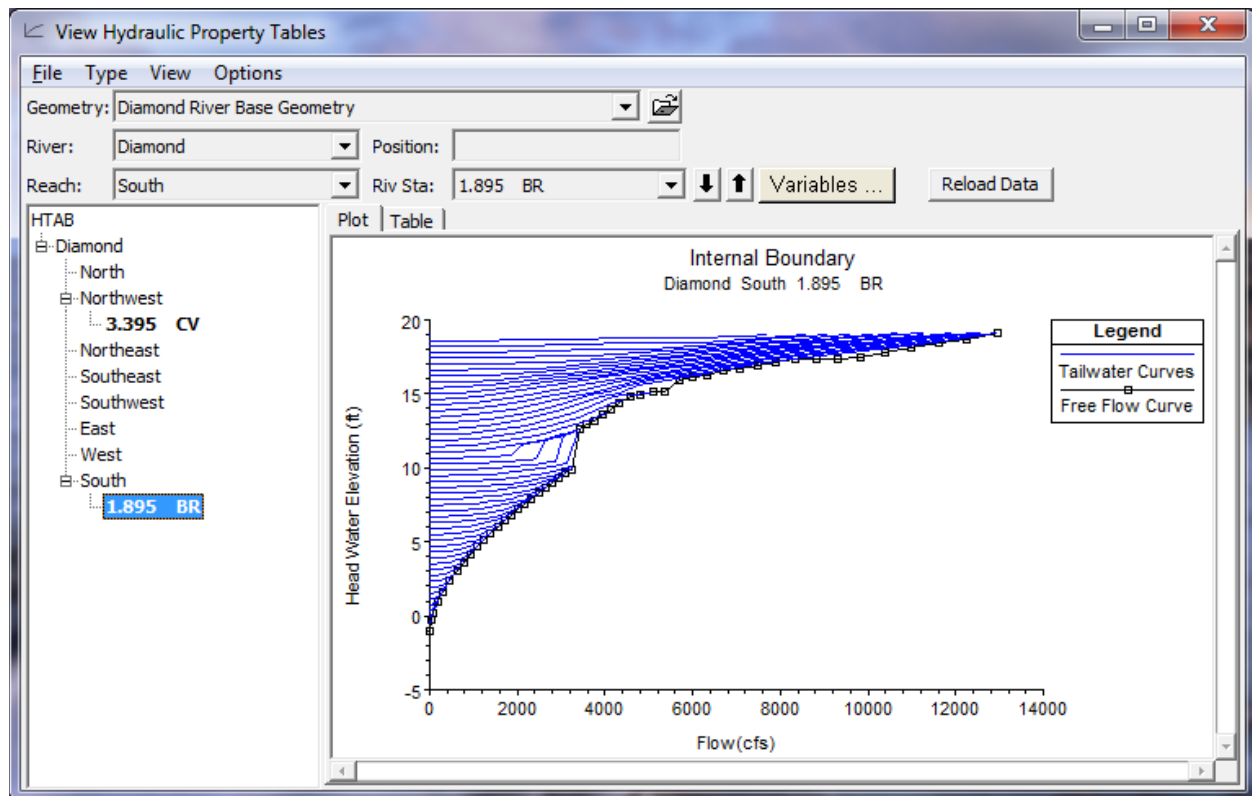

Figure 17-20: Family of Rating Curves for Bridge Located on the South Reach

As shown in Figure 17.20 there is a transitional area to left of the free flow curve between 10 and 12 feet of elevation where the lines of constant tailwater extend vertically. This occurs because at this water elevation flow begins to contact the upstream side of the bridge, causing backwater. This is a transition zone where free surface flow changes to orifice flow. This type of flow is unpredictable because the flow is changing from free surface flow to a “sluice gate type” of pressure flow and then possibly to a full flowing orifice flow.

## Unsteady Flow Simulation and the Post-Processor

After the hydraulic property tables were examined the **Geometry Pre-processor** box was unselected on the **Unsteady Flow Analysis Window** and the **Unsteady Flow Simulation** and **Post-Processor** boxes were selected. Then the **Compute** button was depressed.

The output from the simulation can be viewed from many different tables and graphs. The most interesting output for this example is found by viewing the stage and flow hydrographs. From the main program window, **View** and then **Stage and Flow Hydrograph** was selected. By selecting the **Type** menu on the **Stage and Flow Hydrograph Window** the user can view stage and flow

hydrographs for cross sections, bridges, culverts, inline structures, lateral structures, storage areas, storage area connections, and pump stations.

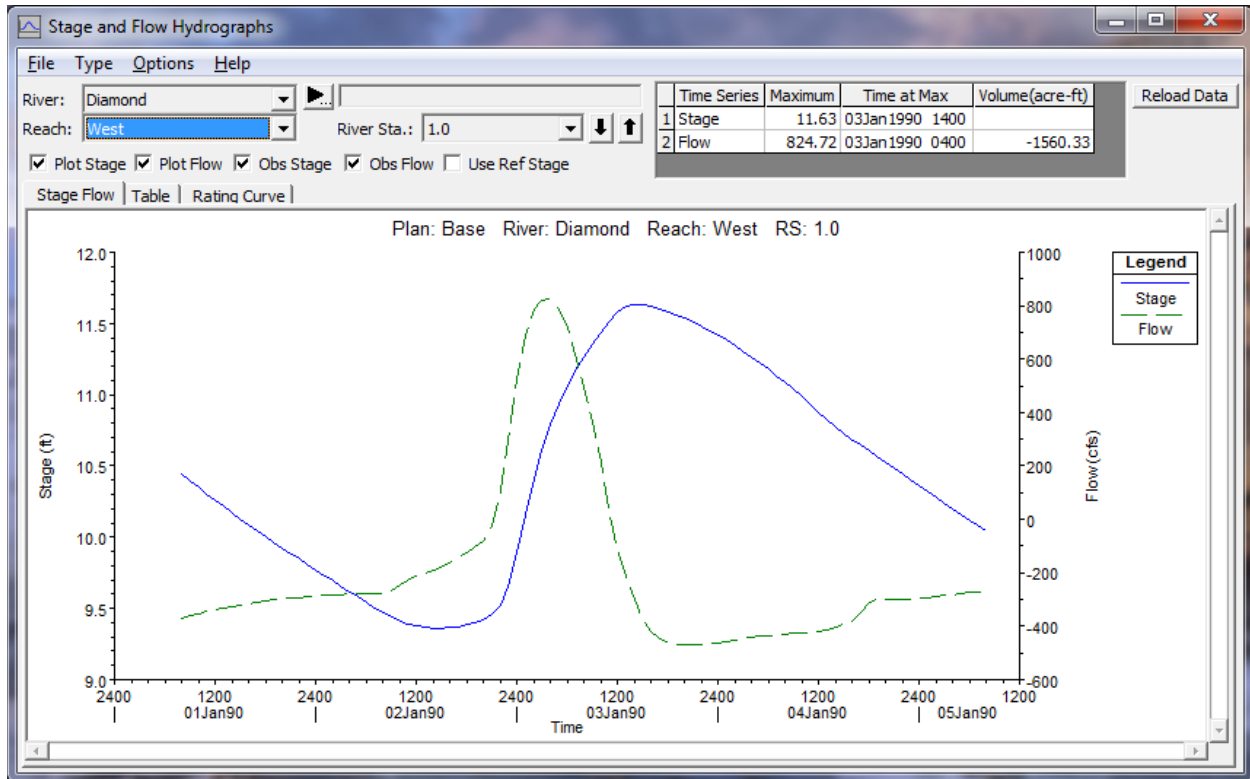

Figure 17-21: Stage and Flow Hydrograph for the West Reach

First, the “Cross Section” option was selected from the **Type** menu and the reach was set to West, displaying Figure 17.21. As seen from the figure, the flow was initially negative, denoting that at the beginning of the simulation time flow was moving away from Pyramid Lake. As the floodwave progressed the flow changed to positive, implying a reversal in the direction of flow towards Pyramid Lake. After the floodwave passed, the direction of flow returned to flowing away from Pyramid Lake. The stage and flow can also be viewed as tabular output by selecting the **Table** tab located on the **Stage and Flow Hydrograph Window**. The output will be displayed in the increment set on the hydrograph output interval located in the **Unsteady Flow Analysis Window**.

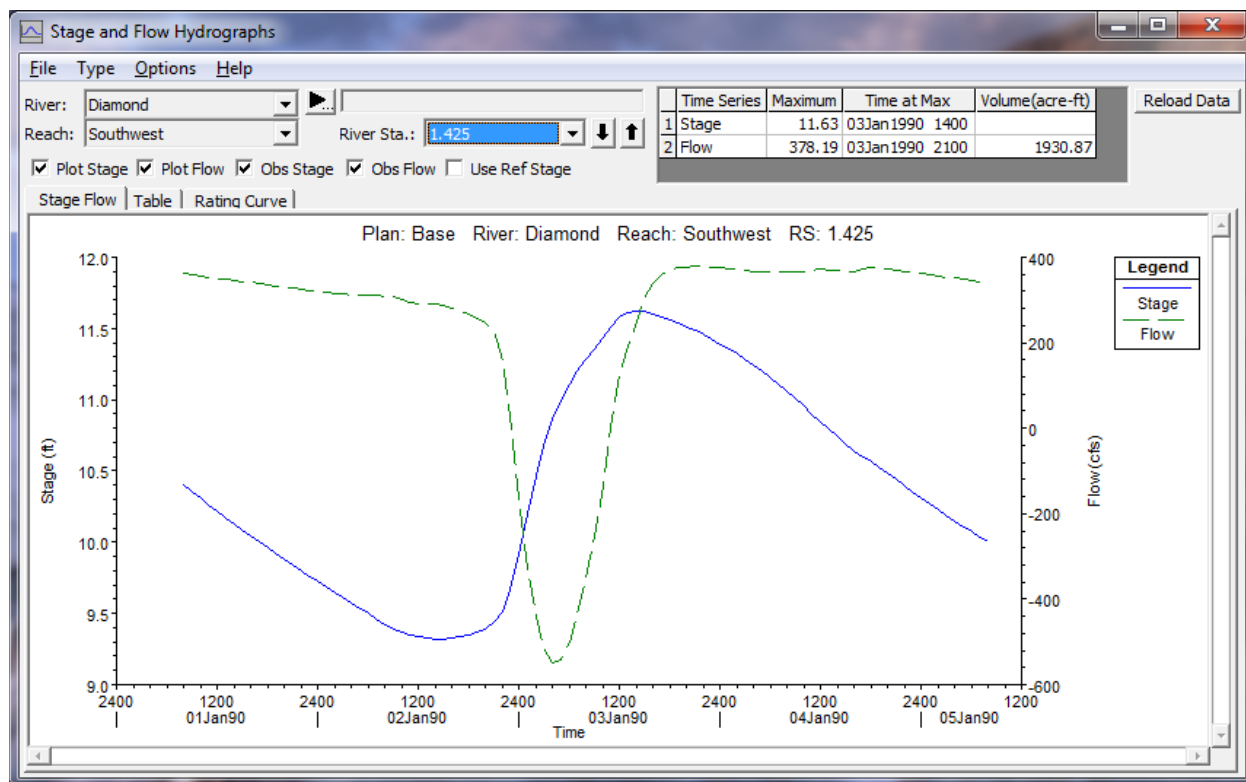

Figure 17-22: Stage and Flow Hydrograph for Southwest Reach

The geometric data set was constructed with relatively no slope to emphasize the ability of RAS to model unsteady flow, including flow reversals. As seen in Figure 17.22 for the Southwest Reach, the flow reverses direction during the peak of the floodwave. This flow reversal occurs because water is diverted to the West Reach and to the lateral weir on the Southwest Reach. These diversions decrease the flow in the Southwest Reach compared to the flow in the Southeast Reach. The discrepancy in flows between the two reaches causes a significant difference in water surface elevations at the Lower Junction. The difference in water surface elevation forces water to move upstream on the Southwest Reach during the floodwave.

Next, the **Lateral Structure** option was selected from the **Type** menu and the reach was set to Southwest, displaying Figure 17.23. As shown in Figure 17.23, the lateral weir is affected by the flow reversal on the Southwest Reach. Additionally, the tailwater stage for the lateral weir rises above the headwater stage twice during simulation, causing flow to enter the reach from the lateral weir.

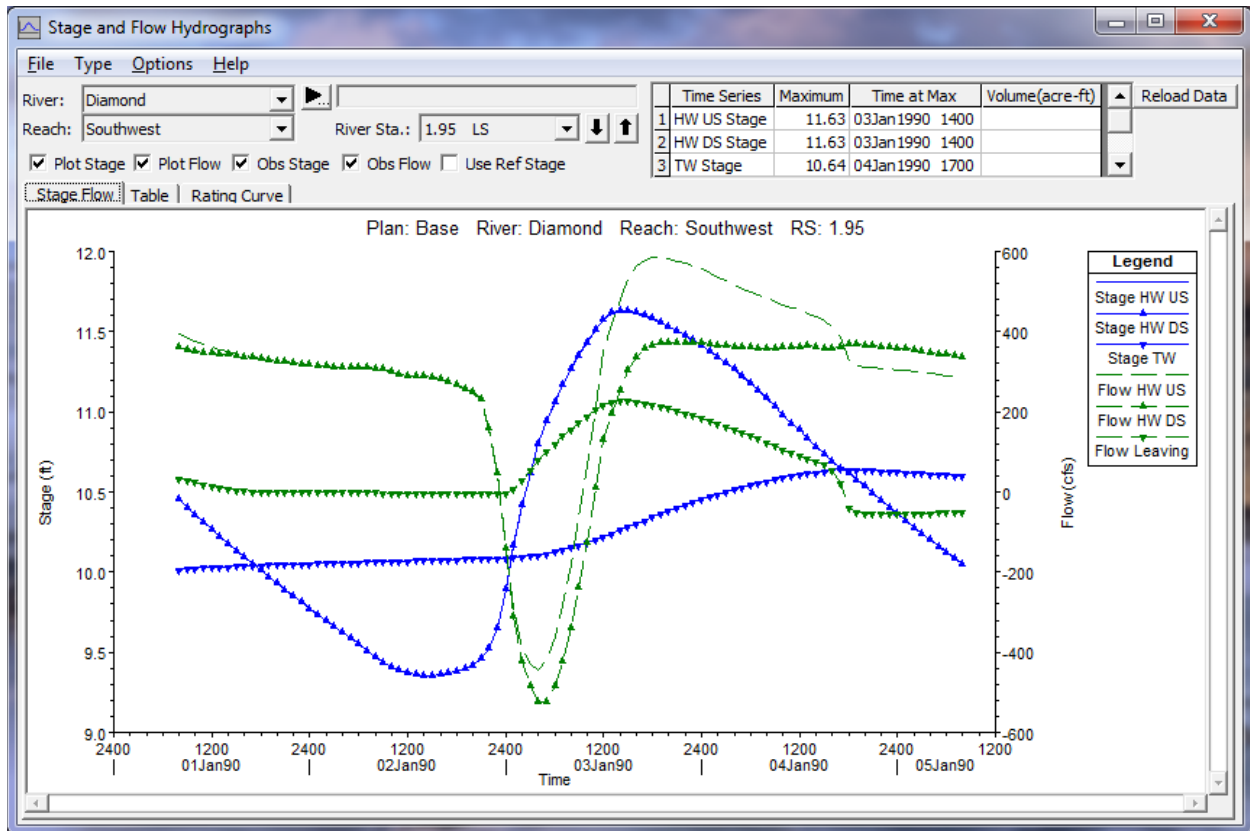

Figure 17-23: Stage and Flow Hydrograph for Lateral Structure Located on the Southwest Reach

In addition to viewing output directly from the **Stage and Flow Hydrograph Window** the user can open the **Geometric Data Editor** and select to view output by clicking on the desired feature. From the **Geometric Data Editor** the storage area "Pyramid" was selected by clicking on it with the mouse. **Plot Stage and Flow Hydrograph** was selected, displaying Figure 17.24.

As shown in Figure 17.24, the stage of the storage area steadily decreases because flow is leaving the storage area until the floodwave passes through, causing the stage to increase. The stage of the storage area then begins to decrease again after the floodwave.

Example 17 Unsteady Flow Application

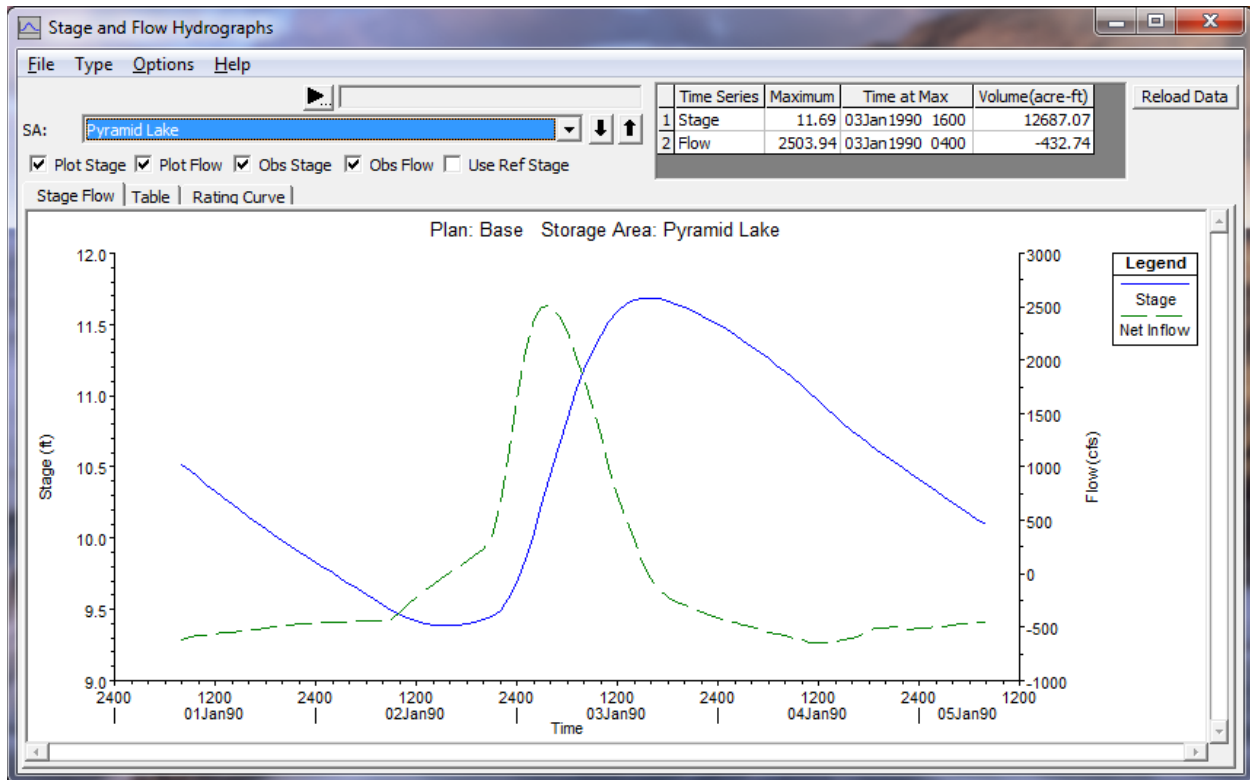

Figure 17-24: Stage and Flow Hydrograph for Pyramid Lake

Finally, from the **Geometric Data Editor** the storage are connection “Pyramid to Eagle” was selected, displaying Figure 17.25. Initially, there is no flow in this connection. This occurs because the stage is below the low invert elevation of the culvert at 11.5 feet. When the stage increases to over 11.5 feet the flow rate steadily increases, as shown on Figure 17.25.



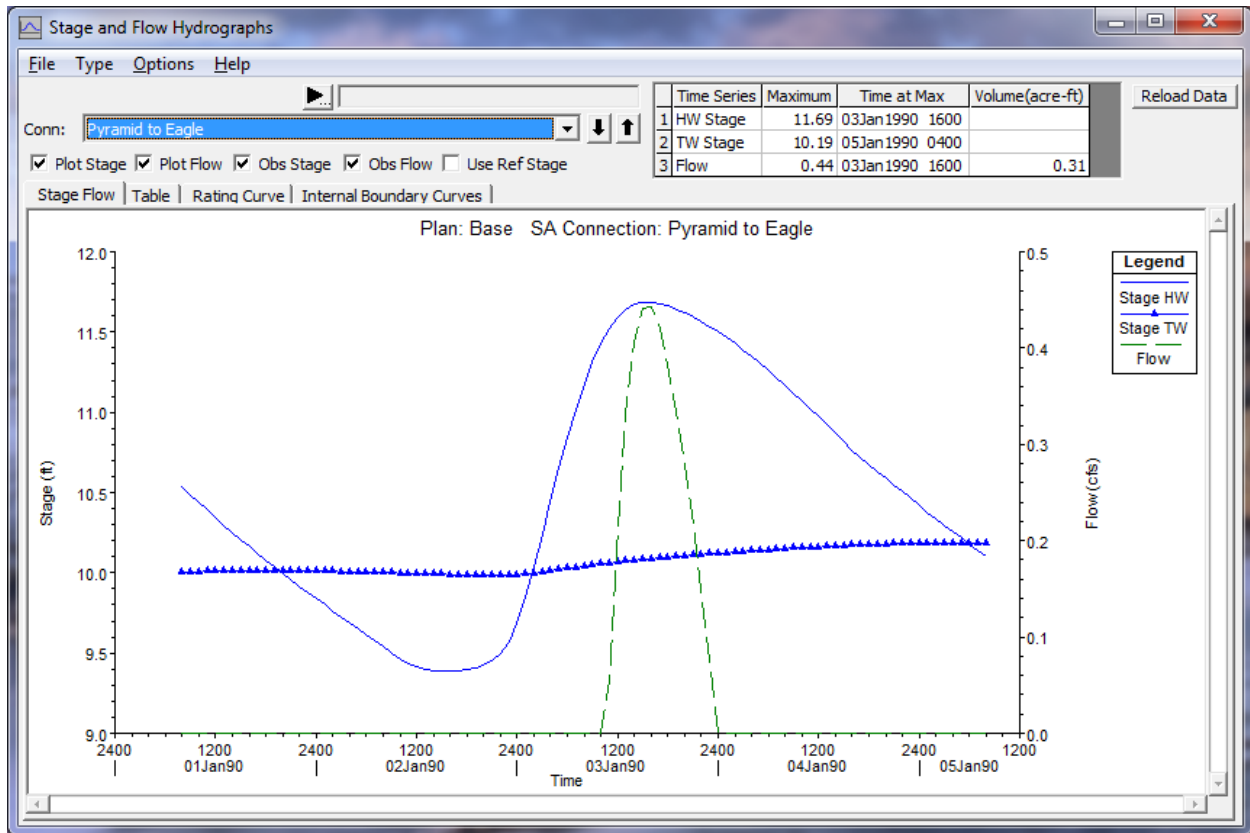

Figure 17-25: Stage and Flow Hydrograph for Hydraulic Connection – Pyramid to Eagle

## Summary

The concept of unsteady flow analysis within a network of channels and storage areas was discussed. This example demonstrates the ability of HEC-RAS to route a hydrograph through a network of channels containing junctions, culverts, bridges, storage areas, lateral weirs, and hydraulic connections.

Unsteady flow analysis can be extremely difficult compared to steady flow analysis because input parameters can cause instabilities in calculations. Instabilities can cause the program to fail to converge on a solution. It is highly recommended that the user have experience with unsteady flow modeling. Refer to Chapter 8 of the User's Manual for additional information on unsteady flow analysis.



## CHAPTER 18

## Advanced Inline Structure Modeling

### Purpose

This example will demonstrate the use of HEC-RAS to analyze a river reach that contains an inline structure that features a weir, gated spillway, culverts, outlet rating curve, and inline time series outlet. Emphasis is given to demonstrating how to utilize the *Inline Culvert*, *Outlet RC*, and *Outlet TS* functions.

To perform the analysis the user must enter the geometric data for the various inline structure components along with the geometry of the river reach. Then, the user must enter the rating curve for the Outlet RC function, a flow hydrograph for the Outlet TS, and a time series gate opening for the gated spillway. The flow hydrograph and the time series gate opening are entered as internal boundary conditions in the Unsteady Flow Editor. The modeler is referred to Chapter 6 of the User's Manual for discussion on entering the geometric data for the weir, culverts, and gated spillway; Chapter 8 of the User's Manual for entering the gate opening flow data; Chapter 6 of the Hydraulic Reference Manual for the hydraulic analysis procedures for analyzing the flow through the culverts; and Chapter 8 of the Hydraulic Reference Manual for the hydraulic analysis procedures for analyzing the flow through the gate openings and over the weir.

To review the data files for this example, from the main HEC-RAS window, select **File** and then **Open Project**. Go to the directory in which you have installed the HEC-RAS example data sets. From the "**Applications Guide\Chapter 18 – Advanced Inline Structure**" subdirectory, select the project labeled "**Advanced Inline Structure Example**." This will open the project and activate the following files:

Plan:	"Unsteady Flow – Inline Structure"
Geometry:	"Beaver Cr. – Adv Inline Structure"
Flow:	"Unsteady Flow Data"

### Geometric Data

To view the geometric data for the river system, from the main program window select **Edit** and then **Geometric Data**. This will activate the **Geometric Data Editor** and display the river system schematic as shown in

Figure 18.1. The schematic displays the 59 river stations of the reach “Kentwood” on “Beaver Creek”, with river station 5.99 as the upstream cross section and 5.0 as the downstream cross section. In addition to the inline structure, the river reach has a lateral structure that is connected to a storage area. For further information on modeling lateral structures connected to a storage area see “**Unsteady Flow Application – Example 17.**”

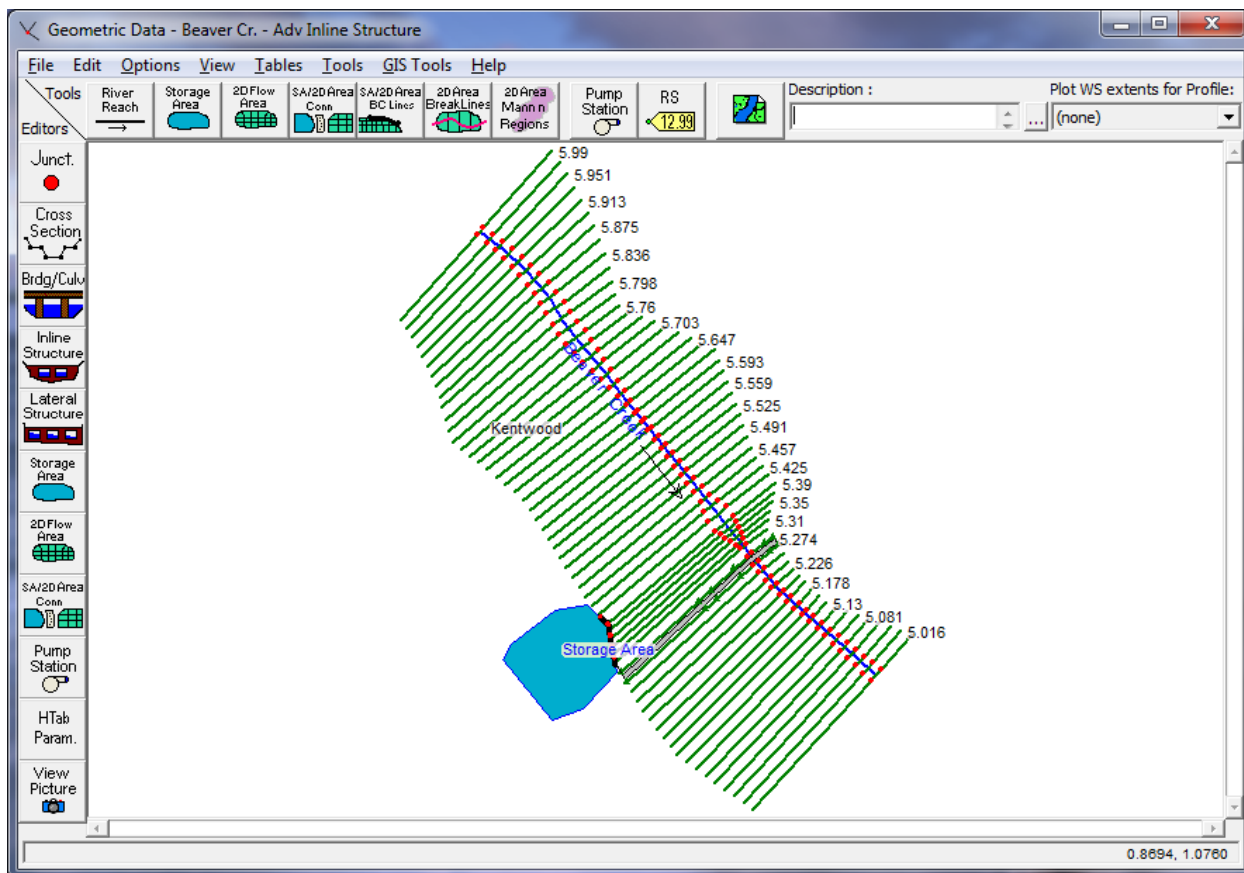

Figure 18-1. River System Schematic for Beaver Creek

## General Geometric Features

### Cross Section Data

The cross section data consists of the X-Y coordinates, Manning's n values, contraction and expansion coefficients, etc. The user can view this data for each river station by selecting the **Cross Section** icon on the left side of the **Geometric Data Editor**. For this example, an inline structure was added at river station 5.26 and will be discussed in the next section.

### **Cross Section Placement**

The placement of the cross sections in reference to the inline structure should be treated much like that for bridges and culverts. The flow will contract to enter the various inline structure openings and expand after exiting the openings. The program will use four cross sections located on both sides of the structure to define the contraction and expansion of the flow through the structure. To provide guidance for the expansion reach length and contraction reach length, the tables in Appendix B of the **Hydraulic Reference Manual** were utilized. These tables were developed based on data for flow through bridges; however, they were used to provide general guidance. For further guidance on cross section placement for inline structures look to "**Inline Structure - Example 12**" as well as Chapter 6 of the **User's Manual**.

### **Ineffective Flow Areas**

As performed for bridges and culverts, ineffective flow areas should be entered on the cross sections that bound the inline structure. For this example, the cross section that is upstream of the structure is 5.274 and the cross section downstream of the structure is 5.258. For further information on placing ineffective flow areas for inline structures see "**Inline Structure - Example 12**" as well as Chapter 6 of the **User's Manual**.

### **Inline Structure**

To add an inline structure, the **Inline Structure** icon was selected from the left side of the **Geometric Data Editor**. This activated the **Inline Structure Data Editor** as shown in Figure 18.2. Next, **Options** and **Add an Inline Structure** were selected and river station 5.26 was entered as the location for the inline structure. The schematic then displayed the cross section data for the river station immediately upstream of the inline structure location: namely river station 5.274 for this example.

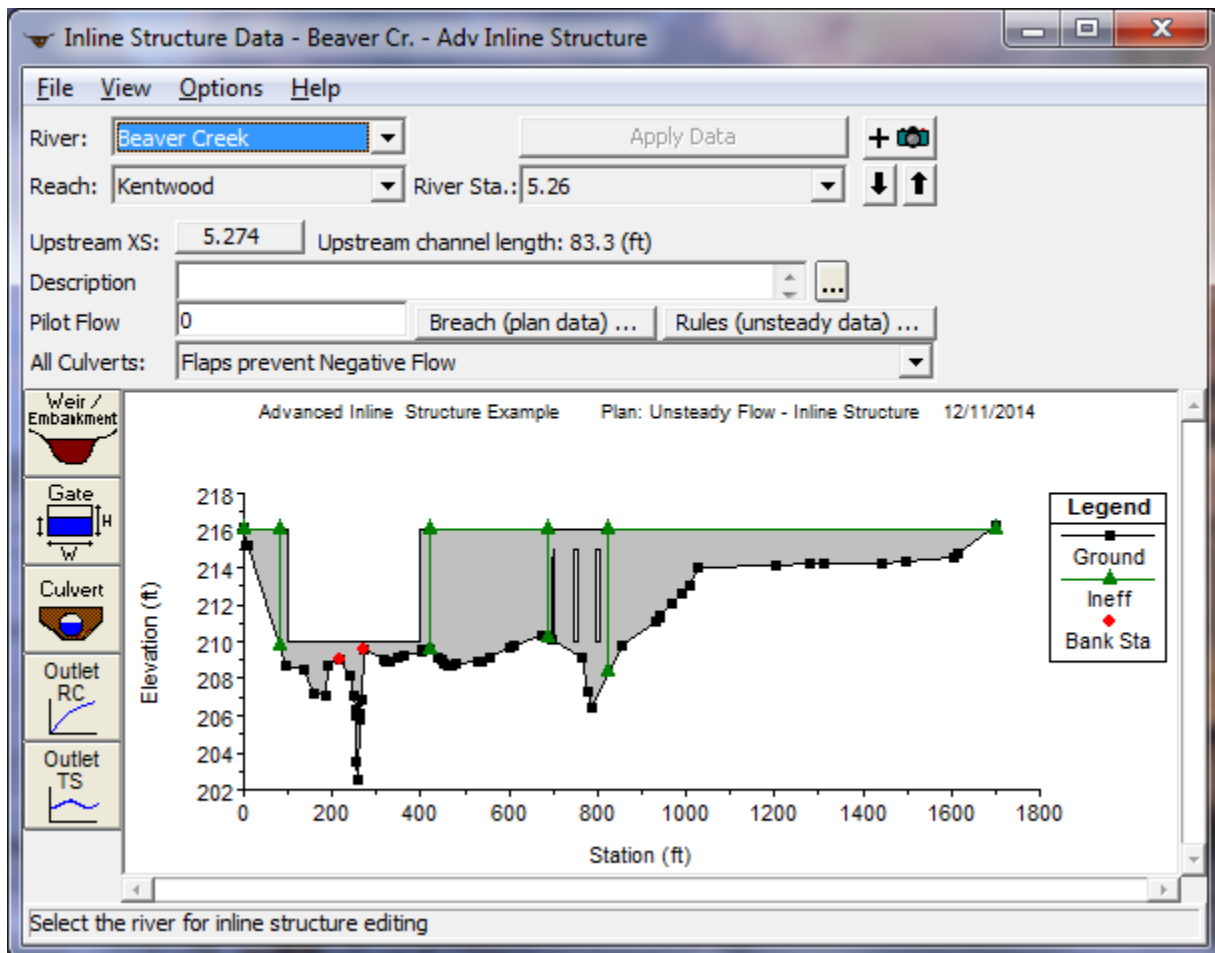

Figure 18-2. Inline Structure Data Editor

Since there are no flap gates on the culverts, **No Flap Gates** was selected from the **All Culverts** dropdown menu in the center of the **Inline Structure Data Editor**. “Flaps prevent Negative Flow” can be selected in cases where flap gates prevent the inline structure’s tailwater from propagating upstream through the culverts. (e.g. Immediately downstream of the inline structure the river empties into a bay whose tidal fluctuations are impeded at the culverts by flap gates.) “Flaps prevent Positive Flow” prevents the culverts from passing flow from upstream to downstream; however, flow can pass from downstream to upstream.

### **Weir/Embankment**

To enter the data for the weir, the **Weir/Embankment** icon was selected from the left side of the **Inline Structure Data Editor**. This activated the **Inline Structure Weir Station Elevation Editor** as shown in Figure 18.3. This editor is similar to the deck/roadway editor used for bridges and culverts. Further insight and instruction on the Weir/Embankment function can be

found in “**Inline Structure – Example 12**” and Chapter 6 of the **User’s Manual**.

Distance	Width	Weir Coef
20	40	3.87

Edit Station and Elevation coordinates	
Station	Elevation
1 0.	216.
2 100.	216.
3 100.	210.
4 400.	210.
5 400.	216.
6 1800.	216.
7	
8	

U.S Embankment SS: 0      D.S Embankment SS: 0

**Weir Data**  
**Weir Crest Shape**  
 Broad Crested  
 Ogee

Spillway Approach Height: 4  
 Design Energy Head: 5      **Cd ...**

OK      Cancel

Enter distance between upstream cross section and deck/roadway. (ft)

Figure 18-3. Inline Structure Station Elevation Data Editor

### Gated Spillways

To enter the data for the gates, the **Gate** icon was selected from the **Inline Structure Data Editor** (Figure 18.2). This activated the **Inline Gate Editor** as shown in Figure 18.4. For this example, one sluice gate was entered.

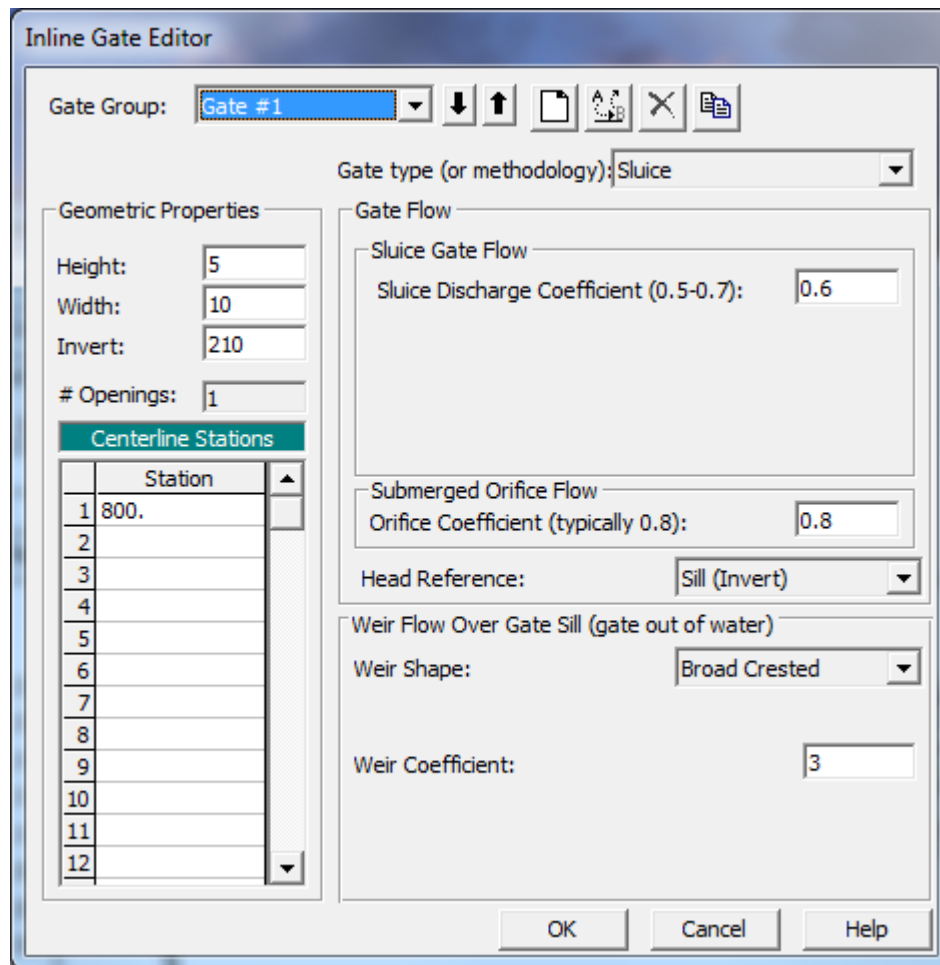

Figure 18-4. Inline Gate Editor

When the **Inline Gate Editor** was activated, the first gate was automatically labeled as "Gate #1." The *Height*, *Width*, and *Invert* for the gate were entered as 5, 10, and 210 feet, respectively. On the lower left side of the editor, the centerline station for the gate was entered as shown in Figure 18.4. The *# Openings* automatically updates to coincide with the number of centerline stations entered. In this case there is only one opening.

The remaining portion of the editor is divided into two sections, one for the Gate Flow data and one for Weir Flow data. For the gate data, the first field is the *Gate Type*. For this example the gate type was left at the default type "Sluice". The *Sluice Discharge Coefficient* was entered as 0.6, while the default value of 0.8 was used for the *Orifice Coefficient*. The orifice coefficient is only used for fully submerged flow conditions. Additionally, the head reference for the gate equation defaults to the "Sill (invert)" of the gate opening.



For the Weir Flow data, the *Weir Shape* was kept at the default shape of “Broad Crested” and the Weir Coefficient was kept at the default value of three.

The **OK** button was selected at the bottom of the **Gate Editor** and the gate appeared on the **Inline Structure Data Editor** as shown in Figure 18.2. (Note: The ineffective flow areas will be entered after entering all the geometric data for the inline structure components.) At this point, the user should zoom in on the gate opening to ensure that they do not overlap with other features and appear as intended. The **Inline Structure Data Editor** was then closed.

### Culverts

To enter the data for the culverts, the **Culvert** icon was selected from the **Inline Structure Data Editor** (Figure 18.2). This activated the **Culvert Data Editor** as shown in Figure 18.5. The **Culvert Data Editor** for the inline structure is identical to the one used under the Bridge/Culvert icon found in the **Geometric Data Editor**. In this example two culverts were used, one circular culvert and one box culvert. For more information on entering culvert data refer to “**Single Culvert (Multiple Identical Barrels) Example 3**” and “**Multiple Culverts Example 4**”.

**Culvert Data Editor**

Add ... Copy Delete ... Culvert ID: Culvert #1

Solution Criteria: Highest U.S. EG Rename ...

Shape: Circular Span: Diameter: 5

Chart: 1 - Concrete Pipe Culvert

Scale #: 1 - Square edge entrance with headwall

Distance to Upstrm XS: 10 Upstream Invert Elev: 210

Culvert Length: 63 Downstream Invert: 209.9

Entrance Loss Coeff: 0.5 # identical barrels: 1

Exit Loss Coeff: 1

Manning's n for Top: 0.015

Manning's n for Bottom: 0.015

Depth to use Bottom n: 0

Depth Blocked: 0

Centerline Stations		
	Upstream	Downstream
1	700.	700.
2		
3		
4		

OK Cancel Help

Select culvert to edit

Figure 18-5. Inline Culvert Data Editor

### Outlet Rating Curve

Next, the **Outlet RC** icon was selected. The Outlet RC feature allows the user to account for inline structure discharges that can't be properly modeled by the weir, gate, or culvert features.

Once the Outlet RC icon was selected, a window appeared that provided a table to enter the rating curve information (Figure 18.6). The radio button **Outlet flow based on water surface upstream** was selected to signify that the relationship between the diversion flows from the structure has a direct correlation to the upstream water surface elevation. If the diversion flow was instead based on the upstream flow rates then the *Outlet flow based on flow upstream* radio button would be selected, causing the heading of the first column of the table to change from *US WS Elev* to *US Flow*.

	Chan WS Elev	Div Flow
1	210	0
2	212	100
3	214	200
4	216	400
5	218	400
6		
7		
8		
9		
10		
11		
12		
13		
14		
15		
16		
17		
18		
19		
20		
21		
22		
23		
24		
25		

Figure 18-6. Inline Structure Outlet Rating Curve Editor

The outlet rating curve table was filled in with the values seen in Figure 18.6. It should be noted that if the calculated water surface elevation is outside the upper or lower bounds of the rating curve the program uses the two nearest points on the rating curve to linearly extrapolate a diversion flow value to correspond to the calculated water surface elevation. Once the values are entered in the table, the resulting rating curve can be plotted and graphically inspected by clicking **Plot Curve**. The outlet's rating curve is plotted in a separate window as seen in Figure 18.7. After filling in the table and viewing the plot, click the **OK** button in the lower right hand corner of the **Inline Structure Outlet Rating Curve** window.

**Note: The Outlet Rating Curve option only supports single value rating curves and non tailwater influenced outlets. If you have a tailwater influenced outlet that requires a family of curves, use the "User Define Curves" option within the Gate editor.**

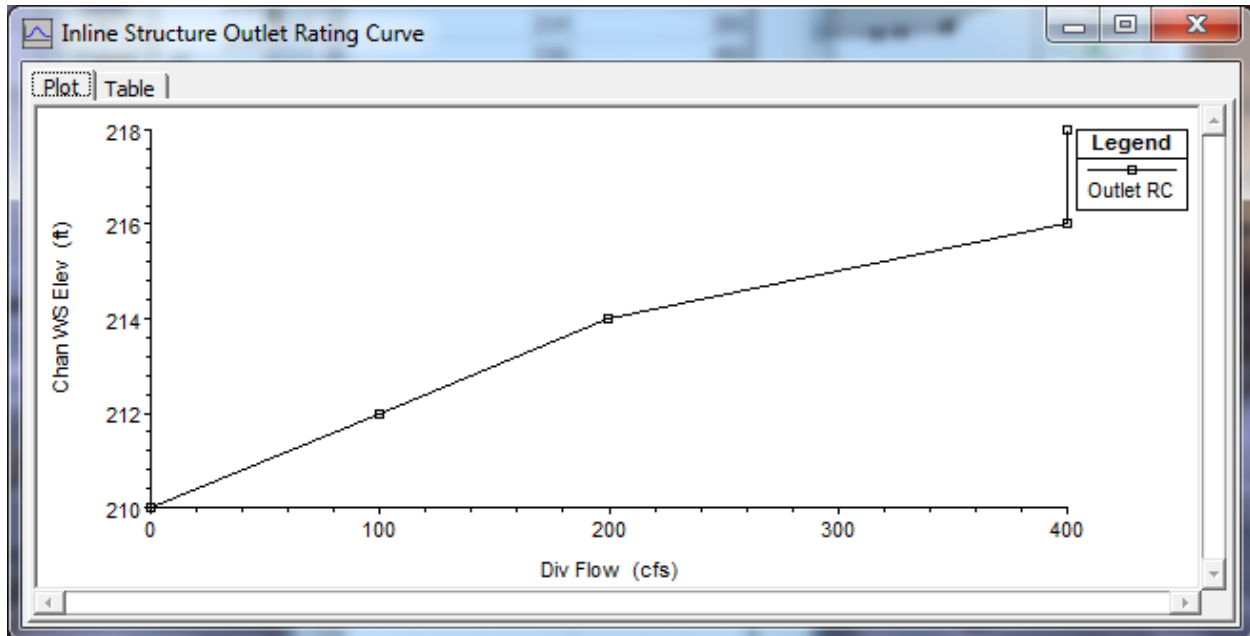

Figure 18-7. Inline Structure Outlet Rating Curve Editor

### Time Series Outlet

Time series outlets are used to account for time dependent flow releases that take place at the inline structure. Often times, as with this example, this feature is used to model the flow going through a hydropower facility adjacent to the inline structure.

First, the **Outlet TS** icon from the **Inline Structure Data Editor** (Figure 18.2) was selected to signify that a time series outlet exist at the specified location. This activated the **Inline Structure Time Series Outlet** window as

shown in Figure 18.8. The name given to the time series outlet was "HydroPower". After naming the outlet, press **OK**.

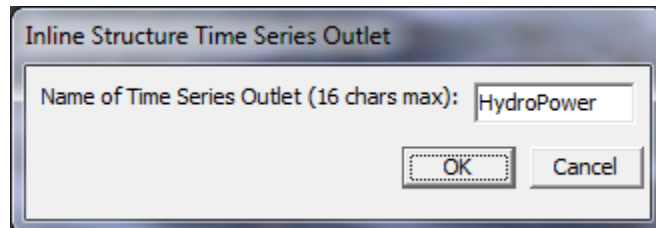

Figure 18-8. Inline Structure Time Series Outlet Editor

The time series outlet is time dependent; therefore, the operation of the outlet is event specific and cannot be entered in as geometric data like the other inline features. Instead, a flow hydrograph is created at the inline structure cross section as an internal boundary condition in the **Unsteady Flow Editor**. The name given to the time series outlet (i.e. "HydroPower") is not seen on the Unsteady Flow Editor; however, the title does appear on the various output tables once the model is computed. How to enter the flow hydrograph in the **Unsteady Flow Editor** will be explained further in the next section.

## Unsteady Flow Data

The user is required to enter boundary conditions and initial conditions for the system at the beginning of the simulation period. For additional information on unsteady flow data refer to Chapter 8 of the User's Manual, Performing an Unsteady Flow Analysis. The **Unsteady Flow Data Editor**, shown in Figure 18.9, was selected from the main program window under the **Edit** menu.

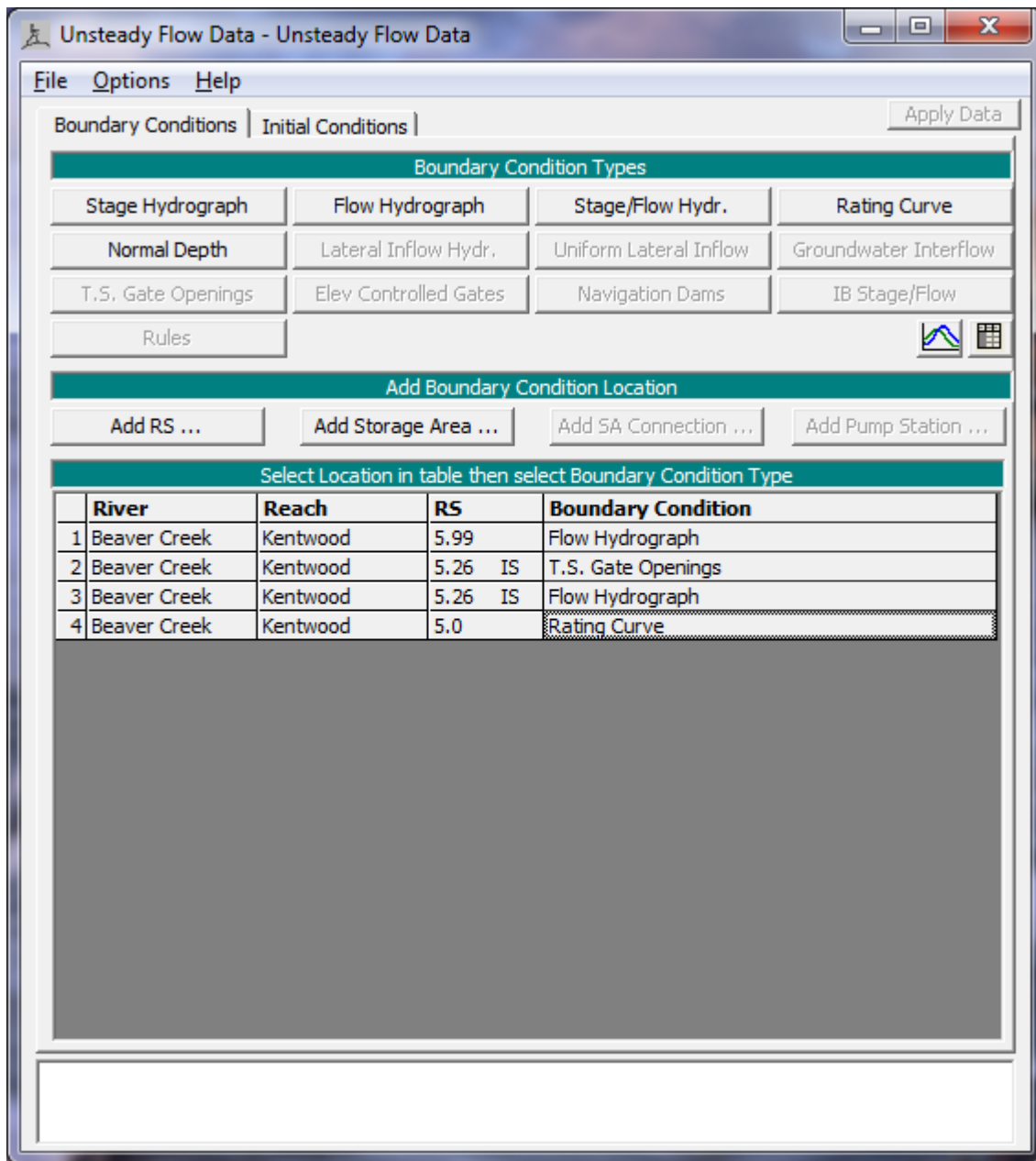

Figure 18-9. Unsteady Flow Data Editor

### Boundary Conditions

Boundary conditions are required for the farthest upstream and downstream cross sections. Upon entering the **Unsteady Flow Data Editor** the farthest upstream and downstream cross sections will be located in the boundary conditions column. In this case, the user will see River Station 5.99 and River Station 5.0 as the upstream and downstream boundary conditions,

respectively. Boundary conditions are set by highlighting the adjacent cell under **Boundary Condition Type**. When a cell is highlighted, not all boundary conditions are available. The program will automatically gray out all irrelevant boundary condition types. Internal boundary conditions may be added by selecting one of the buttons under the "Add Boundary Condition Location" heading.

### **Upstream Boundary Condition**

For River Station 5.99 a flow hydrograph was selected by highlighting the cell and pressing the **Flow Hydrograph** button. The window for a **Flow Hydrograph** is shown in Figure 18.10. The user may select to read hydrograph data from a DSS file or manually enter the data. For further instruction on using a DSS file see *Unsteady Flow Application Example 17*. For this example the flow hydrograph was manually entered by selecting the **Enter Table** radio button. The **Data Time Interval** was set to one hour and the radio button **Use Simulation Time** was selected causing the initial propagation of the hydrograph to coincide with the beginning of the simulation time window. The hydrograph was then manually entered into the table.

**Flow Hydrograph**

River: Beaver Creek Reach: Kentwood RS: 5.99

Read from DSS before simulation Select DSS file and Path

File:

Path:

Enter Table Data time interval: 1 Hour

Select/Enter the Data's Starting Time Reference

Use Simulation Time: Date: 10FEB1999 Time: 0000

Fixed Start Time: Date:  Time:

No. Ordinates    Interpolate Missing Values    Del Row    Ins Row

Hydrograph Data			
	Date	Simulation Time (hours)	Flow (cfs)
1	09Feb 1999 2400	00:00	3046.56
2	10Feb 1999 0100	01:00	3185.75
3	10Feb 1999 0200	02:00	3416.02
4	10Feb 1999 0300	03:00	3734.86
5	10Feb 1999 0400	04:00	4138.78
6	10Feb 1999 0500	05:00	4623.36
7	10Feb 1999 0600	06:00	5183.27
8	10Feb 1999 0700	07:00	5812.39
9	10Feb 1999 0800	08:00	6503.83
10	10Feb 1999 0900	09:00	7250.

Time Step Adjustment Options ("Critical" boundary conditions)

Monitor this hydrograph for adjustments to computational time step

Max Change in Flow (without changing time step):

Min Flow:  Multiplier:

Plot Data    OK    Cancel

Figure 18-10. Flow Hydrograph for Upstream Boundary Condition

### Downstream Boundary Condition

For River Station 5.0 the boundary condition selected was a rating curve. Again, the corresponding cell for that particular river station was highlighted and the **Rating Curve** button was selected. The window shown in Figure 18.11 is then displayed and the user is given a choice whether to *Read from DSS before simulation* or *Enter Table*. For this example the **Enter Table** radio button was selected and the stage and flow values were entered in the appropriate units.

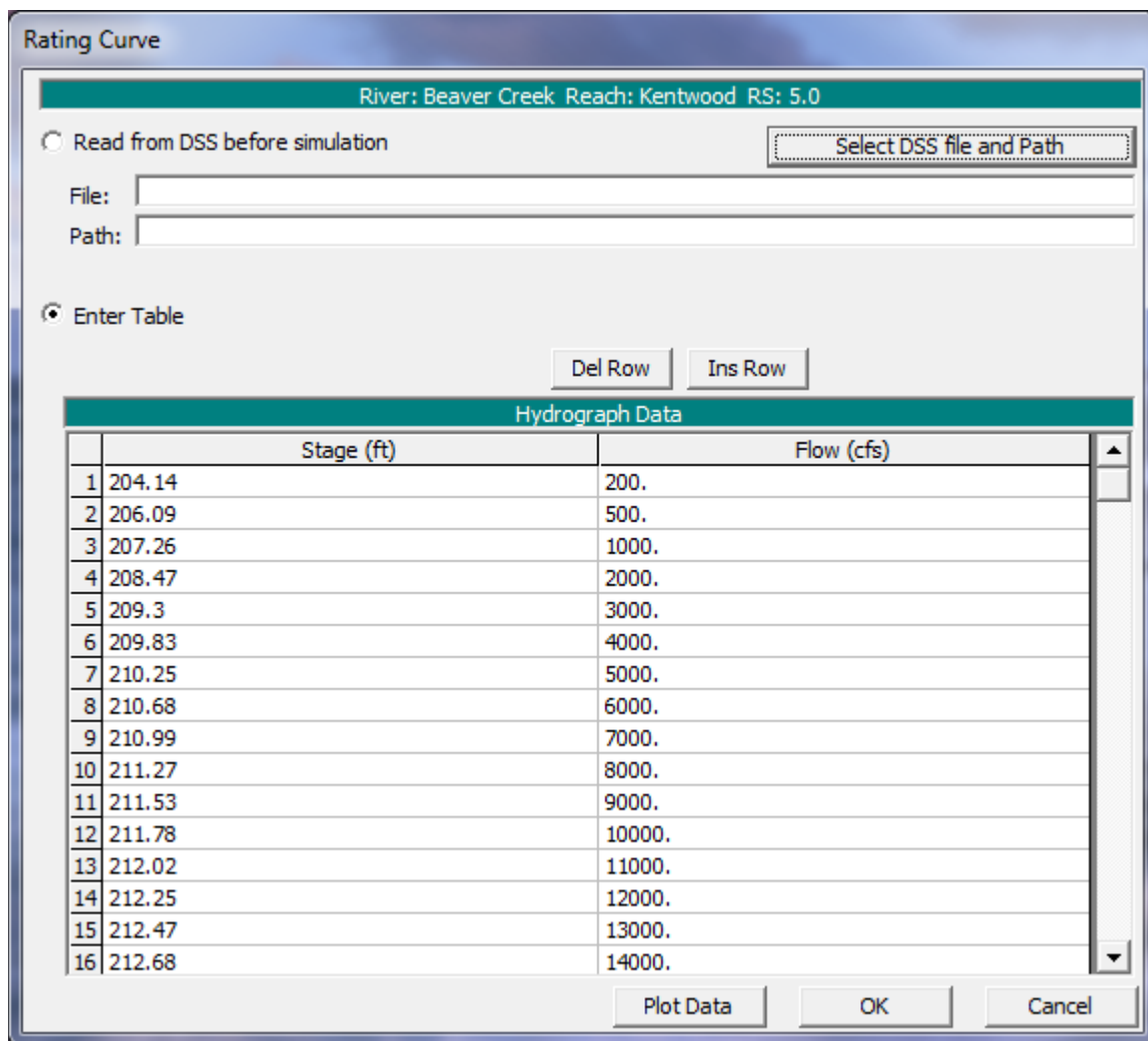

Figure 18-11. Rating Curve for Downstream Boundary

### Internal Boundary Conditions

Two internal boundary conditions were entered at River Station 5.26 for the gate and Outlet TS (titled "HydroPower" in this example) of the inline structure. A new boundary condition was entered by selecting **Add RS** from the Unsteady Flow Data window, and specifying the desired river station location (5.26). Once the desired river station was selected and appeared in the *Selected Locations* box, the **OK** button was clicked. The River Station 5.26 was populated in the Boundary Conditions Table. The "IS" that appears next to River Station 5.26 signifies that there is an inline structure at that location. The corresponding cell next to River Station 5.26 was highlighted under the *Boundary Condition* column and the **T.S. Gate Openings** button was selected for the first internal boundary condition.



Upon selecting **T.S. Gate Openings** as the boundary condition a window opens up titled "Gate Openings". The radio button **Enter Table** was selected. The *Data time interval* dropdown was kept at the default of 1 Hour. Under *Select/Enter the Data's Starting Time Reference* the **Use Simulation Time** radio button was selected, automatically filling in the *Date* and *Time* fields. The only remaining field to be populated was the **Gate Opening Height**. In this example the gate height remained constant at five feet (see Figure 18.12). Once all the data was entered, the window was closed and the data was stored by clicking **OK**.

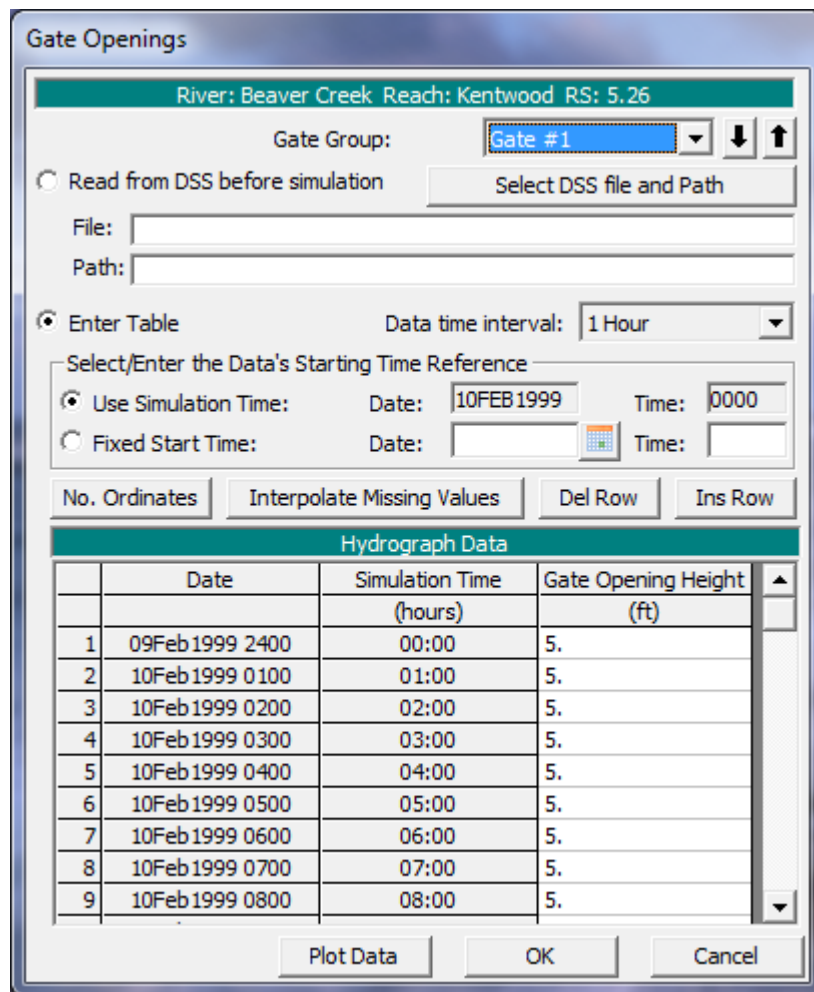

Figure 18-12. Gate Openings Editor

Next, the corresponding cell for the other internal boundary condition (also at RS 5.26 IS) was highlighted under the *Boundary Condition* column. The **Flow Hydrograph** was chosen to represent the time series outlet titled

“HydroPower”. The Flow Hydrograph data entry window that appears has the same inputs as the T.S. Gate Openings boundary condition just completed. The same parameters were entered for both with the exception of the flow values under the *Flow* column under the **Hydrograph Data** table. Since the hydrograph represents the flow of a hydroelectric facility, there is some daily variability in the flows (as seen in Figure 18.13). In this example, there is zero flow during the hydro facility’s non-peak hours (8 p.m. – 6 a.m.), 150 cfs flow from 6 a.m. – 3 p.m., and during peak energy demand hours (3 p.m. – 8 p.m.) there is 220 cfs diverted through the hydropower facility. Once all the data was entered, the window was closed and the data was stored by clicking **OK**.

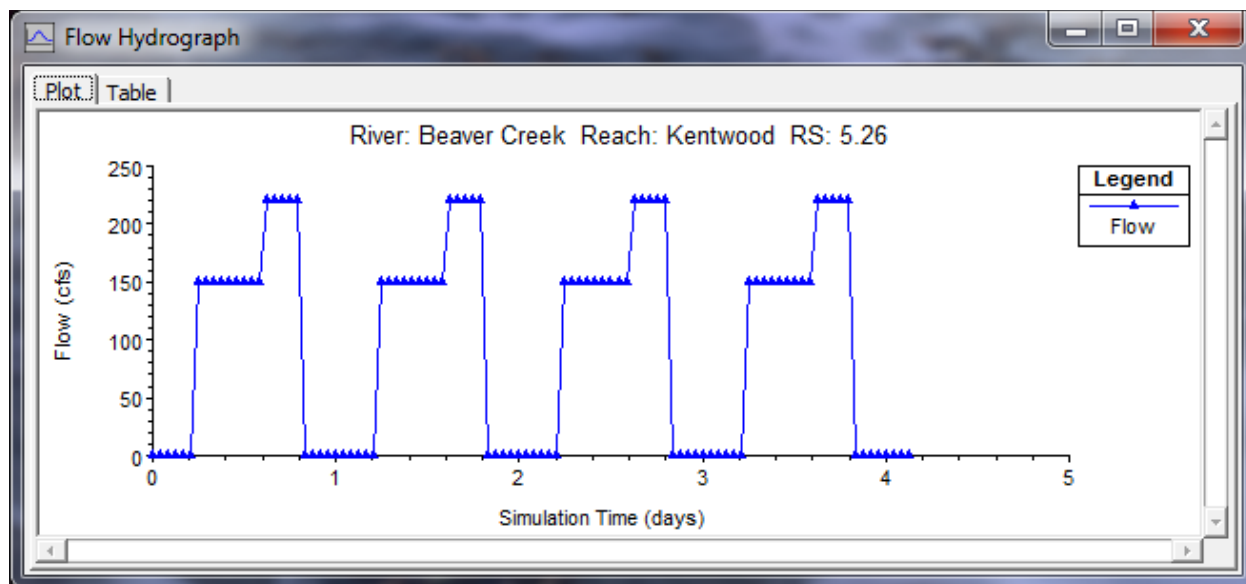

Figure 18-13. HydroPower’s Flow Hydrograph Plot

### Initial Conditions

Initial conditions consist of flow and stage information at each of the specified cross sections, as well as elevations for any storage areas defined in the system. Data for initial conditions is established by selecting the **Initial Conditions** tab on the **Unsteady Flow Data Editor**. After selecting the tab, Figure 18.14 will be displayed.

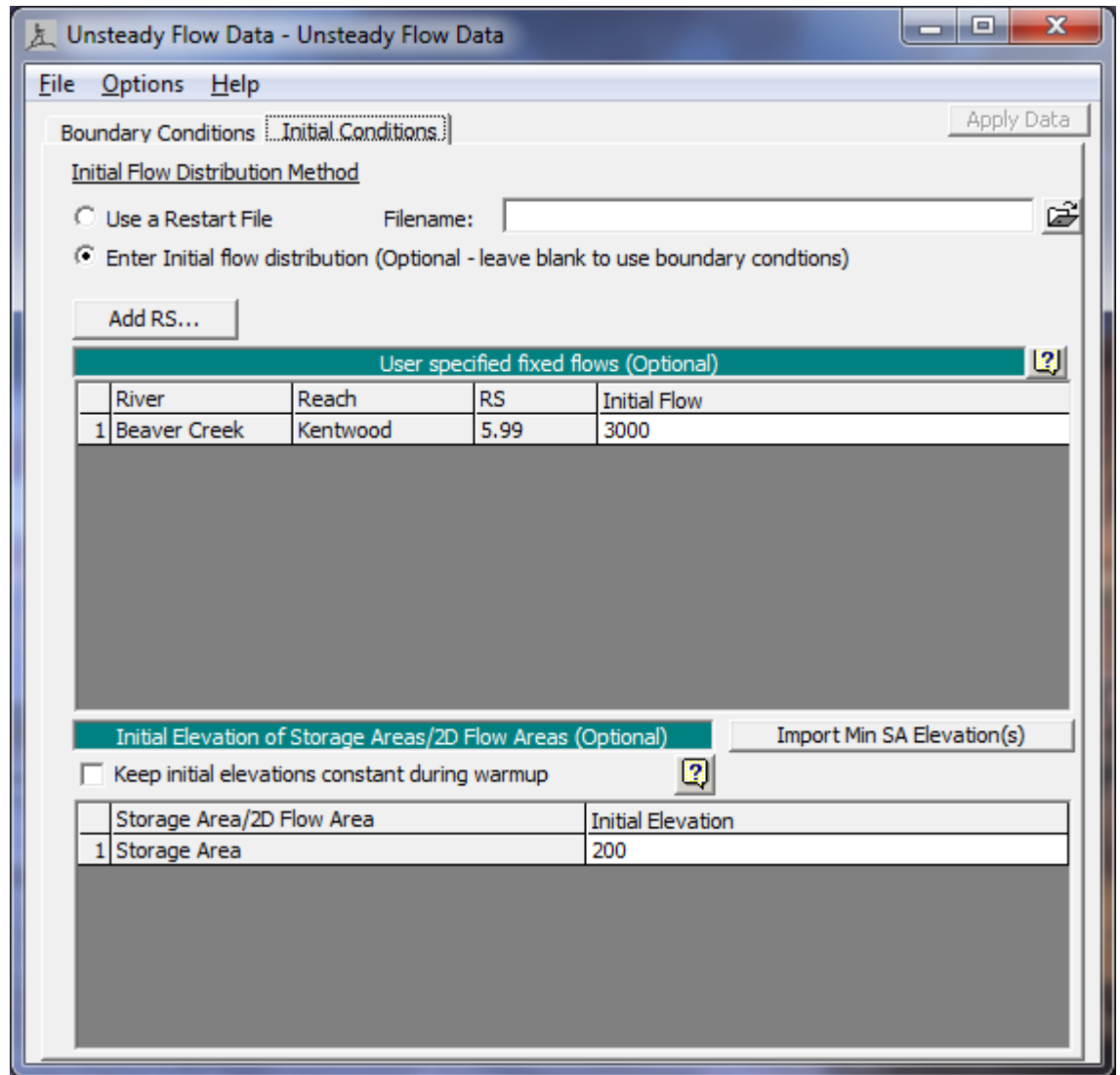

Figure 18-14. Unsteady Flow Data Initial Conditions

As seen in Figure 18.14, the **Enter Initial flow distribution** radio button was selected and an initial flow of 3000 was entered for the most upstream river station (5.99). In addition to flow data, the initial elevation for the storage area is needed. The initial elevation of the storage area was set to 200. The data was then saved (**File -> Save Unsteady Flow Data As...**) in the **Unsteady Flow Data Editor** and the window was closed.

## Unsteady Flow Analysis

After the geometry and unsteady flow data have been completed an unsteady flow analysis may be initiated. Under the main program window **Unsteady**

**Flow Analysis** was selected under the **Run** menu; this displayed the **Unsteady Flow Analysis Window** shown in Figure 18.15. A plan was defined by selecting the Geometry File "Beaver Cr. – Adv Inline Strc" and the Unsteady Flow File "Unsteady Flow." Under the **File** menu, **Save Plan As** was selected and the plan title was entered as "Unsteady Flow - Inline." After entering the title of the plan a short identifier was entered as "Unsteady Inline" and the plan was saved. For more information on the Simulation Time Window, Computation Settings, and Location of Stage and Flow Hydrographs (Under Options) refer to "**Unsteady Flow Application – Example 17**".

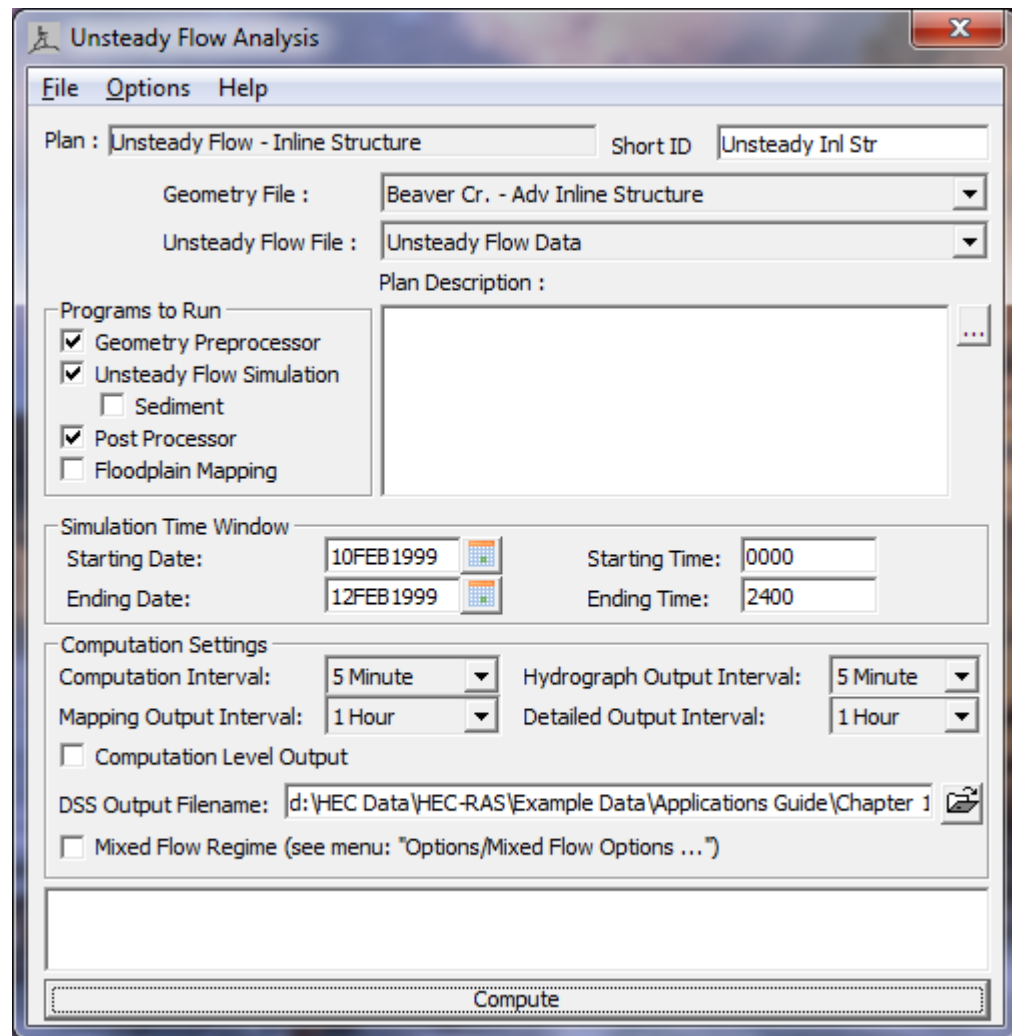

Figure 18-15. Unsteady Flow Analysis

## Output Analysis

For the analysis of the output, the water surface profiles, the inline structure type cross section table, and the inline structure type profile table will be reviewed. Each of these is discussed in the following sections.

### Water Surface Profiles

The water surface profiles are shown in Figure 18.16. This figure was activated from the main program window by selecting **View** and then **Water Surface Profiles**. The figure shows the maximum water surface elevation. The entire event can be seen as an animation by selecting **Options** and then **Animate** from the profile plot window.

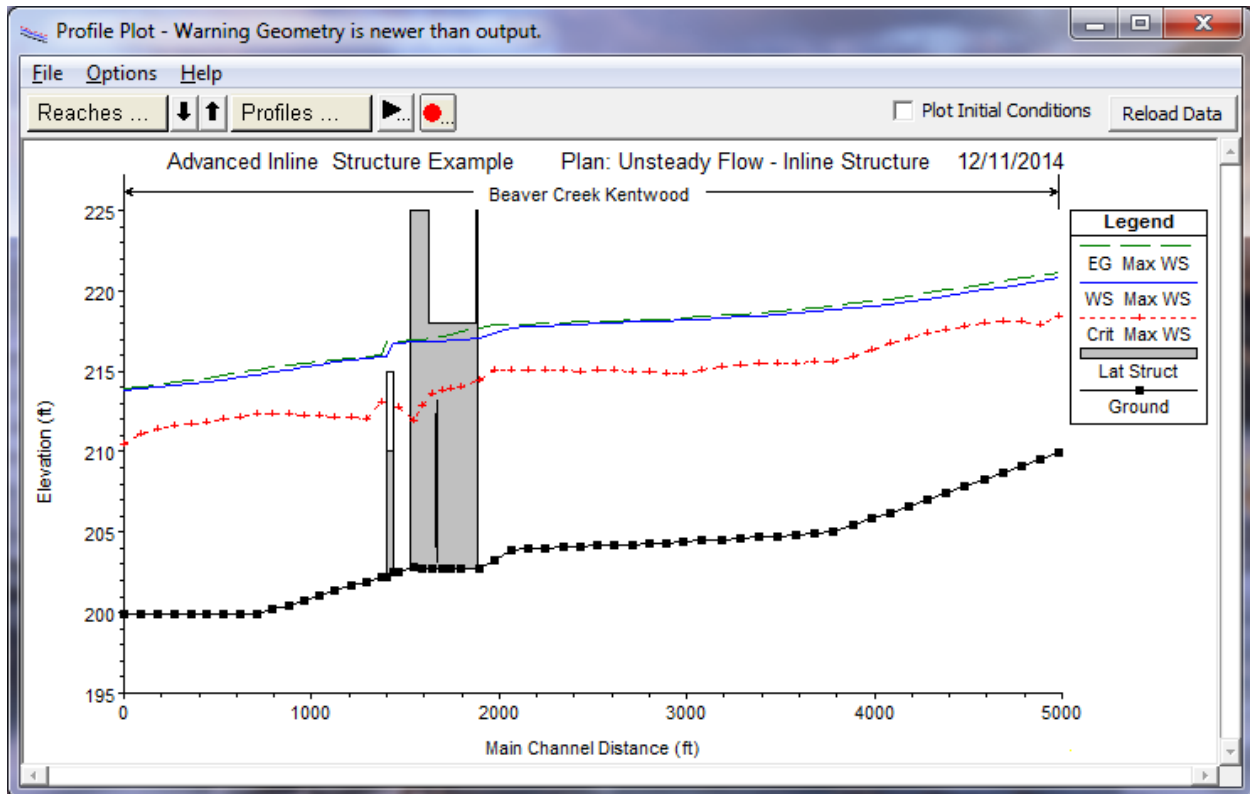

Figure 18-16. Water Surface Profiles for Beaver Creek

### Inline Structure Detailed Output Table

To review the flow parameters through the inline structure components, the **Inline Structure** type **Detailed Output Table** was activated and is shown in Figure 18.14. This table was activated from the main program window by selecting **View**, **Detailed Output Table**, **Type**, and then **Inline Structure**.

At the top of the table, the profile “Max WS” was selected. The table itself is broken into two columns. The first column lists the energy grade and water surface elevations, a summary of all discharges from the inline structure, and breach information (not applicable in this example). The second column gives more detail on the performance of the weir and gate structures. The **Inline Structure Output** table can be seen in Figure 18.17.

Plan: Unsteady Inl Str		Beaver Creek		Kentwood		RS: 5.26		Gate Group: Gate #1		Profile: Max WS	
E.G. Elev (ft)			216.84	Weir Sta Lft (ft)							0.00
W.S. Elev (ft)			216.74	Weir Sta Rgt (ft)							1702.50
Q Total (cfs)			19948.83	Min El Weir Flow (ft)							210.01
Q Weir (cfs)			18883.73	Wr Top Wdth (ft)							1702.50
Q Gates (cfs)			291.34	Weir Max Depth (ft)							6.82
Q Culv (cfs)			372.17	Weir Avg Depth (ft)							1.88
Q Inline RC (cfs)			400.00	Weir Flow Area (sq ft)							3202.47
Q Outlet TS (cfs)			0.00	Weir Coef (ft <sup>1/2</sup> )							3.891
Q Breach (cfs)				Weir Submerg							0.70
Breach Avg Velocity (ft/s)				Q Gate Group (cfs)							291.34
Breach Flow Area (sq ft)				Gate Open Ht (ft)							5.00
Breach WD (ft)				Gate #Open							1
Breach Top El (ft)				Gate Area (sq ft)							50.00
Breach Bottom El (ft)				Gate Submerg							0.86
Breach SSL (ft)				Gate Invert (ft)							210.00
Breach SSR (ft)				Gate Weir Coef							

**Errors, Warnings and Notes**

**Note:** Multiple critical depths were found at this location. The critical depth with the lowest, valid, energy was used.

Area of the flow going over the weir.

Figure 18-17. Inline Structure Output Table for Max WS Profile

### Inline Structure Profile Summary Table

Finally, the **Inline Structure Profile Summary Table** is shown in Figure 18.18. This figure was activated from the main program window by selecting **View, Profile Summary Table, Std. Tables**, and then **Inline Structure**. The figure displays the water surface elevations, energy grade line, and total weir and gate flows for each of the profiles. The advantage of this table over

the *Inline Structure Detailed Output Table* is that the user can compare all the profiles at the same time.

HEC-RAS Plan: Unsteady Inl Str River: Beaver Creek Reach: Kentwood											
Reach	River Sta	Profile	E.G. Elev (ft)	W.S. Elev (ft)	Q Total (cfs)	Q Weir (cfs)	Q Gates (cfs)	Q Culv (cfs)	Q Inline RC (cfs)	Q Outlet TS (cfs)	Q Breach (cfs)
Kentwood	5.26	Max WS	216.84	216.74	19948.83	18883.73	291.34	372.17	400.00	0.00	
Kentwood	5.26	09FEB1999 2400	211.73	211.67	2484.68	2260.86	67.45	73.59	82.99	0.00	
Kentwood	5.26	10FEB1999 0100	211.76	211.70	2559.31	2329.51	69.47	75.98	84.65	0.00	
Kentwood	5.26	10FEB1999 0200	211.85	211.78	2745.87	2500.89	74.60	82.05	88.69	0.00	
Kentwood	5.26	10FEB1999 0300	211.97	211.90	3017.23	2749.69	82.25	91.16	94.45	0.00	
Kentwood	5.26	10FEB1999 0400	212.13	212.05	3370.38	3073.84	92.36	102.61	101.64	0.00	
Kentwood	5.26	10FEB1999 0500	212.31	212.22	3800.95	3470.74	104.55	115.68	110.44	0.00	
Kentwood	5.26	10FEB1999 0600	212.49	212.37	4326.26	3818.21	116.50	123.72	117.80	150.00	
Kentwood	5.26	10FEB1999 0700	212.72	212.59	4902.70	4346.78	133.08	144.45	128.84	150.00	
Kentwood	5.26	10FEB1999 0800	212.97	212.83	5549.26	4945.61	151.36	162.58	140.44	150.00	
Kentwood	5.26	10FEB1999 0900	213.26	213.10	6241.68	5577.84	174.27	185.64	154.07	150.00	
Kentwood	5.26	10FEB1999 1000	213.54	213.37	6928.78	6209.70	195.80	207.09	167.32	150.00	
Kentwood	5.26	10FEB1999 1100	213.83	213.63	7714.03	6933.64	220.17	230.43	180.60	150.00	
Kentwood	5.26	10FEB1999 1200	214.11	213.90	8537.19	7715.89	246.70	230.06	193.30	150.00	
Kentwood	5.26	10FEB1999 1300	214.39	214.16	9393.37	8516.18	272.11	241.24	212.76	150.00	
Kentwood	5.26	10FEB1999 1400	214.66	214.41	10264.79	9321.39	296.99	258.05	237.52	150.00	
Kentwood	5.26	10FEB1999 1500	214.93	214.66	11209.11	10132.17	321.94	272.79	262.73	220.00	
Kentwood	5.26	10FEB1999 1600	215.18	214.88	12074.47	10953.58	332.18	284.21	284.95	220.00	

Energy gradeline for given WSEL.

Figure 18-18. Inline Structure Profile Table

## Summary

This example computed an unsteady flow event through a complex inline structure on Beaver Creek, which included an inline weir, culverts, gated spillway, outlet rating curve, and a time series outlet. The example demonstrated how to make use of the various inline features noted above.

In addition, a brief overview was given on the output profiles and tables that can be utilized in evaluating the operation of the inline structure. The output tables and profiles described were the **Inline Structure Output** table, **Profile Summary Output Table - Inline Structure**, and **Profile Plot**.





## CHAPTER 19

# Hydrologic Unsteady Routing – Modified Puls

### Purpose

This example will demonstrate the use of hydrologic unsteady routing in a HEC-RAS unsteady flow model. Modified Puls is the routing technique used to convey and attenuate the hydrograph downstream. This option is very useful when encountering portions of the model that are very steep and full unsteady flow routing is either unstable or not possible at all. A hydrologic routing reach can be an upstream piece, downstream piece, or an intermediate piece of any existing HEC-RAS unsteady flow river reach. It can also encompass an entire HEC-RAS river reach. When ran, the analyzer calculates and displays the hydrologic routing and unsteady flow portion of the reach simultaneously and seamlessly in one file. The modeler is referred to Chapter 6 of the User's Manual for a more detailed discussion on hydrologic unsteady routing.

To review the data files for this example, from the main HEC-RAS window, select **File** and then **Open Project**. Go to the directory in which you have installed the HEC-RAS example data sets. From the "**Applications Guide\Chapter 19 – Hydrologic Routing - ModPuls**" subdirectory, select the project labeled "**ModPulsRouting**." This will open the project and activate the following files:

Plan:	"Modified Puls Upstream Run"
Geometry:	"Existing Conditions – Modified Puls Upst"
Flow:	"Flow Hydrograph No Dam"

### Geometric Data

To view the geometric data for the river system, from the main program window select **Edit** and then **Geometric Data**. This will activate the **Geometric Data Editor** and display the river system schematic as shown in Figure 19.1. The schematic displays the 177 river stations of the reach "Loc Hav" on "Bald Eagle" river, with river station 138154.4 as the upstream cross section and 659.942 as the downstream cross section. Information on entering and editing geometric data can be found in preceding examples as well as Chapter 6 of the User's Manual.

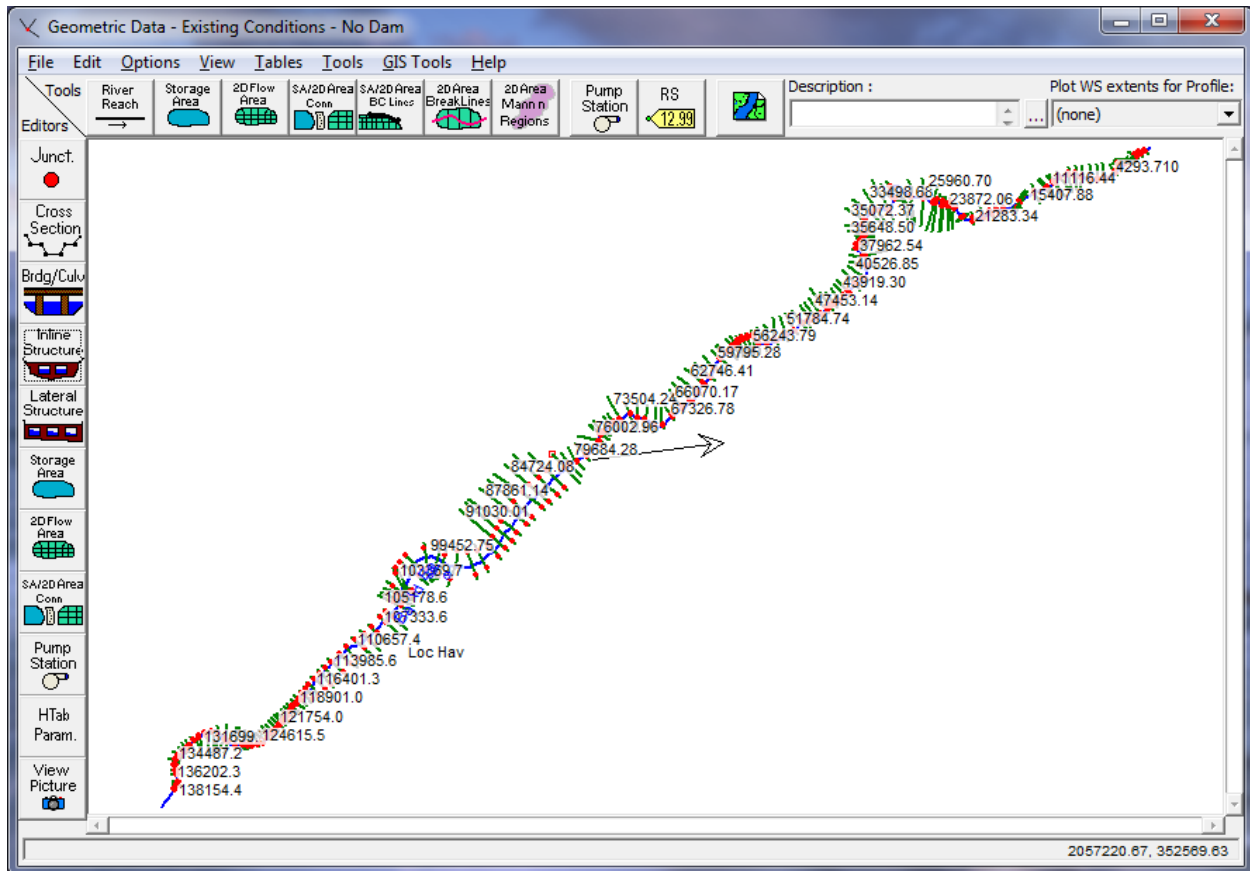

Figure 19-1. River System Schematic for Bald Eagle River

## Unsteady Flow Data

The user is required to enter boundary conditions and initial conditions for the system at the beginning of the simulation period. For additional information on unsteady flow data refer to Chapter 8 of the User's Manual, Performing an Unsteady Flow Analysis. The **Unsteady Flow Data Editor**, shown in Figure 19.2, was selected from the main program window under the **Edit** menu.

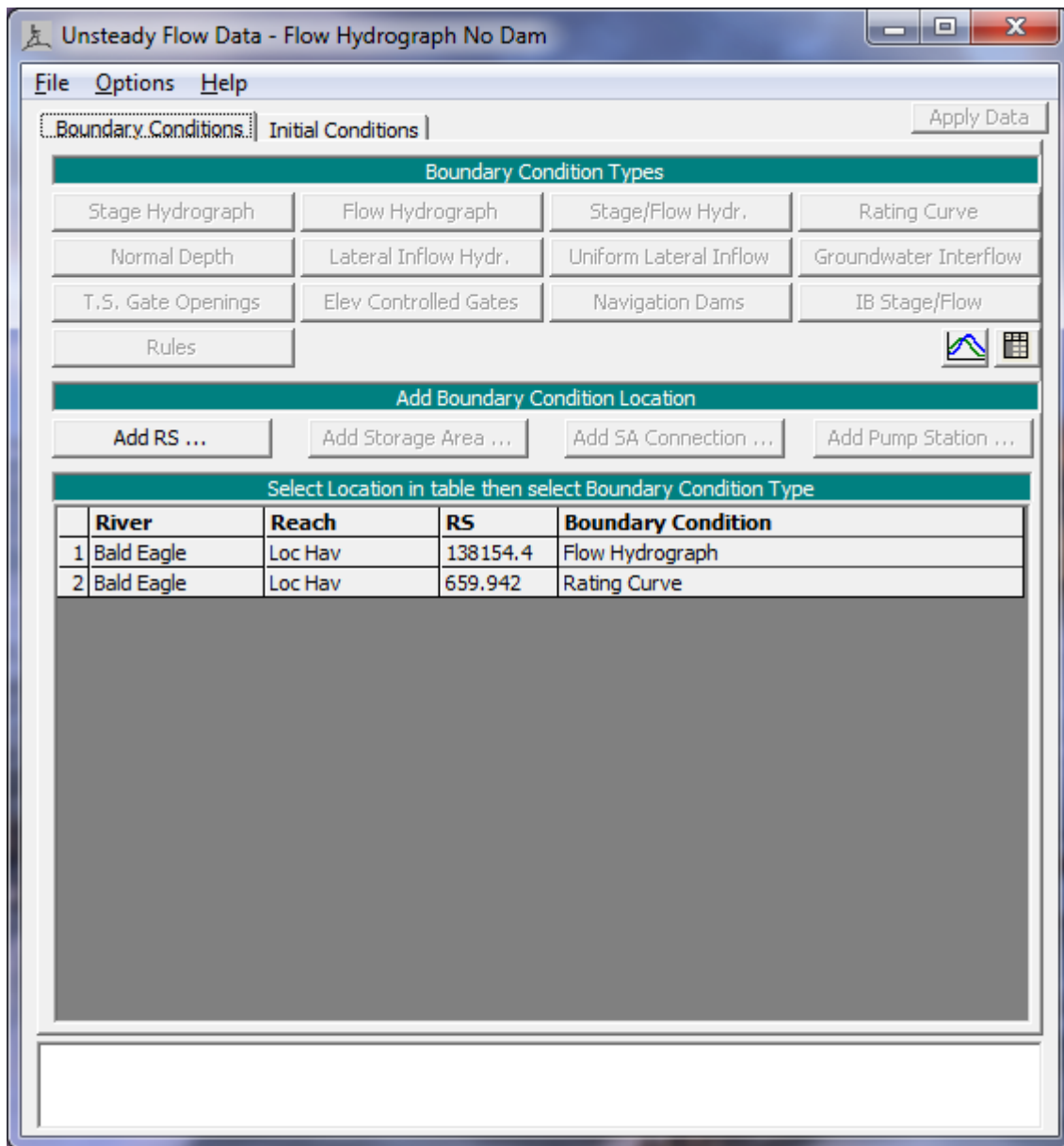

Figure 19-2. Unsteady Flow Data Editor

## Boundary Conditions

Boundary conditions are required for the farthest upstream and downstream cross sections. Upon entering the **Unsteady Flow Data Editor** the farthest upstream and downstream cross sections will be located in the boundary conditions column. In this case, the user will see River Station 138154.4 and River Station 659.942 as the upstream and downstream boundary conditions, respectively. Boundary conditions are set by highlighting the adjacent cell

under **Boundary Condition Type**. When a cell is highlighted, not all boundary conditions are available. The program will automatically gray out all irrelevant boundary condition types. Internal boundary conditions may be added by selecting one of the buttons under the “Add Boundary Condition Location” heading.

### **Upstream Boundary Condition**

For River Station 138154.4 a flow hydrograph was selected by highlighting the cell and pressing the **Flow Hydrograph** button. The window where the **Flow Hydrograph** is entered is shown in Figure 19.3. The user may select to read hydrograph data from a DSS file or manually enter the data. For further instruction on using a DSS file see *Unsteady Flow Application Example 17*. For this example the flow hydrograph was manually entered by selecting the **Enter Table** radio button. The **Data Time Interval** was set to one hour and the radio button **Use Simulation Time** was selected causing the initial propagation of the hydrograph to coincide with the beginning of the simulation time window. The hydrograph was then manually entered into the table.

**Flow Hydrograph**

River: Bald Eagle Reach: Loc Hav RS: 138154.4

Read from DSS before simulation Select DSS file and Path

File:

Path:

Enter Table Data time interval: 1 Hour

Select/Enter the Data's Starting Time Reference

Use Simulation Time: Date: 18FEB1999 Time: 0000

Fixed Start Time: Date:  Time:

No. Ordinates

Hydrograph Data			
	Date	Simulation Time	Flow
		(hours)	(cfs)
1	17Feb 1999 2400	00:00	1075.53
2	18Feb 1999 0100	01:00	1301.64
3	18Feb 1999 0200	02:00	1676.94
4	18Feb 1999 0300	03:00	2199.12
5	18Feb 1999 0400	04:00	2864.95
6	18Feb 1999 0500	05:00	3670.34

Time Step Adjustment Options ("Critical" boundary conditions)

Monitor this hydrograph for adjustments to computational time step

Max Change in Flow (without changing time step):

Min Flow:  Multiplier:

Figure 19-3. Flow Hydrograph for Upstream Boundary Condition

### Downstream Boundary Condition

For River Station 659.942 the boundary condition selected was a rating curve. Again, the corresponding cell for that particular river station was highlighted and the **Rating Curve** button was selected. The window shown in Figure 19.4 is then displayed and the user is given a choice whether to *Read from DSS before simulation* or *Enter Table*. For this example the **Enter Table** radio button was selected and the stage and flow values were entered in the appropriate units.

River: Bald Eagle Reach: Loc Hav RS: 659.942

Read from DSS before simulation Select DSS file and Path

File:

Path:

Enter Table

Del Row    Ins Row

Hydrograph Data		
	Stage (ft)	Flow (cfs)
1	529.2	0.
2	535.	1000.
3	540.	3000.
4	557.3	16500.
5	562.1	27000.
6	564.1	32500.
7	568.6	47000.
8		
9		
10		
11		

Plot Data    OK    Cancel

Figure 19-4. Rating Curve for Downstream Boundary

### Initial Conditions

Initial conditions consist of flow information at each of the specified cross sections, as well as elevations for any storage areas defined in the system. Data for initial conditions is established by selecting the **Initial Conditions** tab on the **Unsteady Flow Data Editor**. After selecting the tab, Figure 19.5 will be displayed.

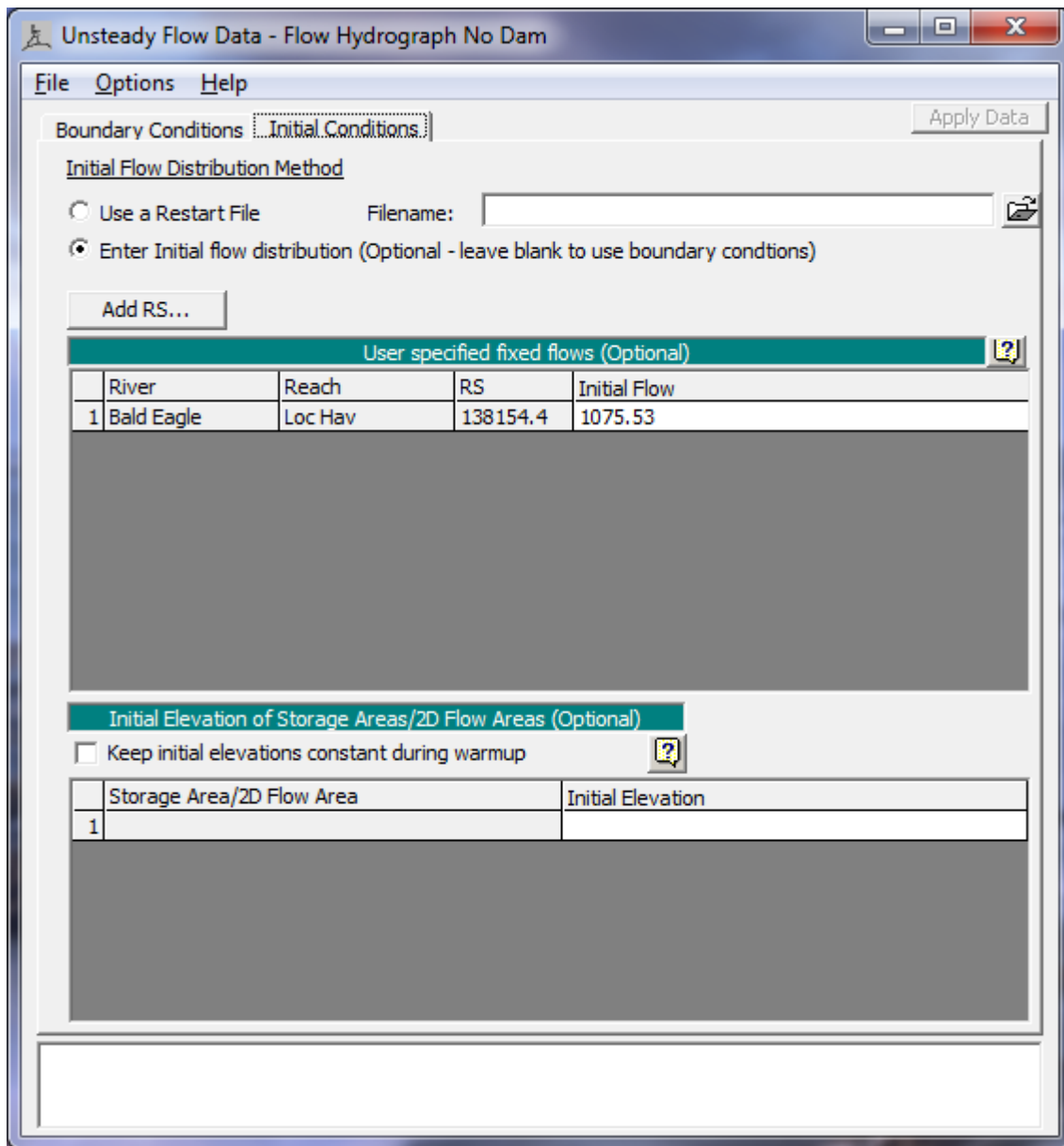

Figure 19-5. Unsteady Flow Data Initial Conditions

As seen in Figure 19.5, the **Enter Initial flow distribution** radio button was selected and an initial flow of 1075.53 was entered for the most upstream river station (138154.4). The data was then saved (**File -> Save Unsteady Flow Data As**) in the **Unsteady Flow Data Editor** and the window was closed.

## Steady Flow Analysis

### Purpose

Although the Modified Puls routing method is only used for unsteady flow, a steady flow dataset and analysis must be completed first. The purpose of the steady flow plan is to compute a range of water surface profiles that encompasses all expected flow rates of the unsteady model. The results from the steady flow run are used within the hydrologic routing reaches in order to provide the necessary discharge-volume relationships required by Modified Puls routing.

### Steady Flow Data

To enter the flow data, from the main program window **Edit** and then **Steady Flow Data** were selected. This activated the **Steady Flow Data Editor** as shown in Figure 19.6. For this example, 30 flow profiles were computed ranging from a low flow of 1,000 cfs to a high flow of 60,000 cfs. A value of "30" was entered as the number of profiles and the central table of the editor established thirty columns for the flow profiles. The flow values were then entered at the upstream river station (138154.4) with values incrementally increasing by 2,000 cfs for each profile (with the exception of the last profile, which increases by 5,000 cfs).

The wide range of steady flow rates extends below the minimum (1,075.53 cfs) and beyond the maximum (50,000 cfs) flows within the unsteady flow hydrograph. If an unsteady flow rate is not encompassed within the range of the steady flow profiles, the model will calculate its corresponding stage by linearly extending the two nearest points on the rating curve and interpolating the stage value from the given unsteady flow value. Since the rating curve relationship of stage and flow is typically not linear, this interpolation is not recommended. Therefore, it is advised that the user uses a wide enough range of steady flow profiles so that all unsteady flows are included. Furthermore, a large number of water surface profiles (20 or more) are advised in order to get good definition in the rating curves.



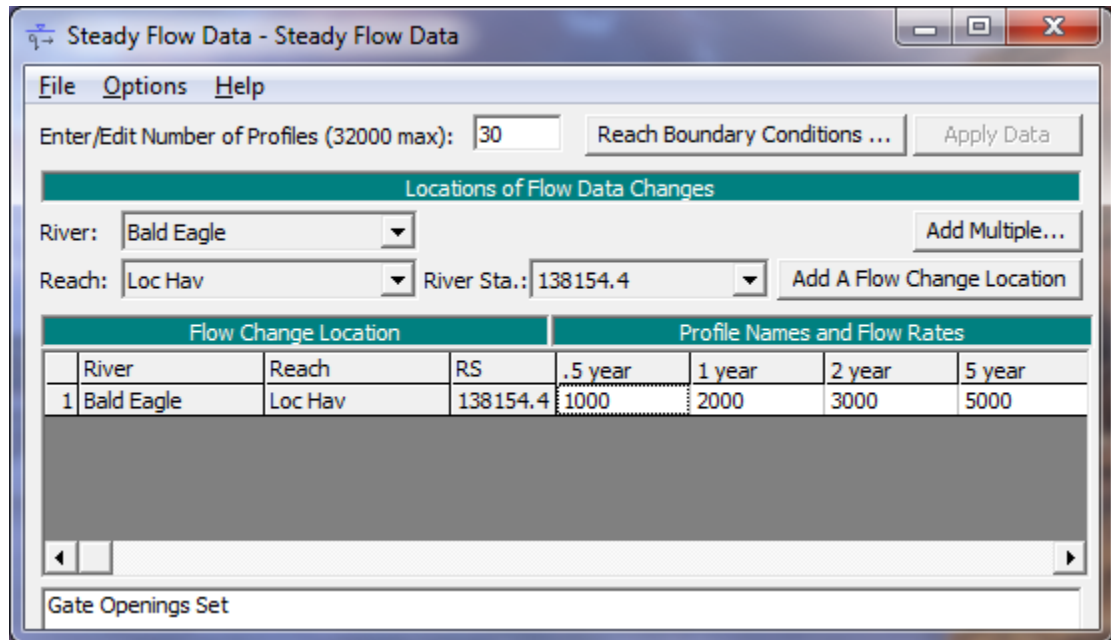

Figure 19-6. Steady Flow Data Editor

## Boundary Conditions

To enter the boundary conditions the **Boundary Conditions** button at the top of the **Steady Flow Data Editor** was selected. This activated the **Boundary Conditions Editor** as shown in Figure 19.7. This flow analysis was performed in the subcritical flow regime. Therefore, a boundary condition was established at the downstream end of the reach for each flow profile. For a detailed discussion on the boundary conditions, the modeler is referred to Chapter 7 of the **User's Manual** and Chapter 3 of the **Hydraulic Reference Manual**. From the Boundary Conditions Data Editor, the boundary conditions were entered by first selecting the *Downstream* field and then **Rating Curve**. This activated a table where stage and flow information were entered as shown in Figure 19.8. Once the data were entered, the **OK** button was selected to exit this window. This completed the necessary steady flow data for the analysis and the data were saved as "Steady Flow Data."

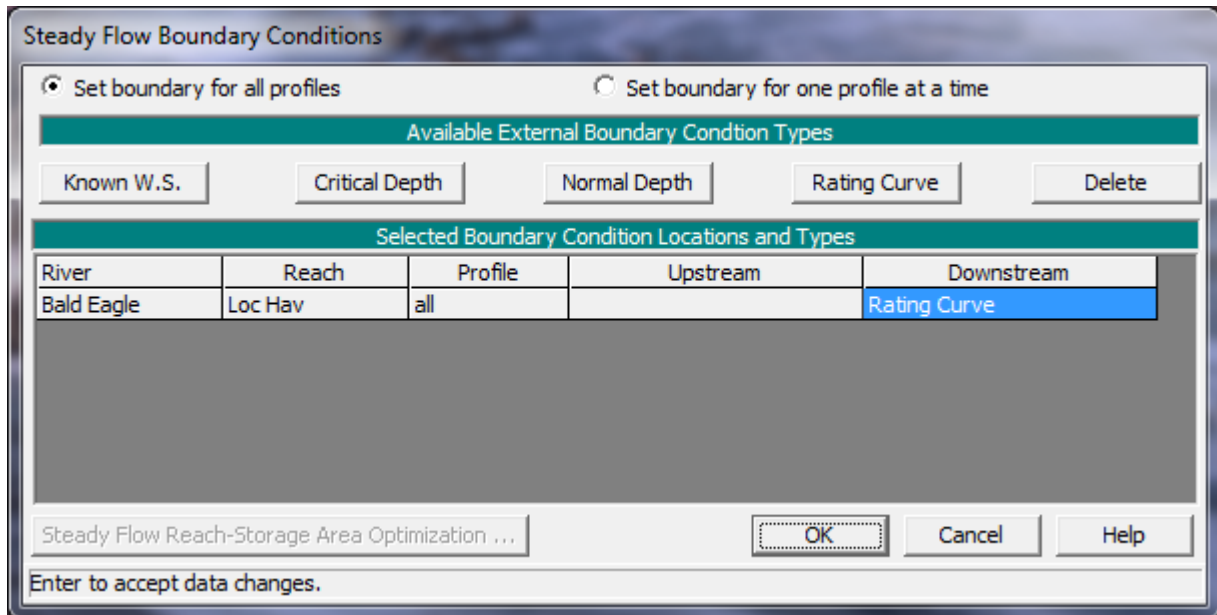

Figure 19-7. Boundary Conditions Data Editor

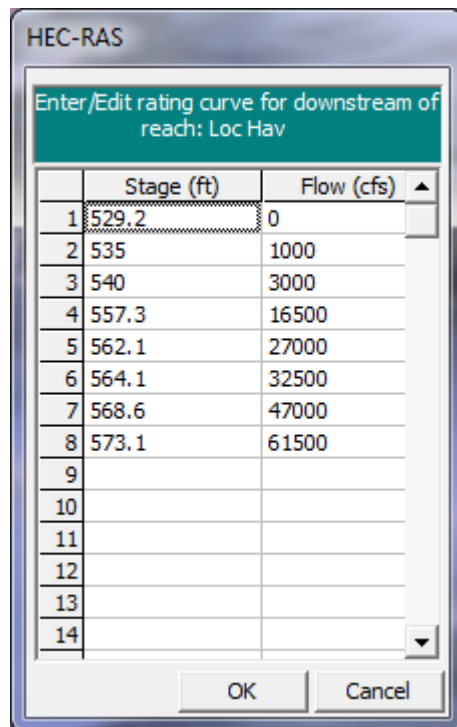

Figure 19-8. Rating Curve for Downstream Steady Flow Boundary Condition

## Steady Flow Computations

To perform the steady flow analysis, from the main program window **Run** and then **Steady Flow Analysis** were selected. This activated the **Steady Flow Analysis Window** as shown in Figure 19.9. A **Short ID** was entered as "SteadyNoDam" and a subcritical flow analysis was selected in the lower left corner of the editor. The geometry file "Existing Conditions – Modified Puls Upst" and the steady flow file "Steady Flow Data" were saved as the plan "Steady Flow No Dam". A steady flow plan must be run using the exact same geometry file to be used for the unsteady flow modeling.

After all the necessary data was entered, the **Compute** button was selected to perform the steady flow analysis.

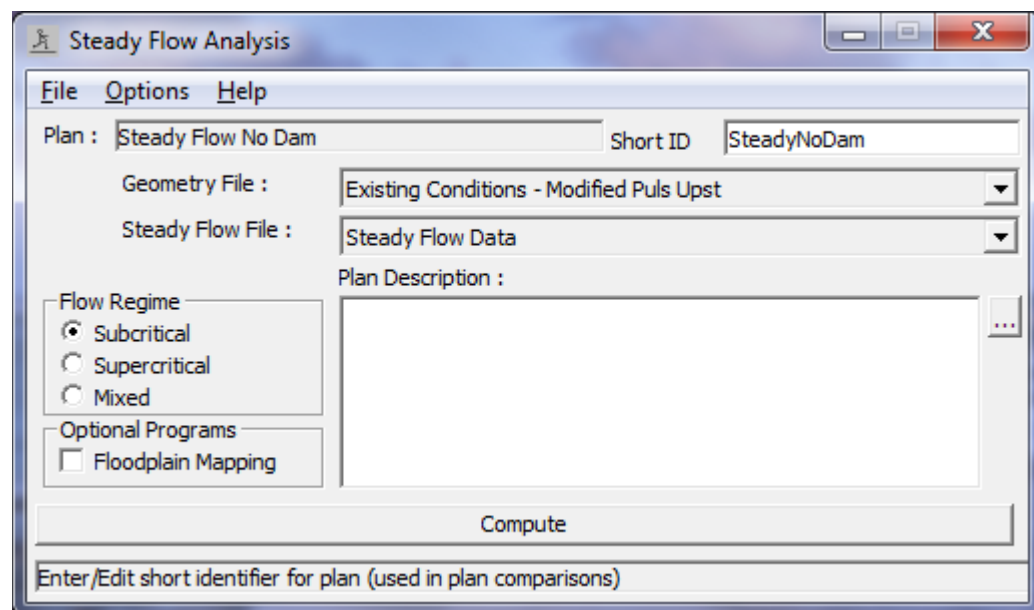

Figure 19-9: Steady Flow Analysis Window

## Hydrologic Unsteady Routing

The **Modified Puls Hydrologic Routing** editor is opened by selecting **Options** and then **Hydrologic Unsteady Routing** from the **Geometric Data Editor**. Once the Modified Puls window is displayed (Figure 19.10), the **Use Modified Puls Routing** box was checked on. If the *Use Modified Puls Routing* box is not checked, the Modified Puls routing option will be ignored, and HEC-RAS will perform full unsteady flow routing at all of the cross sections. However, when checked, Modified Puls routing will be performed on the specified cross sections when an unsteady flow analysis is run (it is ignored for steady flow runs).

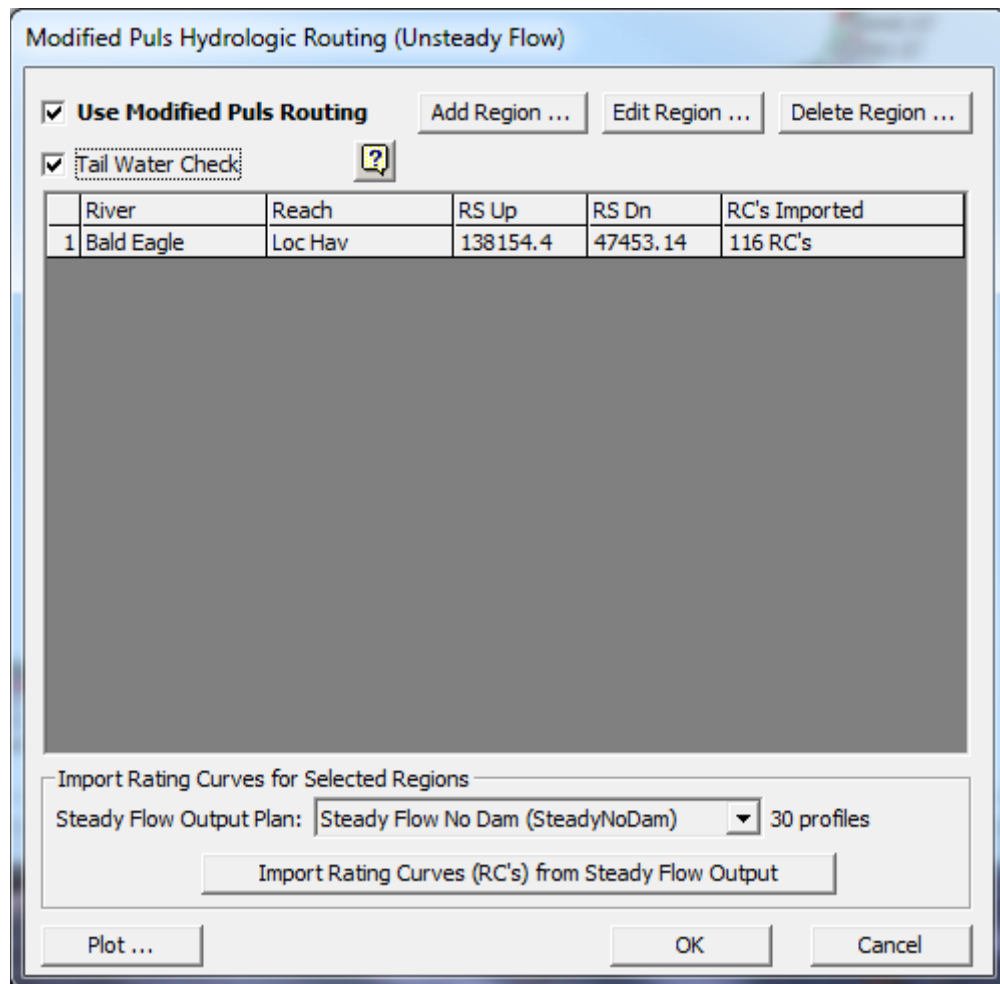

Figure 19-10. Hydrologic Unsteady Flow Routing Editor

The cross sections for which Modified Puls routing was to be performed were selected by clicking the button **Add Region** and then choosing the upstream and downstream bounds of the river and reach which the routing was to be carried out (see Figure 19.11). Once the desired region was selected, **OK** was clicked. The region selected was automatically populated in the Modified Puls Hydrologic Routing table as seen in Figure 19.10.

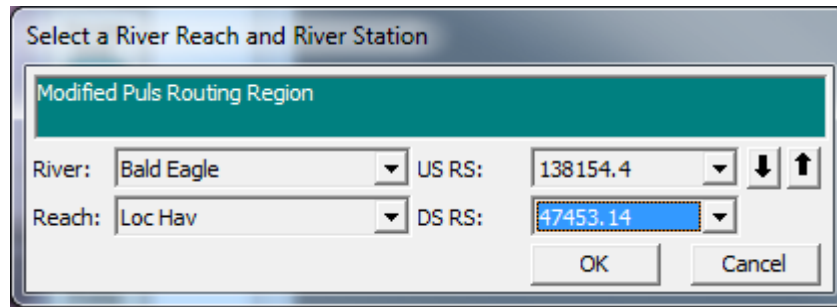

Figure 19-11. Hydrologic Routing Region Selection Window

In order to populate the last column (*RC's Imported*), rating curves needed to be imported for the selected region. Below the table there is an area titled **Import Rating Curves for Selected Regions** where a list of steady flow output plans can be selected from a drop down menu. For this example, "SteadyNoDam" was selected and the number of profiles within the plan (30) was listed next to the drop down menu (see Figure 19.10). Next, the blank cell under the column heading *RC's Import* was selected. Then, **Import Rating Curves (RC's) from Steady Flow Output** was clicked and rating curves from the steady flow output were imported for all 116 cross sections within the designated region. The imported rating curves can be visually inspected by clicking **Plot** in the lower left hand corner of the window. ***It should be noted that the steady flow models should have been run previous to this step and that the same geometry file must be used.***

Before clicking OK and exiting the window, the box corresponding to **Tail Water Check** was checked on. When turned on, this option will monitor the downstream interface of any hydrologic routing reach to verify that the next cross section downstream has a lower computed water surface elevation than the last section of the hydrologic routing reach. If it does have a lower computed water surface elevation then the results are accepted and displayed. However, if the downstream water surface (tailwater) is higher than the water surface of the last cross of the hydrologic routing reach, then the tailwater is forced into the downstream portion of the hydrologic routing reach. When run, the model will continue to overwrite the hydrologic routing cross sections' computed water surface elevations until a cross section is reached where the hydrologic routing computed water surface elevation is higher than the tailwater elevation.

Below are the water surface profiles from a similar geometry file as used in this example where the **Tail Water Check** was not used (Figure 19.12) and where it was (Figure 19.13). There is an inline structure in the middle of the reach that is causing a backwater effect upstream of the structure. As seen in the figure below, this backwater effect is only illustrated in the portion of the reach that is modeled as unsteady flow, while the portion modeled with Modified Puls does not consider the backwater effects of the inline structure, which causes the huge stage difference seen in Figure 19.12. By turning on the Tail Water Check, this unrealistic water surface profile is corrected by

propagating the backwater effect upstream into the reach region that was modeled with Modified Puls routing.

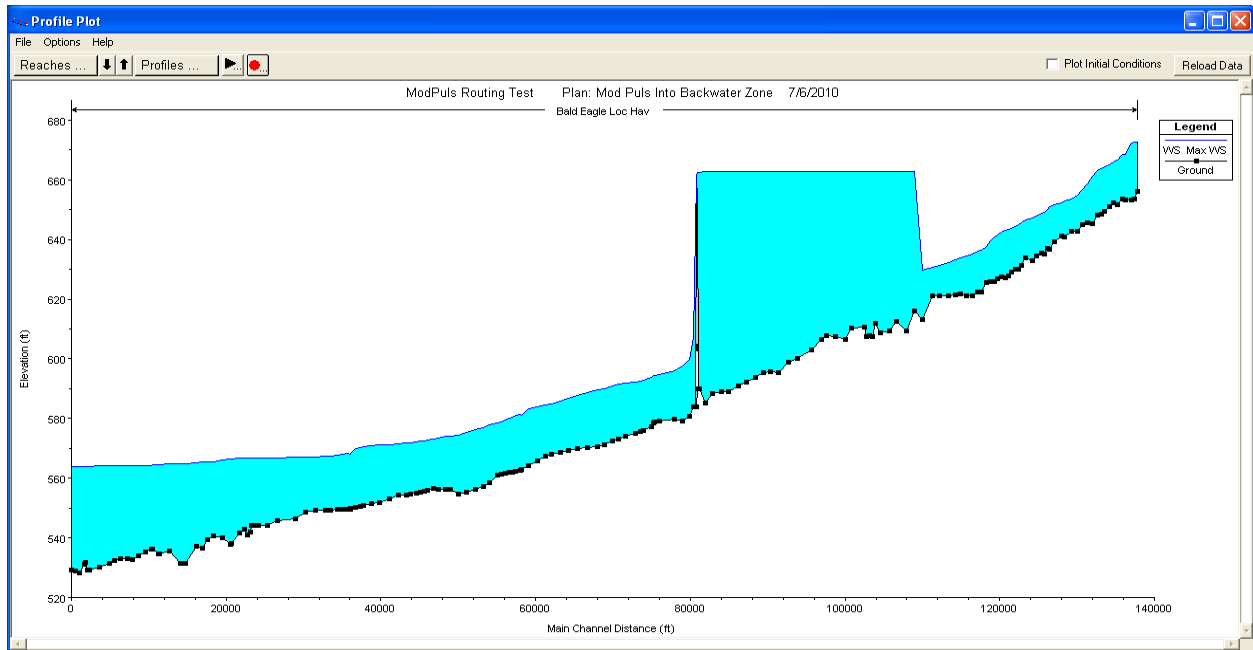

Figure 19-12. Profile Plot of transition between unsteady routing and Modified Puls routing with Tail Water Check NOT turned on.

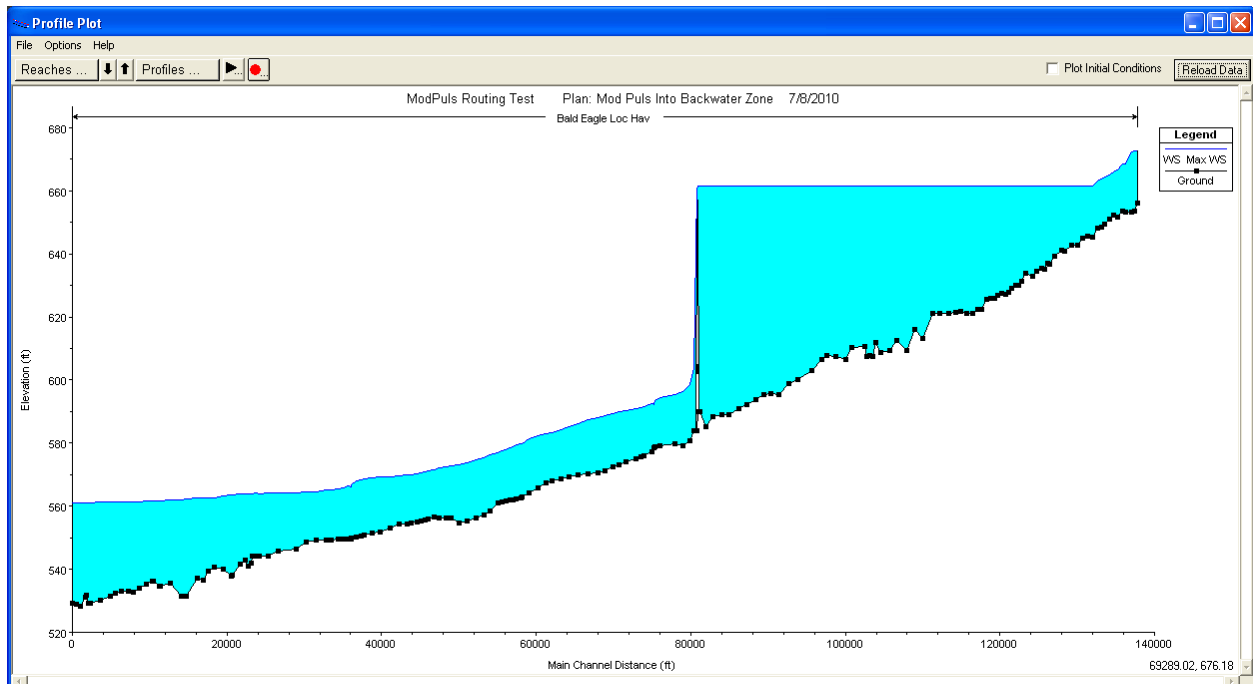

Figure 19-13. Profile Plot of transition between unsteady routing and Modified Puls routing with Tail Water Check turned on.

The Tail Water Check allows for downstream conditions to influence the water surface, volume, and flow rate in the hydrologic routing reach. Although the Tail Water Check function may give a more realistic result, it may also increase instability. It should also be noted that there must be at least one or two normal cross sections between the end of the reach and the Modified Puls region; if there isn't then the tailwater check will be ignored. For this specific example, the Tailwater check option was not used, because there were no downstream structures that will cause a backwater upstream in this example.

## Unsteady Flow Analysis

After completing the preceding steps an unsteady flow analysis may be initiated. Under the main program window **Unsteady Flow Analysis** was selected under the **Run** menu. This will display the **Unsteady Flow Analysis Window** shown in Figure 19.14. A plan was defined by selecting the Geometry File "Existing Conditions – Modified Puls Upst" and the Unsteady Flow File "Unsteady Flow." Under the **File** menu, **Save Plan As** was selected and the plan title was entered as "Flow Hydrograph No Dam." After entering the title of the plan a short identifier was entered as "ModPulsUpStream" and the plan was saved.

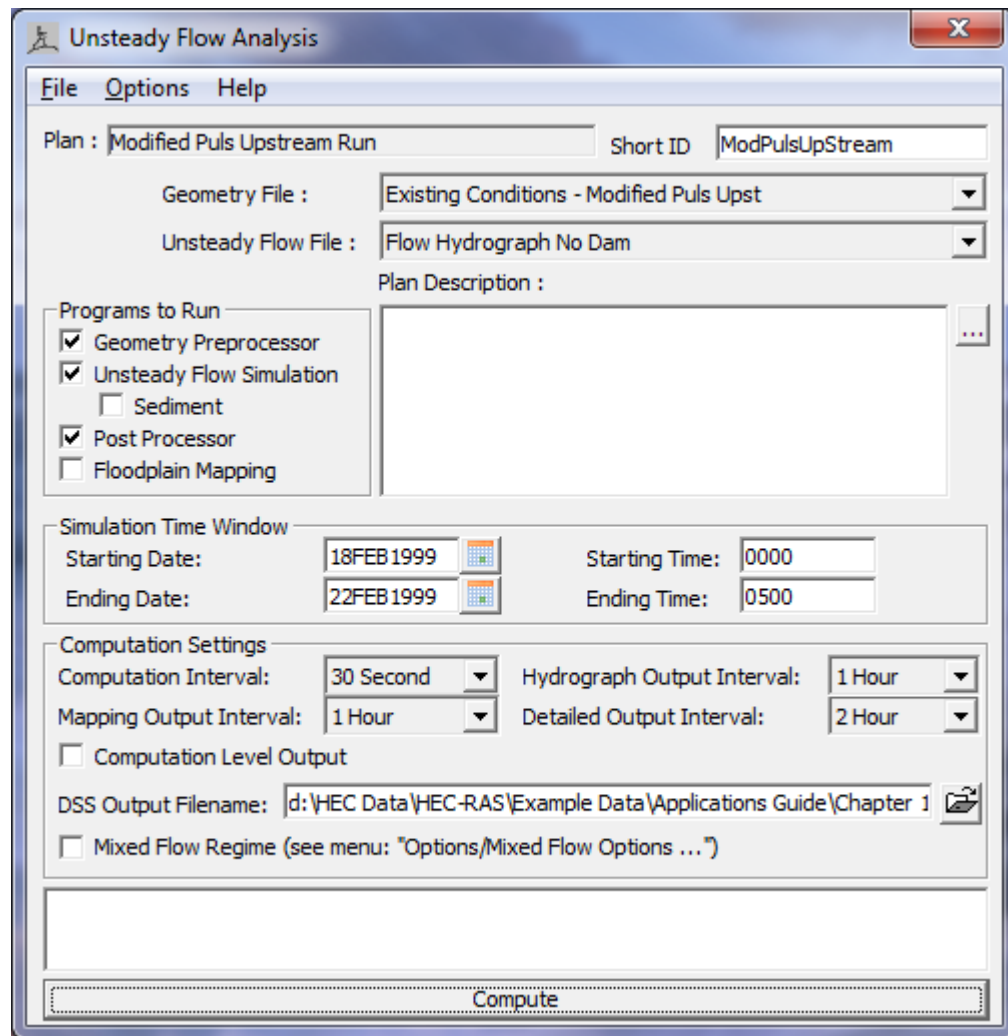

Figure 19-14. Unsteady Flow Analysis Window

## Simulation Time Window

The simulation time window, located on Figure 19.14, requires a beginning and ending date and time for simulation. The date must have a four digit year and can be entered in the following format: 18FEB1999. The time field is entered in military time (i.e. 1 p.m. is entered as 1300). For this application the simulation time began and ended at 0000.

## Computation Settings

The computation settings in the **Unsteady Flow Analysis Window** contain the following: the computational interval; hydrograph output interval; instantaneous profiles interval; and the name and path of the output DSS file.



For this example the computation interval was set to 30 seconds. In order to ensure stability and accuracy, the Courant condition was used to determine the computation interval (see Chapter 8 of User's Manual for more detail). The hydrograph output interval was set to 1 hour. This interval defines the output of computed stage and flow hydrographs written to HEC-DSS. The detailed output interval was set to 2 hours, specifying the interval at which detailed hydraulic output will be computed by the post processor. It is suggested that this interval remain fairly large to reduce the amount of post processing and storage required.

## Programs to Run

There are three components used in performing an unsteady flow analysis within HEC-RAS: the geometric data preprocessor (HTAB); the unsteady flow simulator (UNET); and an output post processor. These three (plus Floodplain Mapping, which is not discussed in this application) can be found and turned on under the **Programs to Run** heading found on the Unsteady Flow Analysis window (see Figure 19.14).

The geometry pre-processor is used to speed up the unsteady flow calculations by processing the geometric data into a series of hydraulic property tables and rating curves. It is highly recommended that the user run the geometry pre-processor and examine hydraulic output for anomalies before running the unsteady flow simulator and the post-processor.

The unsteady flow simulation is what actually creates the stage and flow hydrographs. The program is a three step process that requires the tables from the geometry pre-processor, the boundary conditions, and flow data from the interface to operate.

The post processor is used to compute detailed hydraulic information for a set of user specified time lines during the unsteady flow simulation period. By running the post processor, the user will have all of the available plots and tables for unsteady flow that HEC-RAS normally produces for steady flow.

The **Geometry Preprocessor**, **Unsteady Flow Simulation**, and **Post Processor** were all checked on.

## Location of Stage and Flow Hydrographs

The user has the option of specifying locations for which hydrographs will be computed and available for display. For this example the stage and outflow hydrographs were calculated for every cross section by clicking on **Options** then **Stage and Flow Output Locations** from the **Unsteady Flow Analysis** toolbar. A window opened and all 177 cross sections were selected by highlighting **(All RS)** and clicking the arrow to bring them over to the *Selected Locations* portion of the window. After selecting the cross section locations, **OK** was pressed.

## Output Analysis

For the analysis of the output, the water surface profiles and the flow hydrographs will be reviewed. In addition, a comparison will be shown between this model run with full unsteady flow versus a combination of unsteady flow and hydrologic unsteady routing (as was used in this application). Each of these is discussed in the following sections.

### Water Surface Profiles

The water surface profiles are shown in Figure 19.15. This figure was activated from the main program window by selecting **View** and then **Water Surface Profiles**. The figure shows the maximum water surface elevation. The entire event can be seen as an animation by selecting **Options** and then **Animate** from the profile plot window. As seen in the figure below, there is a smooth transition between the reach's upstream portion that was modeled with Modified Puls and the downstream portion that was modeled with the unsteady flow equations. If there were not a smooth transition (such as in Figure 19.12) the model would need to be reexamined to determine the cause. A good place to start is by evaluating the stage and flow hydrographs.

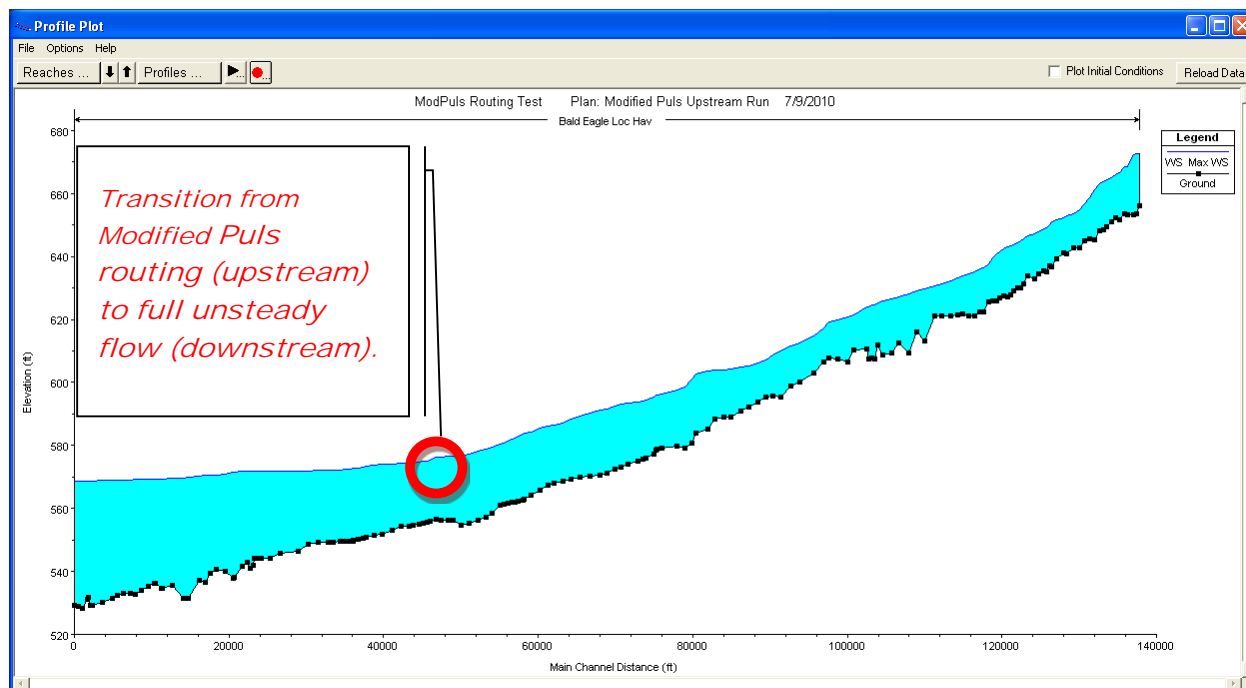

Figure 19-15. Water Surface Profile for Bald Eagle River

## Stage and Flow Hydrographs

The Stage and Flow Hydrographs can be viewed from the main program window by selecting **View** and then **Stage and Flow Hydrographs**. There are three different ways to view the stage and flow data: *Stage Flow*, *Table*, and *Rating Curve*. These viewing options can be selected from three separate tabs found above the output viewing window. Interpreting the stage and flow hydrographs is further discussed further in Chapter 9 of the User's Manual.

## Full Unsteady Flow and Hydrologic Unsteady Routing Comparison

The Bald Eagle River modeled in this example application could actually be modeled entirely with the unsteady flow equations without going unstable. However, a portion of the river was modeled using the Modified Puls routing method so that the user could better understand how to utilize the feature. In order to convey the precision of the two methods (Modified Puls routing and the unsteady flow equations), they are compared here.

The discrepancy in water surface elevations between the two methods is negligible for this example – most cross-sections show a difference within a couple of inches or less. Figure 19-16 shows the close proximity of the maximum water surface profiles of the Modified Puls run (straight blue line) and the full unsteady run (blue line with triangles). Yet, there are some instances such as during low flows or when channel contraction occurs near a bridge when there are larger discrepancies. These differences are primarily because the hydrologic modeling method doesn't completely capture the hydrodynamics associated with the changes in flow rate like the unsteady flow equations do.

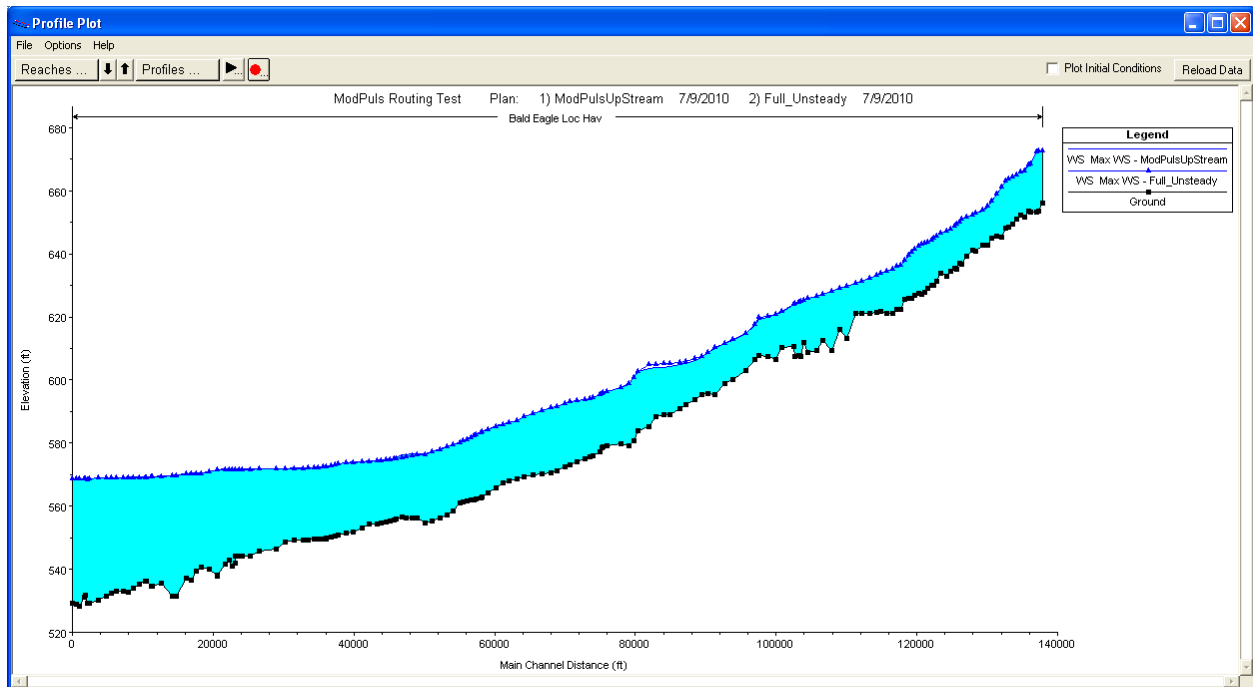

Figure 19-16. Comparison of Profile Plots: Full Unsteady Flow and Hydrologic Routing Method

## Summary

The Hydrologic Unsteady Routing option is very useful when encountering portions of the model that are very steep and full unsteady flow routing is either unstable or not possible at all. To perform the analysis the user must enter the geometric data for the river reach. Within the Geometric Data Editor the hydrologic unsteady routing parameters are entered. A steady flow model must be created using the exact same geometry file to be used for the unsteady flow modeling and should include a set of profiles that includes all possible flows within the unsteady flow model. The rating curves from the steady flow output are imported into the Modified Puls Hydrologic Routing Editor so that stages and flows can be interpolated when it is evaluated in the Unsteady Flow Analysis. Although unsteady modeling is more accurate than Modified Puls routing, there is typically very little variance between the results.

## CHAPTER 20

# Hager's Lateral Weir Equation

### Purpose

This example demonstrates how to model a lateral weir embankment using Hager's equation. Hager's equation is the same as the standard weir equation, except Hager's weir discharge coefficient is computed automatically based on physical and hydraulic properties. The primary and intended use of Hager's equation is for a designed lateral structure and channel, as often found in urban settings. Although using Hager's equation to model things such as a natural channel or a levee represented as a lateral weir is beyond the parameters of the equation, it can be done; however, the results should be examined with caution and discernment. The modeler is referred to Chapter 6 of the **User's Manual** for further discussion on entering the geometric data for a weir and Chapter 7 of the **Hydraulic Reference Manual** for a more in-depth look at weir properties and equations.

To review the data files for this example, from the main HEC-RAS window, select **File** and then **Open Project**. Go to the directory in which you have installed the HEC-RAS example data sets. From the "**Applications Guide\Chapter 20 - HagerLatWeir**" subdirectory, select the project labeled "**HagerLatWeir**." This will open the project and activate the following files:

Plan:	"Unsteady Sharp Crest S=10ft/mi"
Geometry:	"Rect chan S=10ft/mi Sharp Crested"
Flow:	"Hydrograph 8 to 17K"

### Geometric Data

To view the geometric data for the river system, from the main program window select **Edit** and then **Geometric Data**. This will activate the **Geometric Data Editor** and display the river system schematic as shown in Figure 20.1. The schematic displays the 21 river stations of "Brunner River," with river station 1000 as the upstream cross section and zero as the downstream cross section.

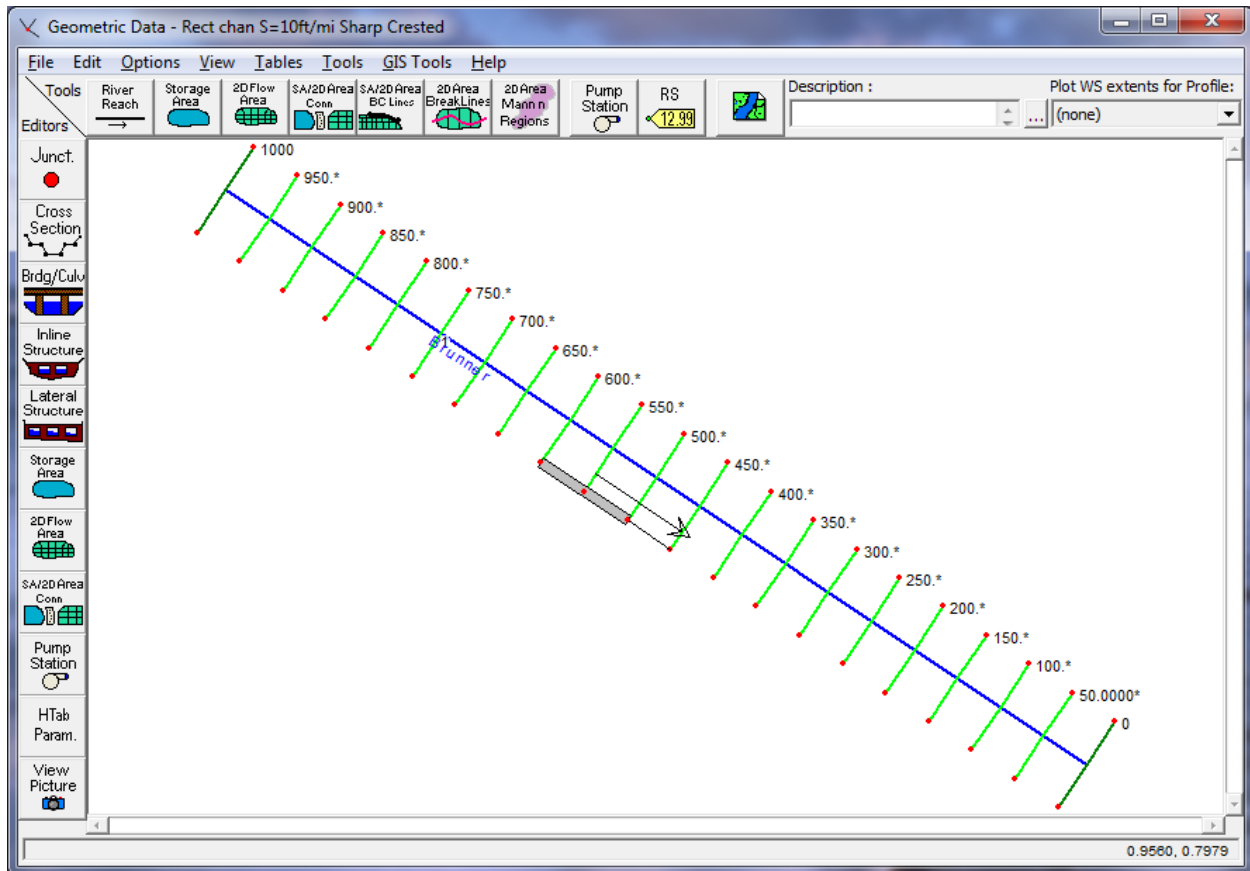

Figure 20-1. River System Schematic for Brunner River

### Cross Section Data

The cross section data consists of the X-Y coordinates, Manning's n values, contraction and expansion coefficients, etc. The user can view this data for each river station by selecting the **Cross Section** icon on the left side of the **Geometric Data Editor**. For this example, a lateral weir was added at river station 599 and will be discussed in the next section.

The upstream and downstream rectangular cross sections were manually entered while the 19 river stations in between were interpolated. Although Brunner River is fictional, it is supposed to emulate a simplistic version of a rectangular channel and designed lateral structure that is often found in urban settings. For more information on entering cross section data and interpolating cross sections look to "Example 1 Critical Creek" and Chapter 6 of the **User's Manual**.

## Lateral Structure

To add a lateral weir, the **Lateral Structure** icon was selected from the left side of the **Geometric Data Editor**. This activated the **Lateral Structure Editor** as shown in Figure 20.2. The river "Brunner" and the reach "1" should already be selected. Then, **Add a Lateral Structure** was selected from the **Options** menu, and river station 599 was entered as the location for the weir. By entering the river station, the upstream end of the lateral weir is automatically placed between the cross section with the next highest river station upstream and the next lowest river station downstream. The schematic will display a profile plot of the lateral weir and any gates. When the lateral weir is first added, the schematic will be blank because the data have not yet been entered. The modeler can choose to place the lateral weir in the right or left overbank, or the right or left side of the channel by choosing from the drop down menu titled **HW Position**. For this problem, the weir has been placed "Next to right bank station." The **Tailwater Connection** type was chosen as "Out of the system" because the diverted flow left the region of interest that the model captured. "No Flap Gates" and "Weir/Gates/Culverts/Diversion Rating Curves" were selected from **All Culverts** and **Structure Type**, respectively.

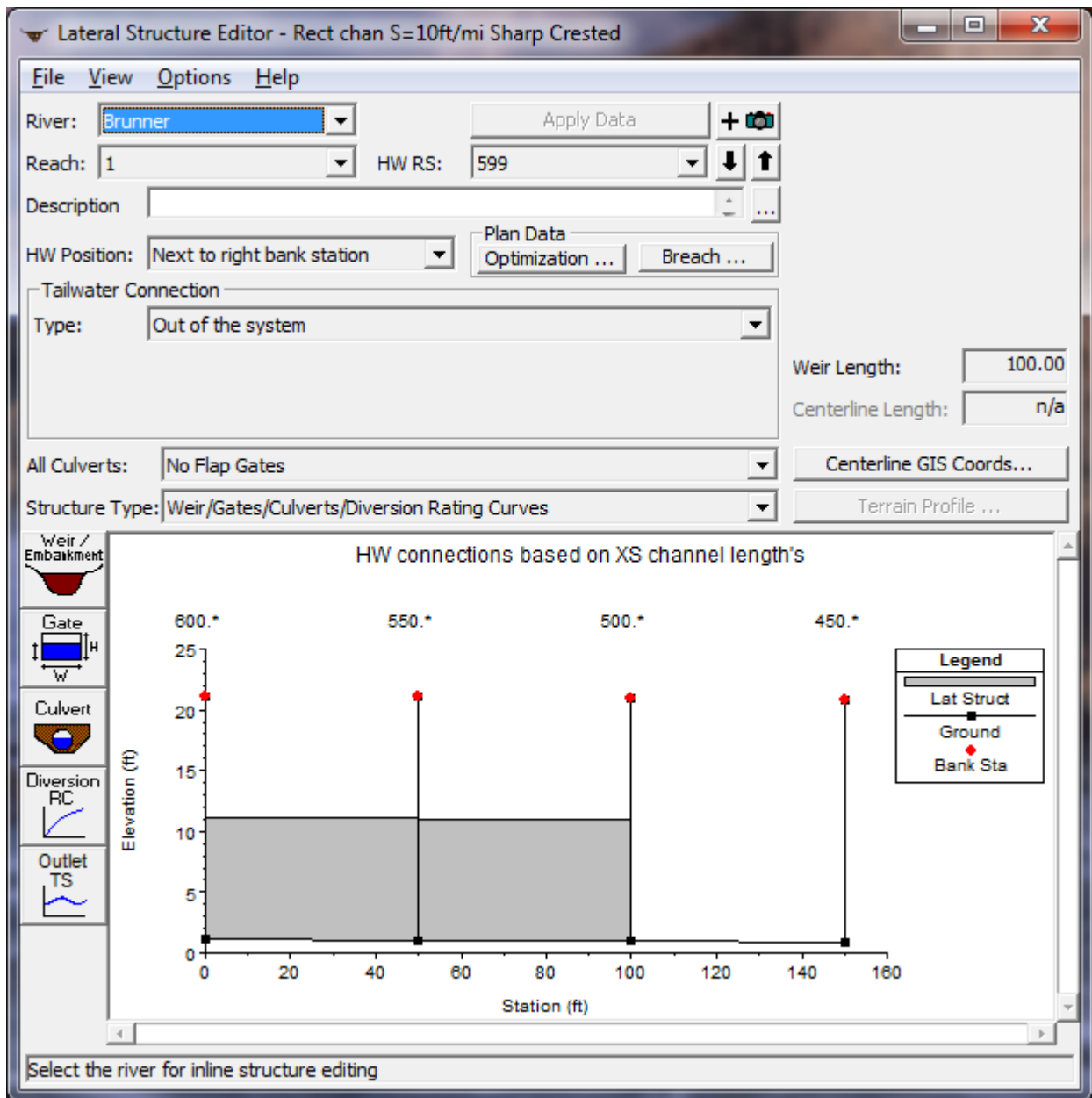

Figure 20-2. Lateral Weir Data Editor

### Lateral Weir Embankment – Hager’s Equation

To enter the data for the weir, the **Weir/Embankment** icon was selected from the left side of the **Lateral Weir Data Editor**. This activated the **Lateral Weir/Embankment Editor** as shown in Figure 20.3. This editor is somewhat similar to the deck/roadway editor used for bridges and culverts.



**Lateral Weir Embankment**

**Weir Data**

Weir Width: 10

Weir Computations: Hager's Eqn

**Hagers Weir Equation Parameters**

Default Weir Coefficient (Cd): 2.2

Weir Average Height: 10

Average Bed Slope: 0.00189

Weir Angle in Degrees (optional):

Weir Crest Shape: Sharp Crested

**Weir Stationing Reference**

HW Distance to Upstream XS: 0

HW Connections ... TW Connections ...

**Embankment Station/Elevation Table**

Weir Station and Elevation Filter...

	Station	Elevation
1	0.	11.13
2	100.	10.94
3		
4		
5		
6		
7		
8		
9		
10		
11		
12		
13		
14		
15		
16		
17		
18		
19		
20		
21		

OK Cancel

Figure 20-3. Lateral Weir/Embankment Editor

The left side of the editor has several fields and is where Hager's Weir Equation Parameters are entered. The first field is the *Weir Width*. This is width of the weir in the direction of flow over the weir (perpendicular to the flow in the river cross section). With the exception of calculating the broad crested weir coefficients with Hager's Equation, the weir width is not used for hydraulic computations, but is used by the GUI for graphical purposes. In this example, it has been set to 10 feet.

The next field is labeled *Weir Computations*. This field allows the user to select from two different equations to be used in computing the lateral weir flow: the Standard Weir Equation and Hager's Lateral Weir equation. *Hager's Eqn* was chosen.

There are four entries for the **Hager's Weir Equation Parameters** field: *Default Weir Coefficient (Cd)*, *Weir Average Height*, *Average Bed Slope*, and *Weir Angle in Degrees*. The default weir coefficient (Cd) is used for the first iteration of calculations when computing Hager's equation. Although the weir value initially entered for Hager's equation will not be exactly the same as the

final value used after the equation goes through the iterative process, it should represent a reasonable approximation. Typically, the default weir coefficient is lower than the prescribed coefficients for weirs of the same type. In this example, 2.2 is used for a sharp crested weir whereas the Hydraulic Reference Manual prescribes a weir coefficient of 3.1 – 3.3 for a sharp crested weir (Table 8-1 Typical Overflow Weir Coefficients). The coefficient is lowered because the weir equation assumes that the water flows perpendicular to the weir face, which is not the case for lateral weirs. Therefore, the coefficient is lower than normal to accurately account for the lower flows that will occur due to the variance in flow direction.

The *Weir Average Height* is the average height of the weir above the ground. The average height of the weir was 10 feet in this example.

The *Average Bed Slope* and *Weir Angle in Degrees* are both optional fields. If the user does not enter the average slope of the stream bed, then the program will compute the slope by estimating an average bed elevation for each cross section and then compute the slope from the average bed elevations. The *Weir Angle in Degrees* value is assumed to be zero (meaning the weir is parallel to the stream) if nothing is entered. If the weir is not parallel to the stream but instead angled towards the center of the river, an angle is required in the field (see Figure 20.4 to see how the angle is determined).

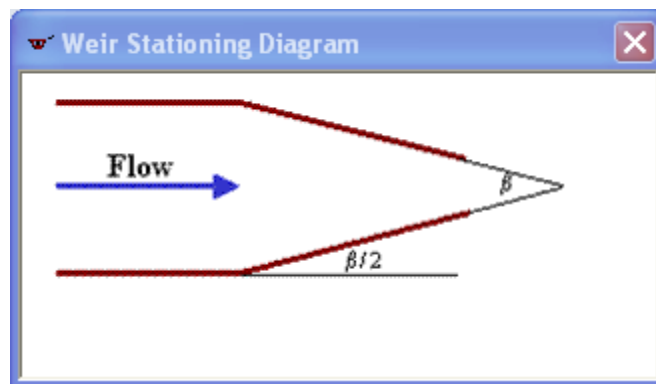

Figure 20-4. Weir Angle in Degrees Entry Diagram

The next field is *Weir Crest Shape*, and the user can select one of the following four shapes: *Broad Crested*; *Ogee*; *Sharp Crested*; or *Zero Height* weir. For this example, sharp crested has been selected. If the Ogee had been selected, two additional fields and a **Cd** button would have popped up allowing the user to enter a *Spillway Approach Height* and a *Design Energy Head*. For the Ogee weir, the user can either enter a weir coefficient or have the program compute a weir coefficient by clicking on the **Cd** button.

The next category is *Weir Stationing Reference*. The field *HW Distance to Upstream XS* was set to zero feet, signifying that the lateral weir starts

immediately at the upstream cross section. The field titled "*TW flow goes*" was left at the default setting and should have no influence on the results because the tailwater was set to go "Out of the system" on the Lateral Structure Editor (see Figure 20.2).

The right side of the editor has two columns for the station and elevation data. These data points define the top of the lateral weir and are entered in the upstream to the downstream direction. Similar to cross section data, the stationing for the data can be based on any horizontal datum. In this example, the weir starts at an elevation of 11.13 feet at an arbitrary horizontal station of zero and concludes at an elevation of 10.94 feet at station 100.

The bottom left side of the editor has two buttons labeled "*HW Connections*" and "*TW Connections*", which are used to locate the lateral structure along the stream spatially. The upstream cross section is the first normal cross section immediately upstream of the lateral weir based on river stationing. (Between two normal river cross sections, there can be one or more lateral weirs.) In this example, the upstream cross section is 600\* and the upstream end of the lateral weir is zero feet from this cross section. So the *HW Distance* has been entered as zero feet. The program will compute the distances to downstream cross sections based on where the lateral weir is located. In this example, the *HW Position* of the lateral weir has been specified as next to the right bank station (see above). This means that the program will use the main channel reach lengths of 50 feet. Therefore, the lateral weir, which is 100 feet long, intersects the downstream river station 500 and extends no farther.

It should be noted that the lateral weir cannot cross more than 98 cross sections. If this happens, the user should break the lateral weir into two or more weirs that are physically adjacent. However, breaking the lateral weir into two or more weirs might cause the program to take longer to converge during the iterative process.

## Unsteady Flow Data

The user is required to enter boundary conditions and initial conditions for the system at the beginning of the simulation period. The **Unsteady Flow Data Editor**, shown in Figure 20.5, was selected from the main program window under the **Edit** menu. In this example the upstream boundary condition was a flow hydrograph that's start time coincided with the simulation time. The downstream boundary condition was normal depth and a friction slope of 0.00189 was entered. The initial conditions cell was left blank, which causes HEC-RAS to use the first flow from the reach's flow hydrograph that was used for the upstream boundary condition. For additional information on unsteady

flow data refer to Chapter 8 of the User's Manual, Performing an Unsteady Flow Analysis.

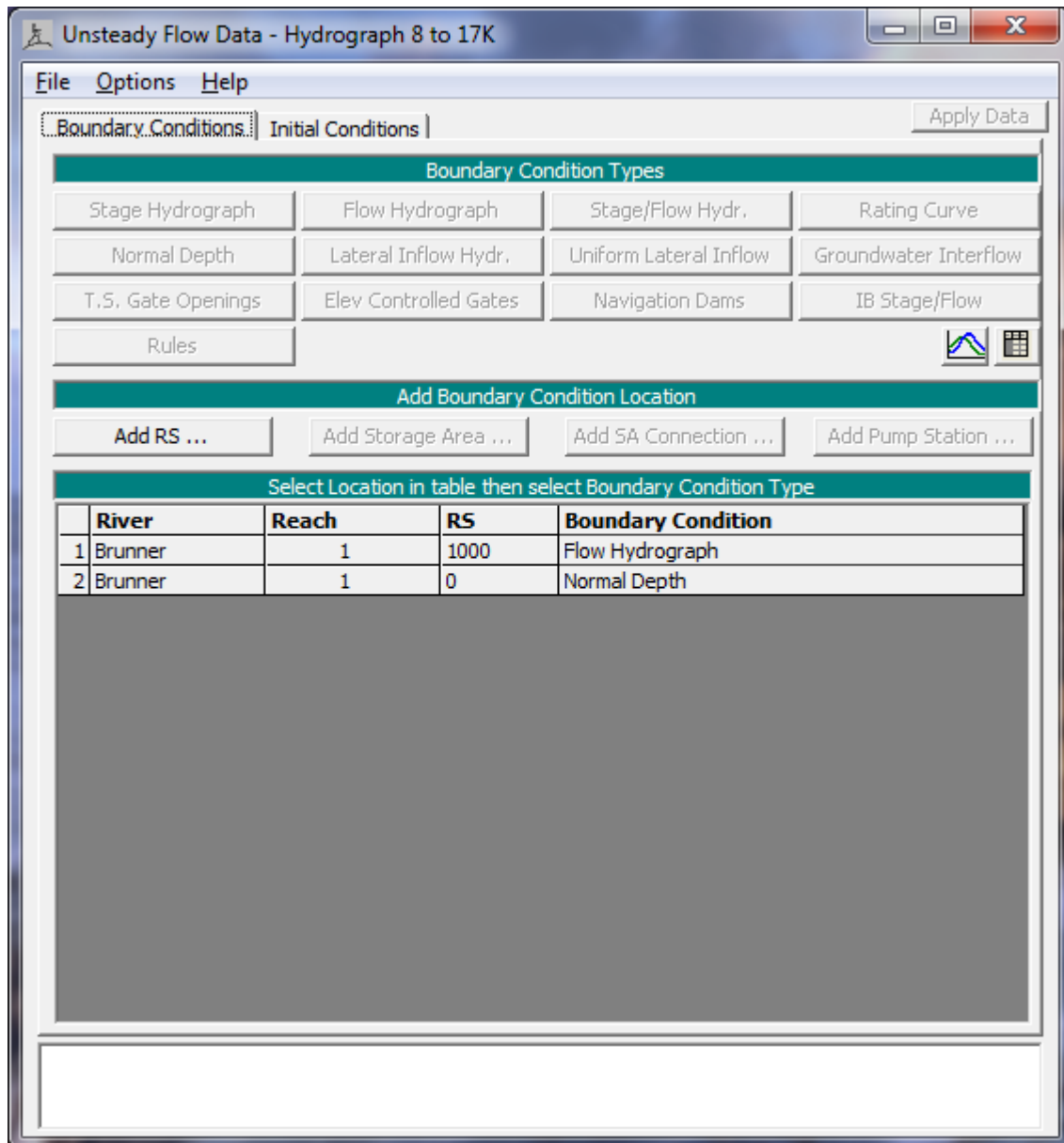

Figure 20-5. Unsteady Flow Data Editor

## Unsteady Flow Analysis

After the geometry and unsteady flow data have been completed an unsteady flow analysis may be initiated. Under the main program window **Unsteady Flow Analysis** was selected under the **Run** menu. This will display the

**Unsteady Flow Analysis Window** shown in Figure 20.6. A plan was defined by selecting the Geometry File "Rect chan S=10ft/mi Sharp Crested" and the Unsteady Flow File "Hydrographs 8 to 17K." Under the **File** menu, **Save Plan As** was selected and the plan title was entered as "Unsteady Sharp Crest S=10ft/mi." After entering the title of the plan a short identifier was entered as "UnstShrpCrest" and the plan was saved. The data was entered as seen in Figure 20.6 below. For more information on the *Simulation Time Window*, *Computation Settings*, and *Programs to Run* refer to "**Unsteady Flow Application – Example 17**".

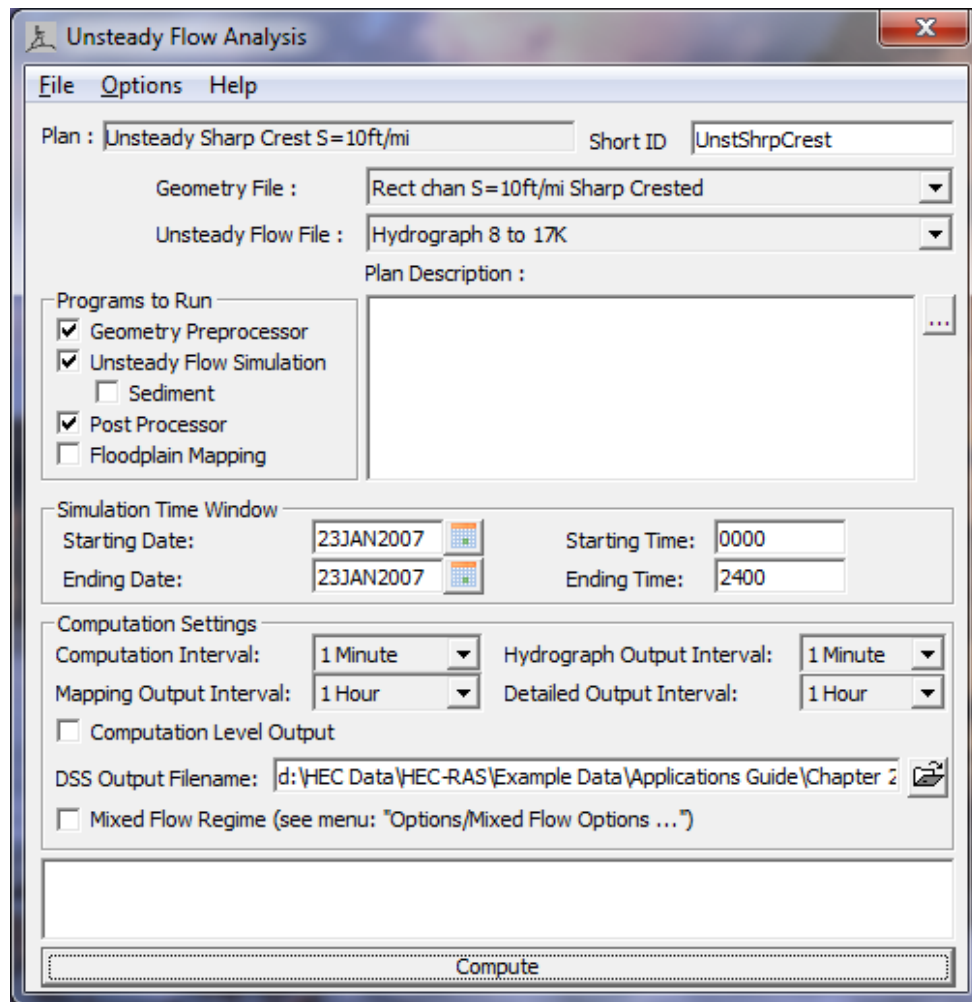

Figure 20-6. Unsteady Flow Analysis

## Output Analysis

For the analysis of the output, the water surface profiles, the lateral structure detailed output table, and the lateral structure profile summary table will be reviewed. Each of these is described in the following sections.

### Water Surface Profiles

The water surface profiles are shown in Figure 20.7. This figure was activated from the main program window by selecting **View** and then **Water Surface Profiles**. The figure shows the peak water surface profile (*Max WS*) and the water surface created by the initial hydrograph flow. As seen in the profile plot, the lateral weir has negligible impact on the water surface profile of the river at lower flows but has a more significant impact at higher elevations when a higher percentage of the flow is diverted through it.

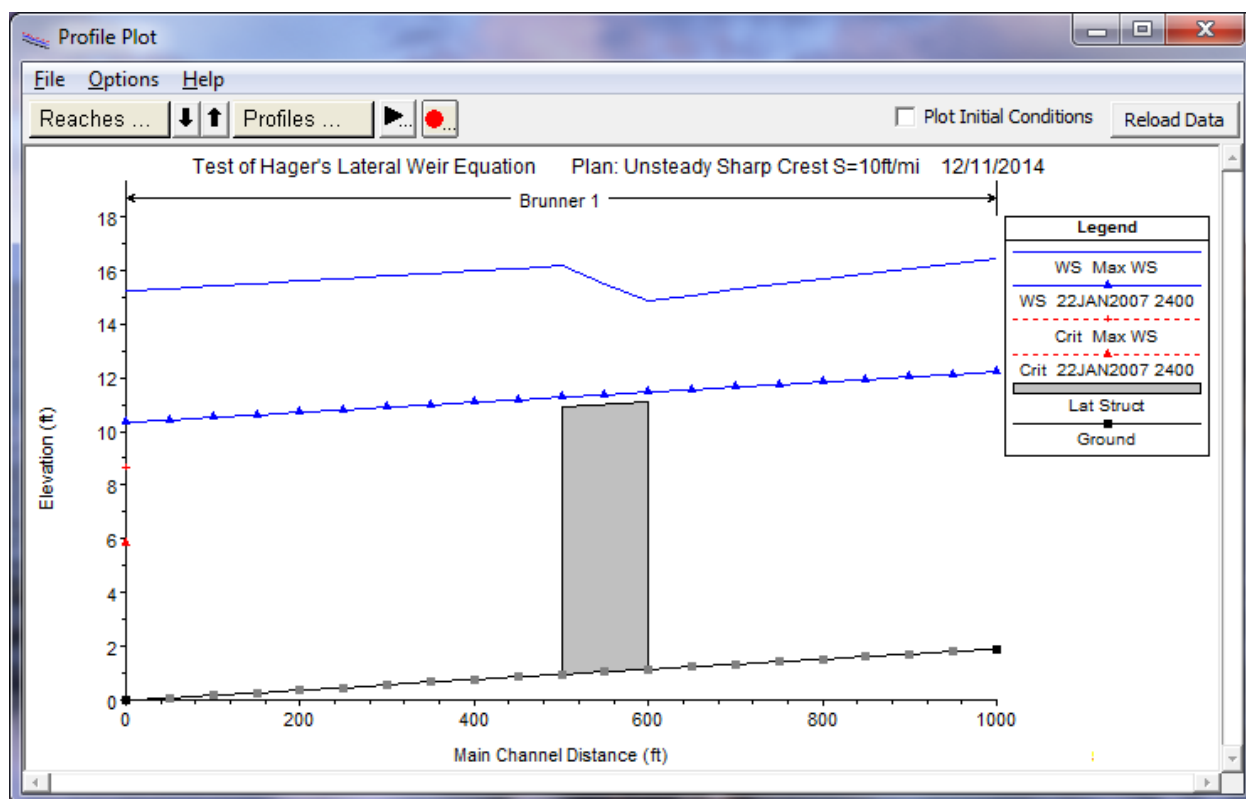

Figure 20-7. Water Surface Profiles of Peak and Initial Flows for Brunner River

### Lateral Structure Detailed Output Table

To review the detailed hydraulic results for the lateral structure the Lateral Structure type **Detailed Output Table** was activated and is show in Figure

20.8. This table was activated from the main program window by selecting **View, Detailed Output Table, Type**, and then **Lateral Structure**.

At the top of the table, *River* was selected as Brunner, the *Reach* was selected as "1" and the river station was 599 (the node for the lateral weir). The profile was selected as "Max WS."

The table shows the energy grade and water surface at the upstream and the downstream end of the weir. For this profile, the energy grade at the start of the lateral structure is 17.24 feet and 17.56 feet at the downstream end. The total flow upstream of the lateral structure is 17000 cfs, whereas the total flow downstream of the lateral structure is 14448.99 cfs (the lateral structure is spilling 2551.02 cfs or 15.01% of the flow). The weir coefficient calculated for the Max WS profile was 2.703. For lower flow profiles the weir coefficient was calculated to be a lower value (e.g. Profile 23JAN2007 2300 has a weir coefficient of 2.141). The user is encouraged to look through the results and compare the weir coefficient values calculated by Hager's equation for each time step.

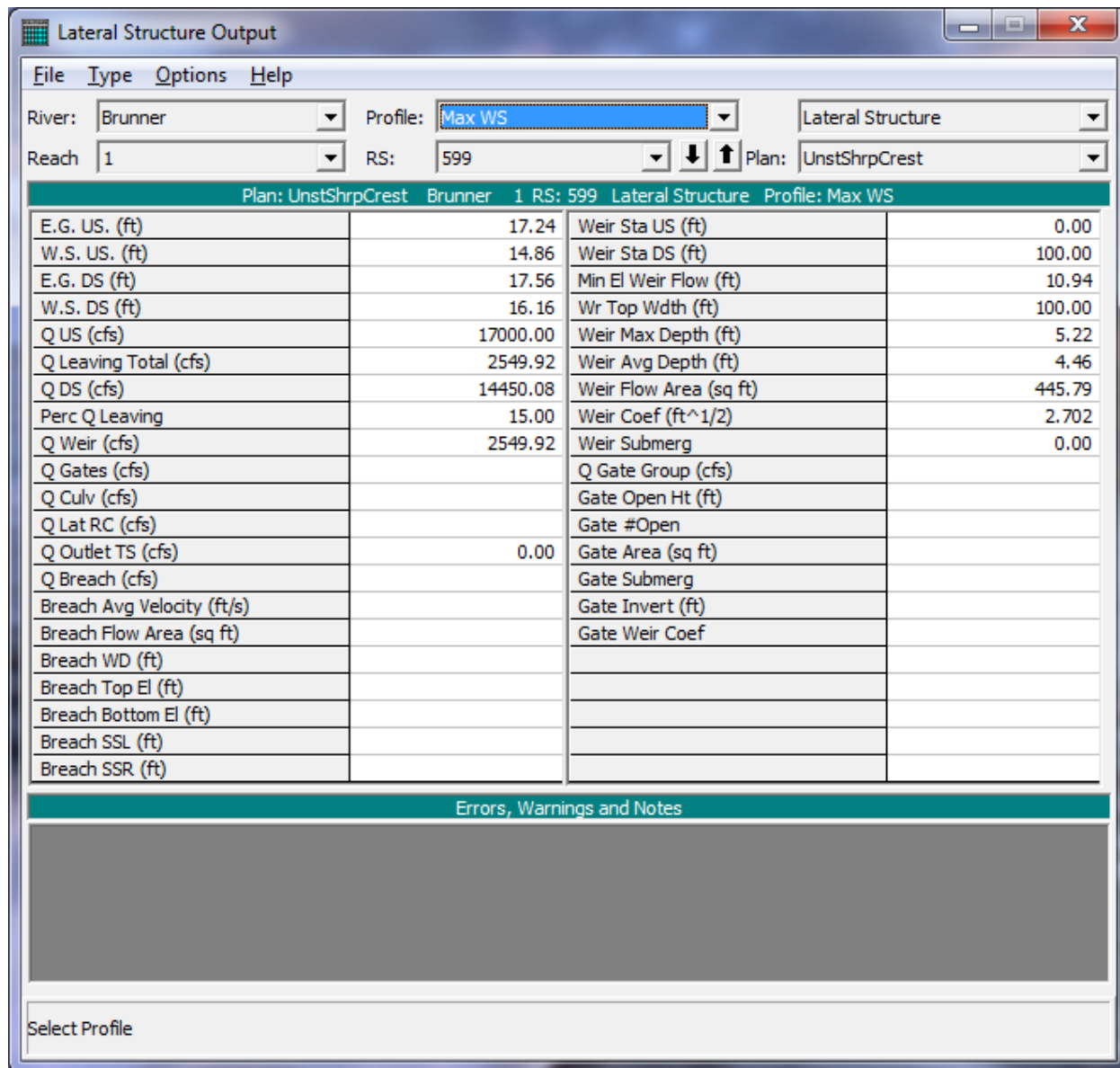
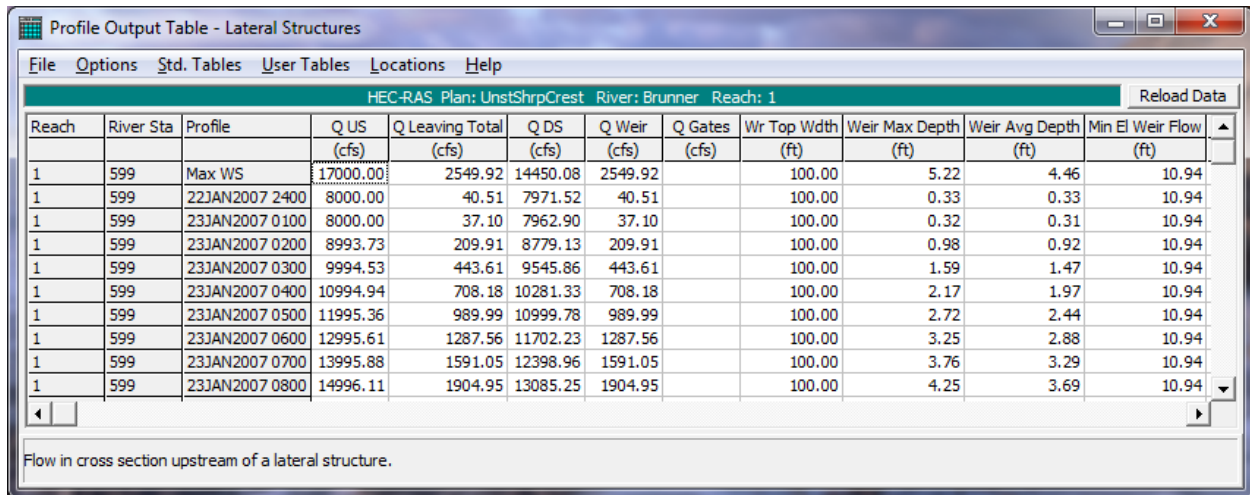

Figure 20-8. Lateral Weir Output Table for Max WS Profile

### Lateral Structure Profile Summary Table

The **Lateral Structure Only Profile Summary Table** is shown in Figure 20.9. This figure was activated from the main program window by selecting **View, Profile Summary Table, Std. Tables**, and then **Lateral Structure**. The figure displays the water surface elevations, energy grade line, and total weir flows for each of the profiles. This table is beneficial when the user wants to evaluate and compare several profiles at once.





Reach	River Sta	Profile	Q US (cfs)	Q Leaving Total (cfs)	Q DS (cfs)	Q Weir (cfs)	Q Gates (cfs)	Wr Top Width (ft)	Weir Max Depth (ft)	Weir Avg Depth (ft)	Min El Weir Flow (ft)
1	599	Max WS	17000.00	2549.92	14450.08	2549.92		100.00	5.22	4.46	10.94
1	599	22JAN2007 2400	8000.00	40.51	7971.52	40.51		100.00	0.33	0.33	10.94
1	599	23JAN2007 0100	8000.00	37.10	7962.90	37.10		100.00	0.32	0.31	10.94
1	599	23JAN2007 0200	8993.73	209.91	8779.13	209.91		100.00	0.98	0.92	10.94
1	599	23JAN2007 0300	9994.53	443.61	9545.86	443.61		100.00	1.59	1.47	10.94
1	599	23JAN2007 0400	10994.94	708.18	10281.33	708.18		100.00	2.17	1.97	10.94
1	599	23JAN2007 0500	11995.36	989.99	10999.78	989.99		100.00	2.72	2.44	10.94
1	599	23JAN2007 0600	12995.61	1287.56	11702.23	1287.56		100.00	3.25	2.88	10.94
1	599	23JAN2007 0700	13995.88	1591.05	12398.96	1591.05		100.00	3.76	3.29	10.94
1	599	23JAN2007 0800	14996.11	1904.95	13085.25	1904.95		100.00	4.25	3.69	10.94

Figure 20-9. Lateral Weir Profile Table

## Summary

This example used Hager's Lateral Weir Equation to compute flow profiles for a designed rectangular channel and sharp crested lateral weir. It was seen how the Hager's Lateral Weir Equation adjust the weir coefficient for each profile to account for difference in hydraulic conditions. By reviewing the lateral weir tables and the water surface profiles and tables, the user can determine the amount of flow being diverted by the lateral weir and evaluate other hydraulic properties that are influenced by the presence of the weir.



## CHAPTER 21

## Overflow Gates

### Purpose

This example will demonstrate the use of HEC-RAS to analyze a river reach with storage areas that contains a storage area connection, inline weir, and lateral weir that have overflow gates.

To perform the analysis the user must enter the geometric data for the weirs and gated spillways, along with the geometry of the river reach and storage areas. Then, the user must set the gate opening schedule for each gate in the **Unsteady Flow Data Editor**. The modeler is referred to Chapter 6 of the User's Manual for discussion on entering the geometric data for the weir and gated spillways, Chapter 7 of the User's Manual for entering the gate opening flow data, and Chapter 8 of the Hydraulic Reference Manual for the hydraulic analysis procedures for analyzing the flow through the gate openings and over the weir.

To review the data files for this example, from the main HEC-RAS window, select **File** and then **Open Project**. Go to the directory in which you have installed the HEC-RAS example data sets. From the "**Applications Guide\Chapter 21 – Overflow Gates**" subdirectory, select the project labeled "**Test of Overflow Gates.**" This will open the project and activate the following files:

Plan: "Open Air Gates – Complex Network"

Geometry: "Complex network with Open Air Gates"

Flow: "Test event – Complex Network"

### Geometric Data

To view the geometric data for the river system, from the main program window select **Edit** and then **Geometric Data**. This will activate the **Geometric Data Editor** and display the river system schematic as shown in Figure 21.1. The schematic displays the 11 river stations of the reach "Marston Creek" on "Overflow Reach", with river station 1000 as the upstream cross section and zero as the downstream cross section.

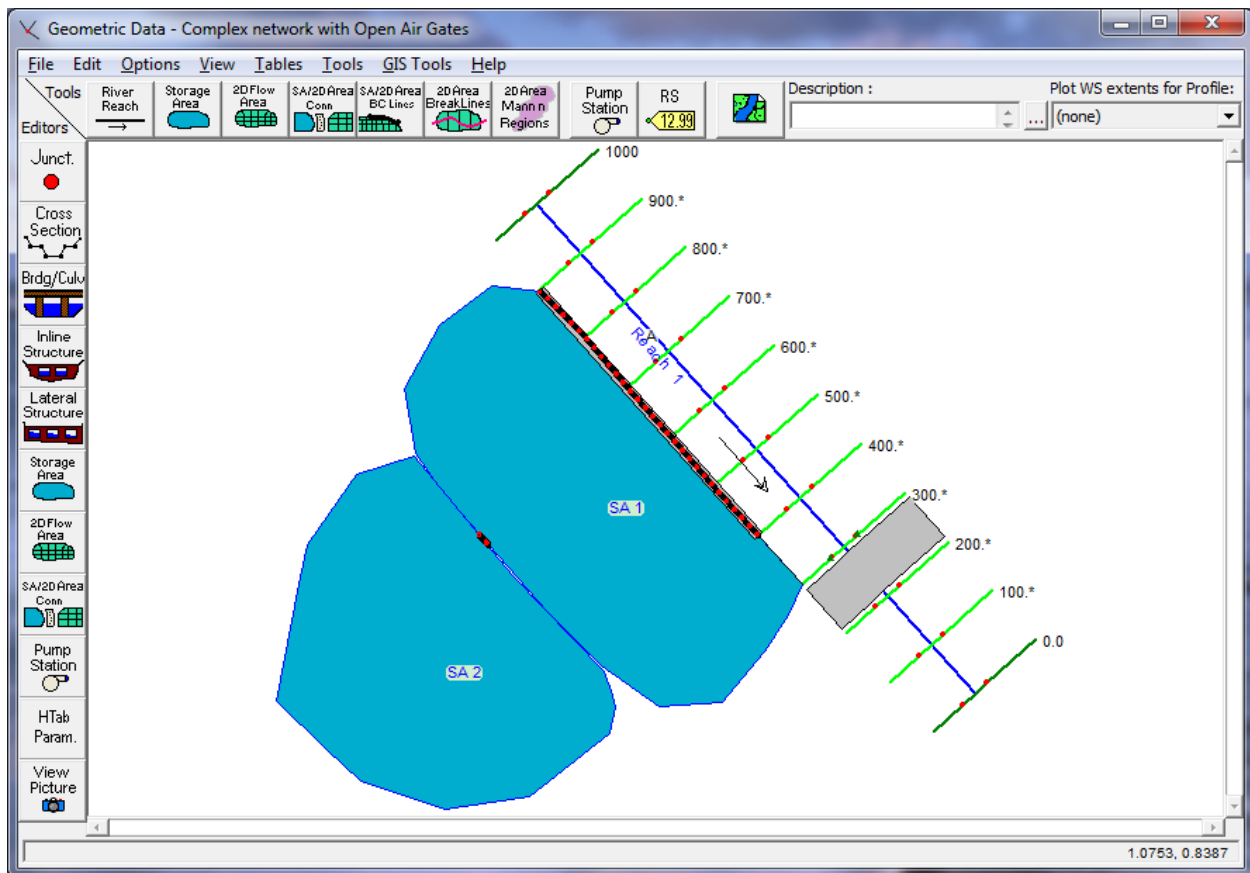

Figure 21-1. River System Schematic for Marston Creek with Storage Areas

## Cross Section Data

The cross section data consists of the X-Y coordinates, Manning's n values, contraction and expansion coefficients, etc. The user can view this data for each river station by selecting the **Cross Section** icon on the left side of the **Geometric Data Editor**. For this example, an inline structure was added at river station 250 and a lateral structure connected to a series of storage areas was added at river station 899. These elements will be discussed in the next section. The upstream and downstream cross sections were manually entered while the nine river stations in between were interpolated. For more information on entering cross section data and interpolating cross sections look to "Example 1 Critical Creek" and Chapter 6 of the **User's Manual**.

## Inline Structure

To add an inline structure, the **Inline Structure** icon was selected from the left side of the **Geometric Data Editor**. This activated the **Inline Structure Data Editor** as shown in Figure 21.2. Then, **Options** and **Add an Inline Structure** were selected and river station 250 was entered as the location for the weir. The schematic then displayed the cross section data for the river station immediately upstream of the weir location: namely river station 300 for this example.

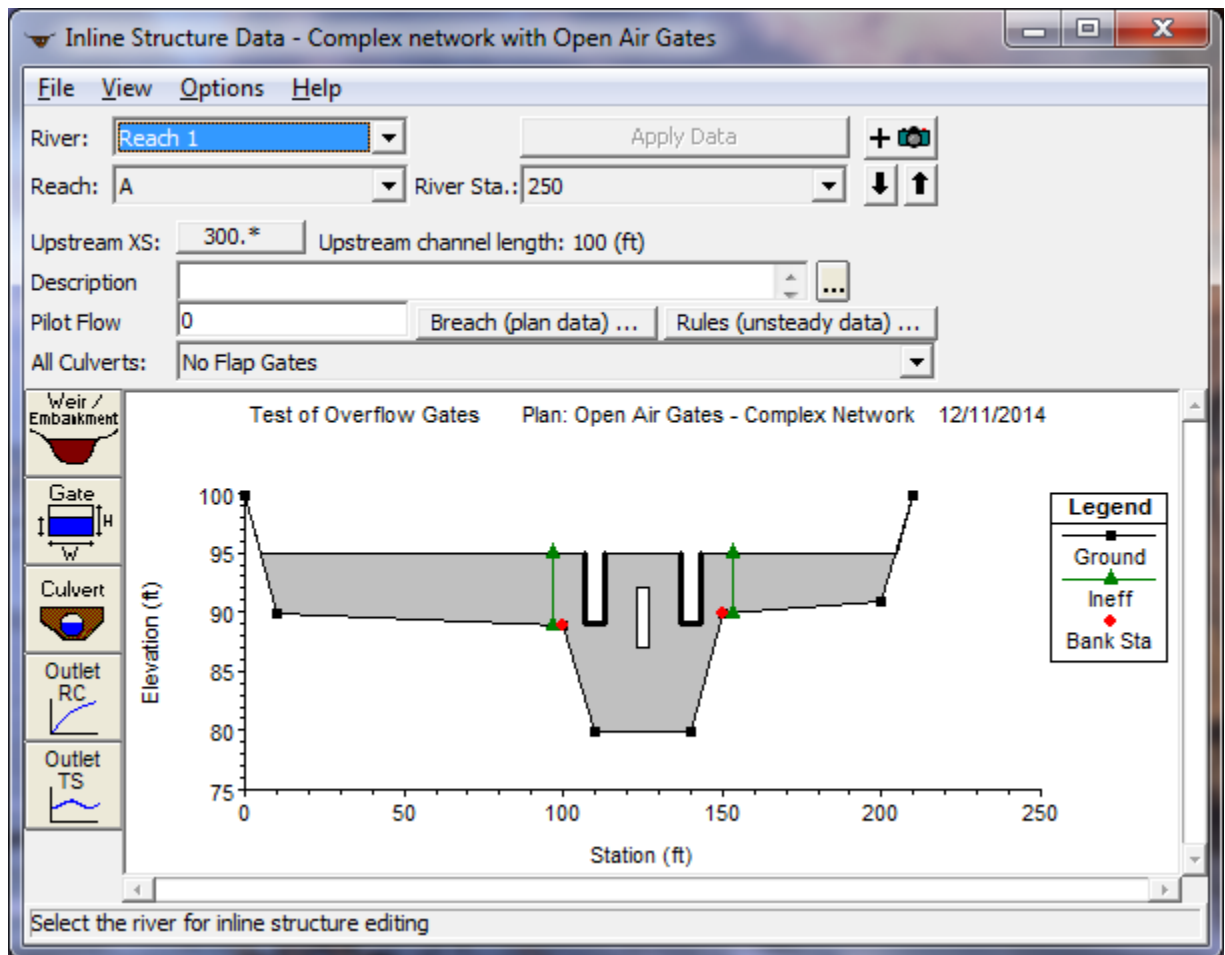

Figure 21-2. Inline Structure Data Editor

To enter the data for the weir, the **Weir/Embankment** icon was selected from the left side of the **Inline Structure Data Editor**. This activated the **Inline Structure Station Elevation Data Editor** as shown in Figure 21.3. This editor is similar to the deck/roadway editor used for bridges and culverts.

Distance	Width	Weir Coef
10	80	2.6

Edit Station and Elevation coordinates	
Station	Elevation
1 0.	95.
2 210.	95.
3	
4	
5	
6	
7	
8	

U.S Embankment SS: 0      D.S Embankment SS: 0

Weir Data  
 Weir Crest Shape  
 Broad Crested  
 Ogee

OK      Cancel

Enter distance between upstream cross section and deck/roadway. (ft)

Figure 21-3. Inline Structure Station Elevation Data Editor

The top row of the editor consists of three data entry fields. For the first field, the user must enter the *Distance* from the upstream cross section (RS 300) to the upstream side of the weir. For this example, this distance was 10 feet. Next, the *Width* of the weir was entered as 80 feet. This is a total distance of 90 feet. The distance from river station 300 to 200 is 100 feet. Therefore, the distance from the downstream end of the weir to cross-section 200 is 10 feet. The last field in the top row of the editor is the *Weir Coefficient* and was entered as 2.6, coinciding with the *Broad Crested* weir shape chosen at the bottom of the editor.

The central portion of the editor consists of a table in which the user must enter the station and elevation data for the weir. The first station of the weir was entered as zero and the last station is at 210 feet – both have an elevation of 95 feet. With these weir stations and elevation, the program will block out the entire area below the weir crest.

### Inline Structure Overflow Gates

To enter the data for the gates, the **Gate** icon was selected from the **Inline Structure Data Editor** (Figure 21.2). This activated the **Gate Editor** as shown in Figure 21.4. There are two gate types utilized for this structure:

*Overflow (open air)* and *Overflow (closed top)*. For this example, two open air overflow gates and one closed top overflow gate were entered. The gates were divided into two groups - the open air overflow gates in one group and the closed top gate in the other. A second gate group was created by clicking the *New Gate Group* icon (looks like a blank sheet of paper and is located at the top of the editor).

Inline Gate Editor

Gate Group: Gate #2

Gate type (or methodology): Overflow (closed top)

Geometric Properties

Height: 5

Width: 4

Invert: 87

# Openings: 1

Centerline Stations

	Station
1	125.
2	
3	
4	
5	
6	
7	
8	
9	
10	
11	
12	

Gate Flow

Sluice Gate Flow

Sluice Discharge Coefficient (0.5-0.7): 0.6

Submerged Orifice Flow

Orifice Coefficient (typically 0.8): 0.8

Head Reference: Sill (Invert)

Weir Flow Over Gate

Weir Shape: Broad Crested

Weir Coefficient: 2.6

OK Cancel Help

Figure 21-4. Inline Gate Editor for Gate #2

For Gate Group #1, the *Height*, *Width*, and *Invert* of the two openings were entered as 6, 6, and 89 feet, respectively. On the lower left side of the editor, the centerline stations for the two gates in group one were entered as 110 and 140. As these values were entered, the counter field *# Openings* increased to represent the total number of gates for the group (two for this example). The *Weir Shape* was chosen as "Broad Crested" from the dropdown menu and its coefficient was entered as 2.6. Unlike the closed top overflow gate, the open air overflow gate does not require the user to enter values for sluice gate flow or submerged orifice flow because it only experiences weir flow.

The information for gate group two was entered by first selecting it from the *Gate Group* dropdown menu in the top left corner of the **Inline Gate Editor**. The *Height*, *Width*, and *Invert* of the closed top overflow gate (chosen from the *Gate type* dropdown) were entered as 5, 4, and 87 feet, respectively. The centerline station is 125.

The remaining portion of the editor is divided into two sections, one for the Gate Flow data and one for Weir Flow data. The gate data is used when the water surface upstream of the gate is greater than 1.25 times the gate opening (as measured from the gate invert). At this water surface elevation, the gate is controlling the flow rate. The weir data is the shape of the weir under the gate and is used when the upstream water surface is less than or equal to the gate opening. At this water surface elevation, the weir under the gate is controlling the flow through the gate opening (i.e., the water is not in contact with the gate).

Since the first field - *Gate Type* - has already been chosen as *Overflow (closed top)* the fields below it should have already been visible. The *Sluice Discharge Coefficient* was entered as 0.6. The *Orifice Coefficient* was kept at its default value of 0.8 for fully submerged flow conditions. Additionally, the head reference for the gate equation defaults to the "Sill (invert)" of the gate opening. This is appropriate for gates that release water to a channel, rather than to the free atmosphere.

For the Weir Flow data, the *Weir Shape* was selected as "Broad Crested". The weir coefficient was entered as 2.6.

The **OK** button was selected at the bottom of the **Gate Editor** and the gates appeared on the **Inline Structure Data Editor** as shown in Figure 21.2. (Note: The ineffective flow areas will be entered subsequently.) At this point, the user should zoom in on the gate openings to ensure that they do not overlap and appear as intended. The **Inline Structure Data Editor** was then closed.

## Ineffective Flow Areas

As performed for bridges and culverts, ineffective flow areas should be entered on the cross sections that bound the inline structure. For this example, the cross section that is upstream of the structure is 300 and the cross section downstream of the structure is 200. To enter the ineffective flow areas, the **Cross Section** icon was selected from the **Geometric Data Editor** (Figure 21.1). Then, river station 300 was selected and **Ineffective Flow Areas** was selected from the **Options** menu. This activated the **Ineffective Flow Editor** as shown in Figure 21.5.

The distance from the inline structure (river station 250) to river station 300 is 10 feet. The left edge of the gates at river station 300 is station 107. Therefore, the left ineffective flow area was set to begin at  $107 - 10 = 97$ . Similarly, the right ineffective flow area was set at station  $153 (= 143 + 10)$ .



The elevation of both the left and right ineffective flow areas is 95 feet, which coincides with the top of the weir. The **OK** button on the editor was selected and similar ineffective flow areas were entered at river station 200.

Figure 21-5. Ineffective Flow Editor

## Creating Storage Areas

When creating the storage areas, first the **Storage Area** icon was selected from the **Tools** toolbar (not to be confused with the Storage Area icon from the Editors toolbar) of the **Geometric Data Editor**. The pointer was then placed on the edge of the right overbank of Overflow Reach and the storage area was drawn by single clicking and dragging the mouse for each desired point for the storage area. The final point for the storage area was selected by double clicking the mouse. Upon double clicking the mouse, a dialog box appears requesting a storage area name. The name "SA 1" was entered. Points on a storage area may be added or removed by using the **Add Points** to a Reach or SA and **Remove Points** to a Reach or SA options found in the Edit menu. The same steps were taken to create SA 2.

## Entering Data for a Storage Area

After the storage area was drawn in the **Geometric Data Editor** the surface area for storage was entered. The data was entered in the **Storage Area Editor**, displayed in Figure 21.6, found by selecting the **Storage Area** icon on the **Editors** toolbar. For both SA 1 and SA 2 the **Area times depth method** was selected. An area of 25 acres with a minimum elevation of 90 feet and an area of 10 acres with a minimum elevation of 90 feet was entered for SA 1 and SA 2, respectively. This method computes the product of a constant area and change in water surface elevation to calculate storage volume.

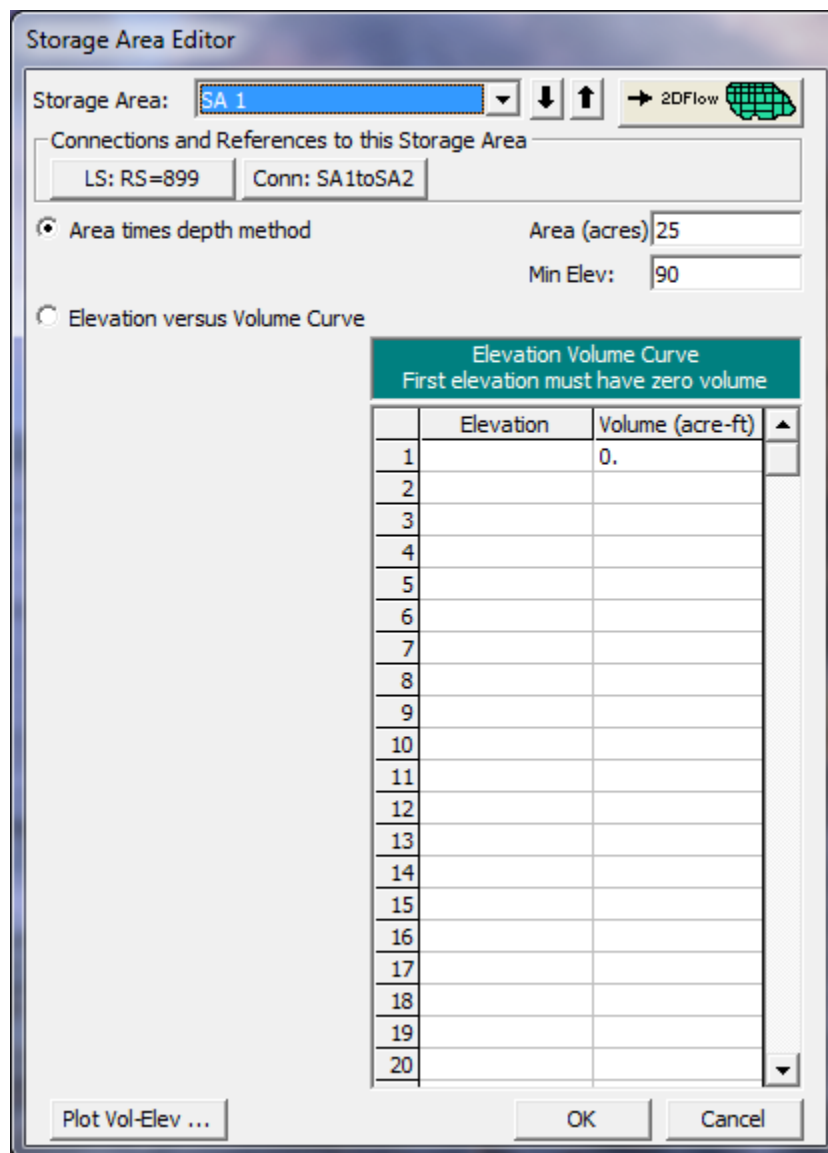

Figure 21-6. Storage Area Editor for SA 1

### Lateral Structure Connected to a Storage Area

A lateral structure was placed at river station 899 that connected Overflow Reach to SA 1. This was accomplished by selecting the **Lateral Structure** icon from the **Editors** toolbar in the **Geometric Data Editor**. After selecting the icon, the **Lateral Structure Data Editor** appears, as shown in Figure 21.7. With the reach selected as Overflow Reach, under the **Options** menu, **Add a Lateral Structure** was selected. The location of the structure was entered at 899. This placed the beginning of the structure between river stations 900 and 800.

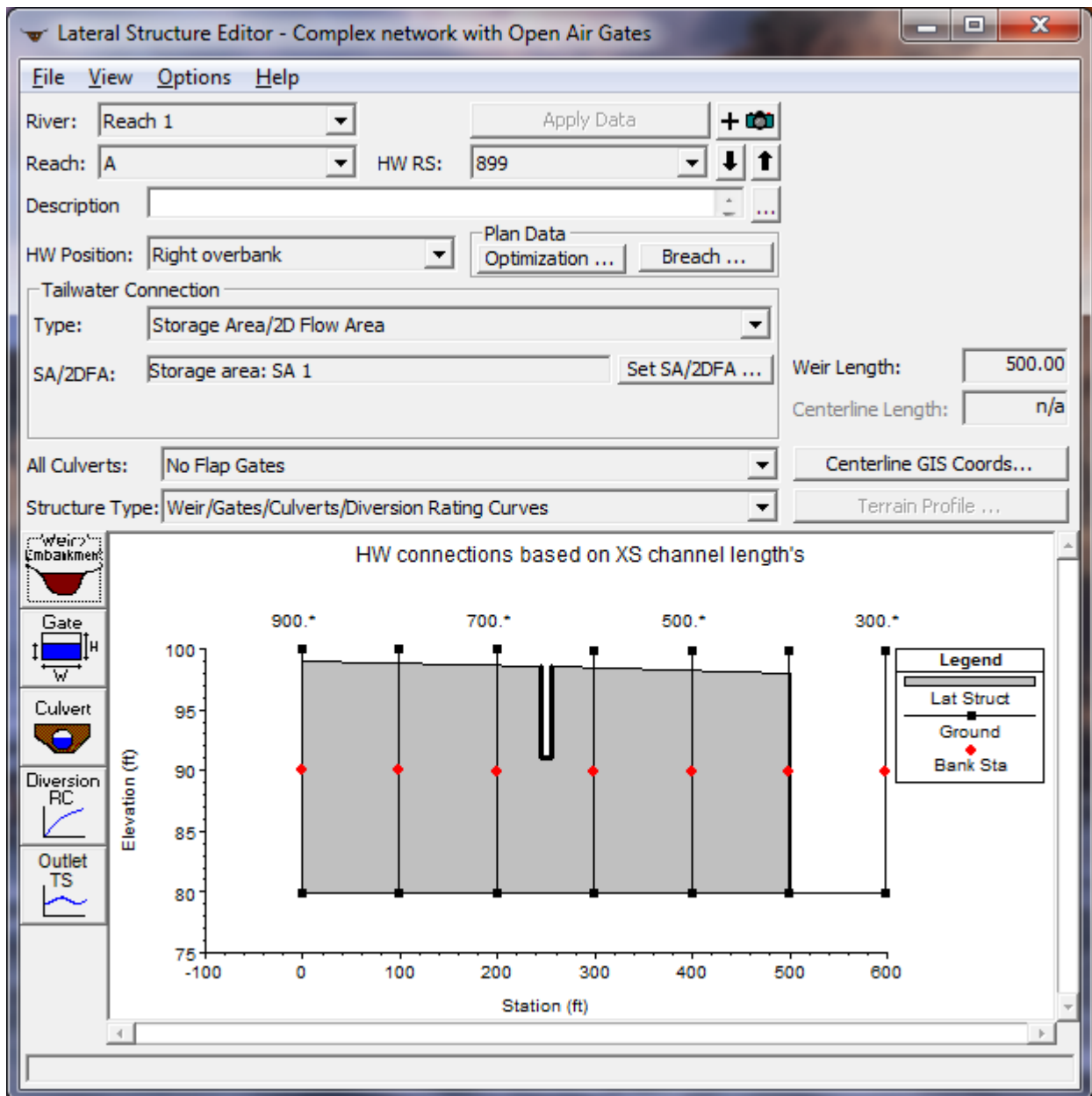

Figure 21-7. Lateral Weir Data Editor

To enter data for the structure, the **Weir/Embankment** icon was selected from the **Lateral Structure Data Editor**. The data was entered as shown in Figure 21.8 on the **Lateral Weir Embankment Window**. The 500 foot weir is broad crested with a width of 15 feet, placed one foot from the upstream river station 900. "Water surface" was chosen as the weir flow reference method.

Returning to the **Lateral Structure Data Editor**, the *HW Position* was selected as "Right overbank" from the pull-down menu and the *Tailwater Connection Type* was chosen as *Storage Area*. Lastly, a connection was made to the storage area by selecting the **Set SA** button. A window then popped up, allowing the user to select a storage area to connect to. On the pull-down menu "Storage area: SA 1" was selected.

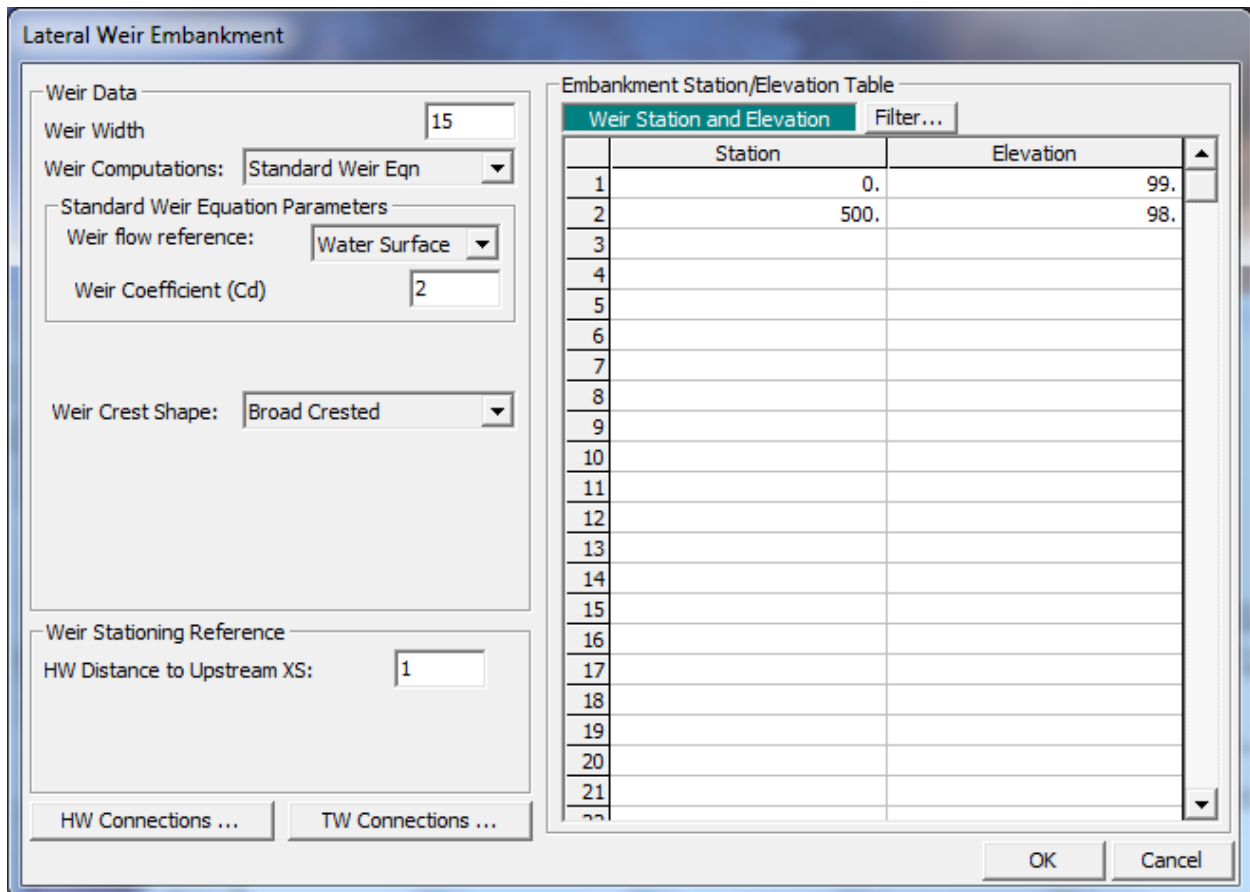

Figure 21-8. Lateral Weir Embankment Window

### Lateral Structure Overflow Gates

To enter the data for the gates, the **Gate** icon was selected from the **Lateral Structure Data Editor** (Figure 21.7). This activated the **Gate Editor** as shown in Figure 21.9.

The screenshot shows the 'Lateral Gate Editor' dialog box. At the top, 'Gate Group' is set to 'Gate #1'. Below it, 'Gate type (or methodology)' is 'Overflow (open air)'. The 'Geometric Properties' section includes: Height: 7.5, Width: 10, Invert: 91, and # Openings: 1. The 'Weir Flow Over Gate' section includes: Weir Shape: Sharp Crested, Weir Method: User entered coefficient, and Weir Coefficient: 3.2. On the lower left, there is a 'Centerline Stations' table with 12 rows. The first row has '1' in the first column and '250.' in the second column. The other rows are empty. At the bottom are 'OK', 'Cancel', and 'Help' buttons.

Centerline Stations	
	Station
1	250.
2	
3	
4	
5	
6	
7	
8	
9	
10	
11	
12	

Figure 21-9. Gate Editor

The gate type was selected as "Overflow (open air)". The *Height*, *Width*, and *Invert* of the gate opening were entered as 7.5, 10, and 91 feet, respectively. On the lower left side of the editor, the centerline station for the gate was entered as 250. The *Weir Shape* was chosen as "Sharp Crested" from the dropdown menu and the "User entered coefficient" was selected as the weir method. The coefficient was entered as 3.2.

## Storage Area Connections

Storage area connections are used to connect storage areas to other storage areas. To make a connection from SA 1 to SA 2, the **Storage Area Connection** icon was selected from the **Tools** toolbar in the **Geometric Data Editor**. A line was drawn from SA 1 to SA 2 by right clicking on SA 1 and then double clicking on SA 2. A prompt came up that asked for the name of the connection and the name "SA1toSA2" was given to the storage area connector.

Next, the **Storage Area Connection** editor (Figure 21.10) was brought up by clicking the icon on the **Geometric Data Editor**. The storage areas were selected by pressing the **Set SA** buttons next to the **From** and **To** location fields. *Storage area: SA 1* was selected as the **From** location, and *Storage area: SA 2* as the **To** location. The **Structure Type** was chosen as *Weir and Gates* from the drop down menu. Next the **Weir/Embankment** icon was selected. A 100 ft long broad crested weir with a weir coefficient of 2.6 and weir width of 5 feet was entered at an elevation of 97 feet.

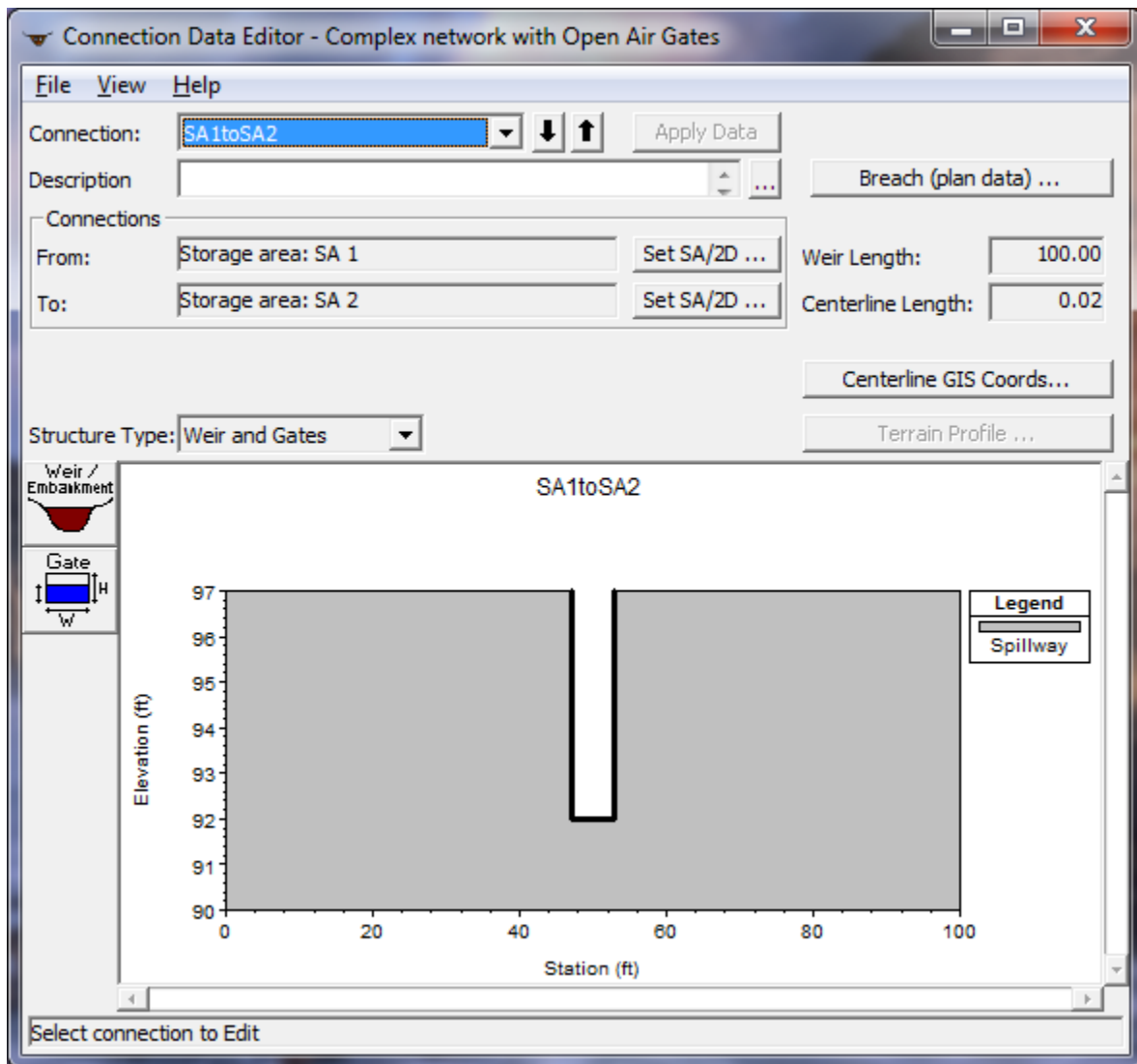

Figure 21-10. Storage Area Connection Editor for SA 1 to SA 2

### Storage Area Connection Overflow Gate

An opening in the embankment was placed along the centerline of the weir by selecting the **Gate** icon on the **Storage Area Connection Data Editor**. This selection displayed the **Connection Gate Editor** shown on Figure 21.11. An *Overflow (open air)* gate type was selected that had geometric properties as follows: height of 5 feet; width of 6 feet; invert elevation of 92 feet; and one opening at station 50. At low flows, the gate is modeled as a sharp crested weir with a user defined weir coefficient of 3.2. All entered input can be seen in Figure 21.11. The gate opening schedule was entered as an internal boundary condition in the **Unsteady Flow Data Editor** and is discussed further in a latter section.

Connection Gate Editor

Gate Group: Gate #1

Gate type (or methodology): Overflow (open air)

Geometric Properties

Height: 5

Width: 6

Invert: 92

# Openings: 1

Centerline Stations

	Station
1	50.
2	
3	
4	
5	
6	
7	
8	
9	
10	
11	
12	

Weir Flow Over Gate

Weir Shape: Sharp Crested

Weir Method: User entered coefficient

Weir Coefficient: 3.2

OK Cancel Help

Figure 21-11. Culver Data Editor for RS 1.9 to Eagle

## Unsteady Flow Data

The user is required to enter boundary conditions and initial conditions for the system at the beginning of the simulation period. For additional information on unsteady flow data refer to Chapter 8 of the User's Manual, Performing an Unsteady Flow Analysis. The **Unsteady Flow Data Editor**, shown in Figure 21.12, was selected from the main program window under the **Edit** menu.

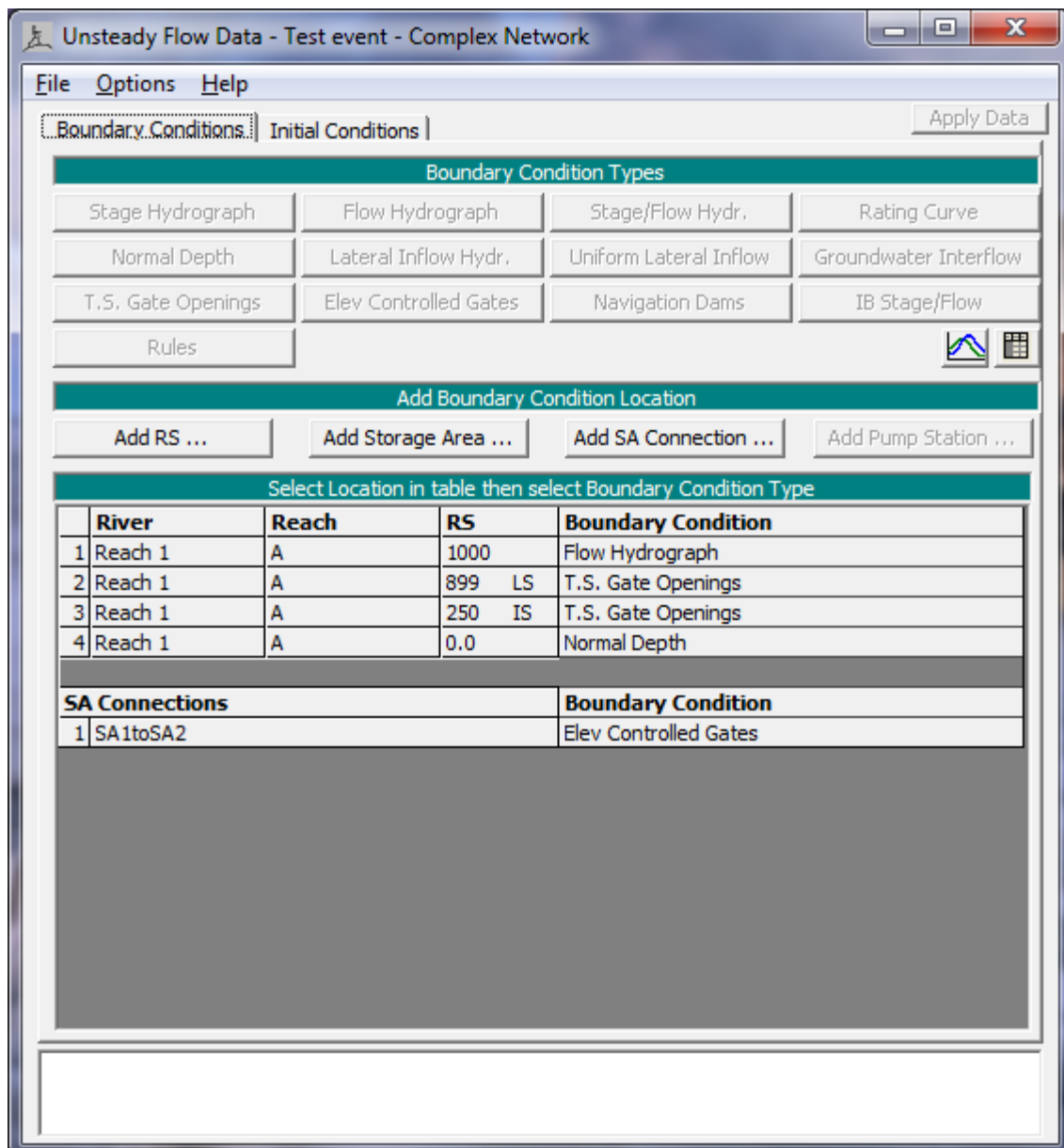

Figure 21-12. Unsteady Flow Data Editor



## Boundary Conditions

Boundary conditions are required for the farthest upstream and downstream cross sections. Upon entering the **Unsteady Flow Data Editor** the farthest upstream and downstream cross sections will be located in the boundary conditions column. In this case, the user will see River Station 1000 and River Station 0.0 as the upstream and downstream boundary conditions, respectively. Boundary conditions are set by highlighting the adjacent cell under **Boundary Condition Type**. When a cell is highlighted, not all boundary conditions are available. The program will automatically gray out all irrelevant boundary condition types. Internal boundary conditions may be added by selecting one of the buttons under the "Add Boundary Condition Location" heading.

## Upstream Boundary Condition

For River Station 1000 a flow hydrograph was selected as the boundary condition by highlighting the cell and pressing the **Flow Hydrograph** button. The window where the **Flow Hydrograph** is entered is shown in Figure 21.13. The user may select to read hydrograph data from a DSS file or manually enter the data. For further instruction on using a DSS file see *Unsteady Flow Application Example 17*. For this example the flow hydrograph was manually entered by selecting the **Enter Table** radio button. The **Data Time Interval** was set to one hour and the radio button **Use Simulation Time** was selected causing the initial propagation of the hydrograph to coincide with the beginning of the simulation time window. The hydrograph was then manually entered into the table.

**Flow Hydrograph**

River: Reach 1 Reach: A RS: 1000

Read from DSS before simulation Select DSS file and Path

File:

Path:

Enter Table Data time interval: 1 Hour

Select/Enter the Data's Starting Time Reference

Use Simulation Time: Date: 01JAN2006 Time: 1200

Fixed Start Time: Date:  Time:

No. Ordinates

Hydrograph Data			
	Date	Simulation Time	Flow
		(hours)	(cfs)
1	01Jan2006 1200	00:00	100.
2	01Jan2006 1300	01:00	100.
3	01Jan2006 1400	02:00	100.
4	01Jan2006 1500	03:00	100.
5	01Jan2006 1600	04:00	100.
6	01Jan2006 1700	05:00	100.

Time Step Adjustment Options ("Critical" boundary conditions)

Monitor this hydrograph for adjustments to computational time step

Max Change in Flow (without changing time step):

Min Flow:  Multiplier:

Figure 21-13. Flow Hydrograph for Upstream Boundary Condition

### Downstream Boundary Condition

For River Station 0.0 the boundary condition selected was normal depth. Again, the corresponding cell for that particular river station was highlighted and then the **Normal Depth** button was selected. A friction slope of 0.0002 was entered in the window that appears.

### Internal Boundary Conditions

Boundary conditions were entered for the gates of the inline structure, lateral structure, and the storage area connector. The lateral structure (RS 899) and the inline structure (RS 250) both utilized "T.S. Gate Openings" while the storage area connector used "Elev Controlled Gates." These boundary

condition types were selected in the same manner as the upstream and downstream boundary condition types were selected.

The time series gate openings for the inline and lateral structures were manually entered separately by selecting the **Enter Table** radio button on the **Gate Opening Editor** (Figure 21.14). The **Data Time Interval** was set to one hour and the radio button **Use Simulation Time** was selected causing the initial propagation of the hydrograph to coincide with the beginning of the simulation time window. The gate opening height was then manually entered into the table. Since the inline structure has two gate groups, the process had to be completed for each group. In this example, each gate group has a different gate schedule.

Gate Openings

River: Reach 1 Reach: A RS: 899

Gate Group: Gate #1

Read from DSS before simulation Select DSS file and Path

File:

Path:

Enter Table Data time interval: 1 Hour

Select/Enter the Data's Starting Time Reference

Use Simulation Time: Date: 01JAN2006 Time: 1200

Fixed Start Time: Date:  Time:

No. Ordinates Interpolate Missing Values Del Row Ins Row

Hydrograph Data			
	Date	Simulation Time (hours)	Gate Opening Height (ft)
1	01Jan2006 1200	00:00	1.
2	01Jan2006 1300	01:00	1.
3	01Jan2006 1400	02:00	1.
4	01Jan2006 1500	03:00	1.
5	01Jan2006 1600	04:00	1.
6	01Jan2006 1700	05:00	1.
7	01Jan2006 1800	06:00	1.
8	01Jan2006 1900	07:00	1.
9	01Jan2006 2000	08:00	1.

Plot Data OK Cancel

Figure 21-14. Gate Opening Editor for the Lateral Structure

The elevation controlled gate used for the storage area connector was entered in the **Elevation Controlled Gates** editor (Figure 21-15) that appeared once *Elev Controlled Gates* was selected as the boundary condition type. The gates operation is "Based on difference in stage," which was chosen from the

dropdown of the *Reference* field. Once selected, the rest of the fields appeared and were filled in as shown in Figure 21.15.

The *First Reference* and *Second Reference* were selected as "Storage area: SA 1" and "Storage area: SA 2," respectively, by clicking the **Set SA** button under each field and choosing the appropriate storage area from the dropdown. The *Stage difference at which gate begins to open/close* was set to 2/0. In laymen's terms this says that when the water surface in SA 1 is two feet above that of SA 2 the gate begins to open; when the water surface of the two storage areas are equal, the gate begins to close back.

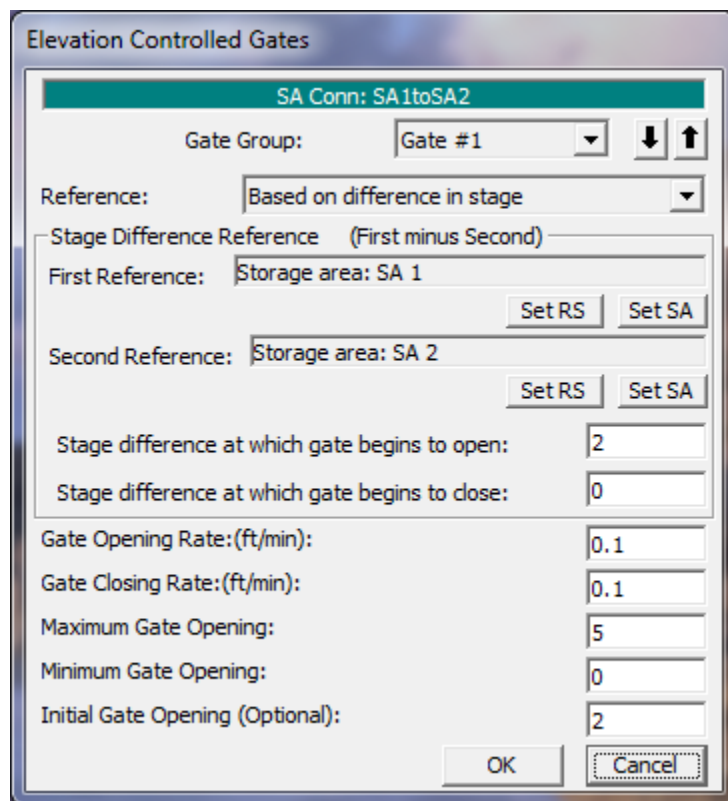

Figure 21-15. Elevation Controlled Gate Editor for Storage Area Connection

## Initial Conditions

Initial conditions consist of flow information at each of the cross sections, as well as elevations for any storage areas defined in the system. Data for initial conditions is established by selecting the **Initial Conditions** tab on the **Unsteady Flow Data Editor**. After selecting the tab, Figure 21.16 will be displayed.

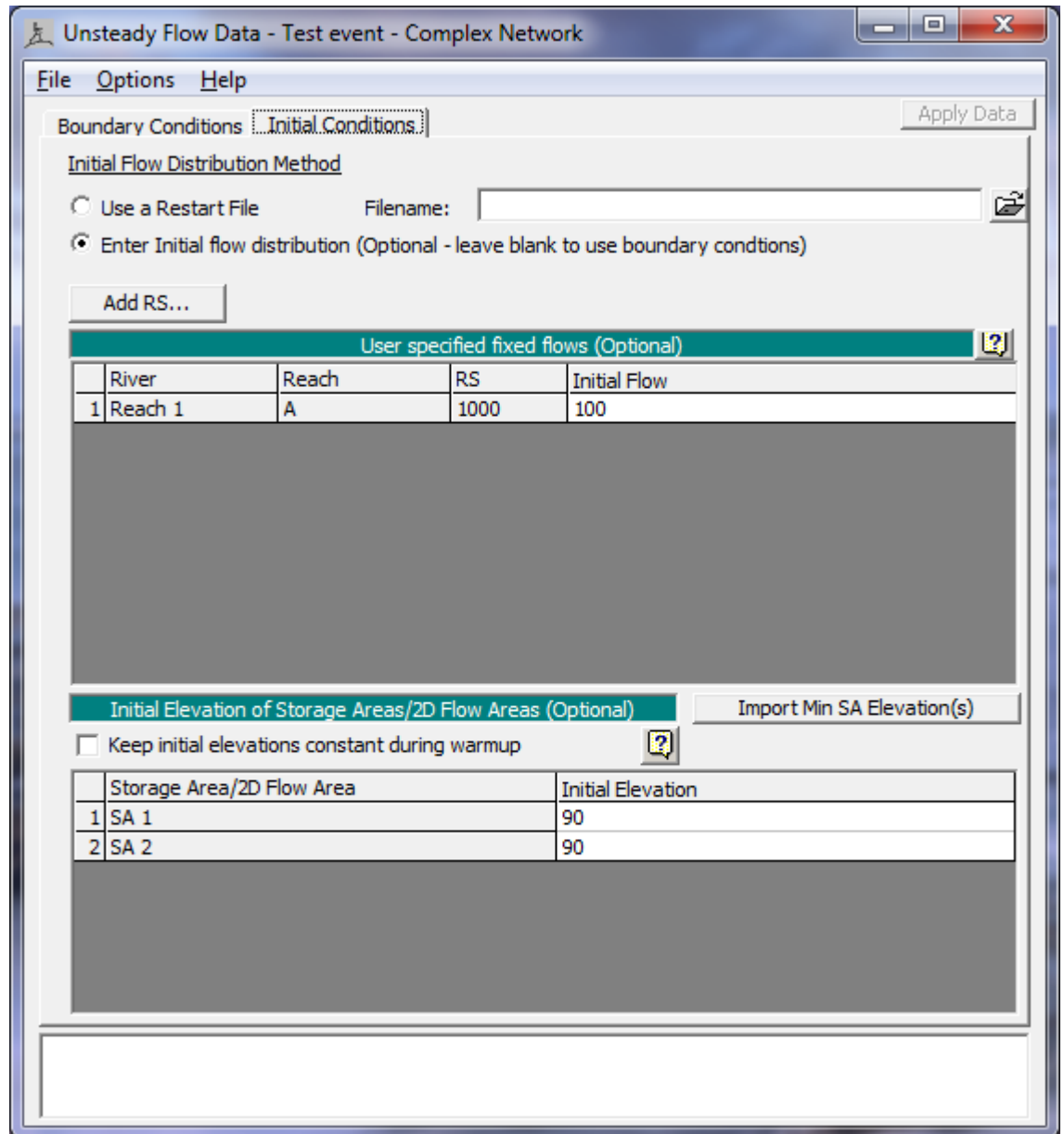

Figure 21-16. Unsteady Flow Data Initial Conditions

As seen in Figure 21.16, the **Enter Initial flow distribution** radio button was selected and an initial flow of 100 was entered for the most upstream river station (1000). The initial elevation of both storage areas was set to 90 feet. The data was then saved (**File -> Save Unsteady Flow Data As**) in the **Unsteady Flow Data Editor** and the window was closed.

## Unsteady Flow Analysis

After the geometry and unsteady flow data have been completed an unsteady flow analysis may be initiated. Under the main program window **Unsteady Flow Analysis** was selected under the **Run** menu. This will display the **Unsteady Flow Analysis Window** shown in Figure 21.17. A plan was defined by selecting the Geometry File "Complex network with Open Air Gates" and the Unsteady Flow File "Test event – Complex Network." Under the **File** menu, **Save Plan As** was selected and the plan title was entered as "Open Air Gates – Complex Network." After entering the title of the plan a short identifier was entered as "Open-Complex" and the plan was saved. The data was entered as seen in Figure 21.17 below. For more information on the *Simulation Time Window*, *Computation Settings*, and *Programs to Run* refer to "**Unsteady Flow Application – Example 17**".

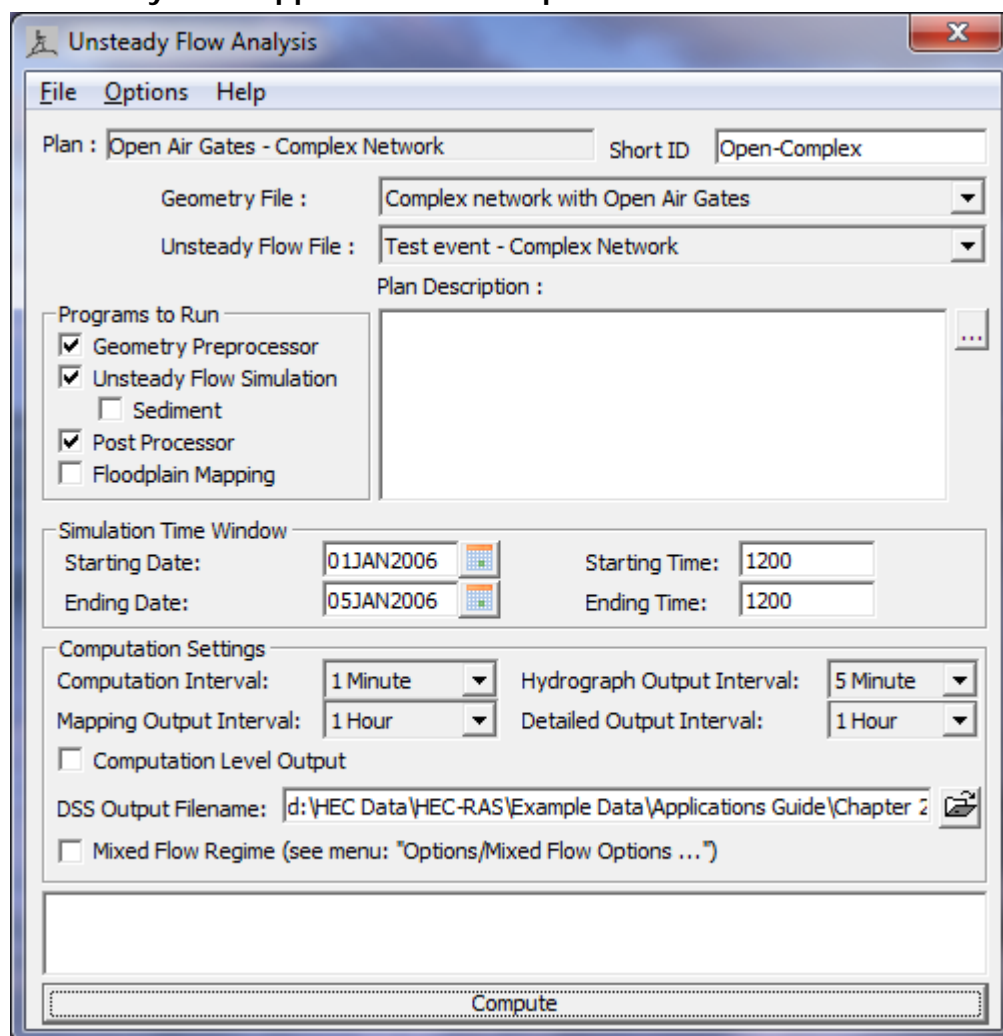

Figure 21-17. Unsteady Flow Analysis

## Output Analysis

For the analysis of the output, the *Water Surface Profiles*, the *Detailed Output Tables* and the *Profile Summary Tables* for all the gate structures will be reviewed. Each of these is discussed in the following sections.

### Water Surface Profiles

The water surface profiles are shown in Figure 21.18. This figure was activated from the main program window by selecting **View** and then **Water Surface Profiles**. The figure shows the maximum water surface profile as well as the gate openings for the lateral weir (RS 899) and the inline weir (RS 250).

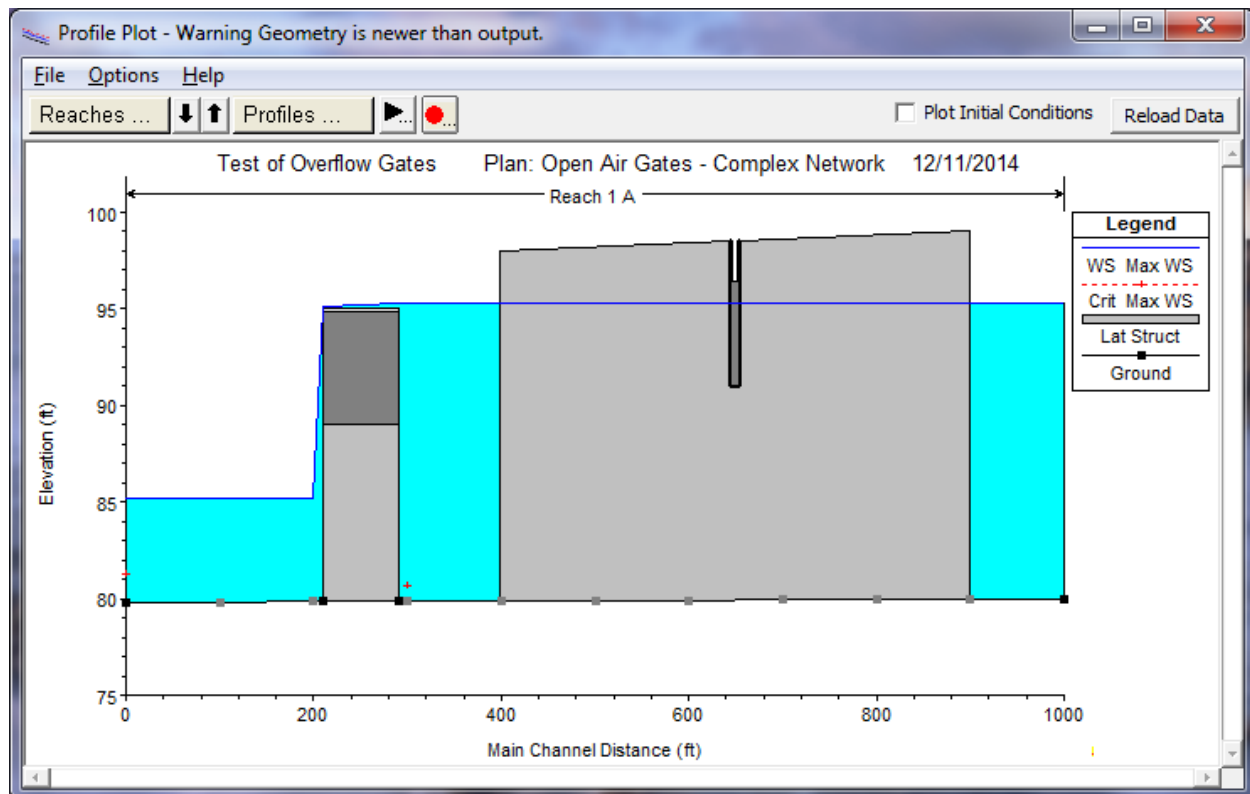

Figure 21-18. Water Surface Profiles for Marston River

### Detailed Output Tables

To review the flow parameters through the gate openings, the **Inline Structure** type **Detailed Output Table** was activated and is shown in Figure 21.19. This table was activated from the main program window by selecting **View**, **Detailed Output Table**, **Type**, and then **Inline Structure**. The

**Lateral Structures** and **Storage Area Connections** can also be viewed by selecting them from the **Type** menu.

At the top of the table, "Overflow Reach" was selected as the *Reach* and the river station was 250 (the cross section for the inline structure). As shown in Figure 21.19, the profile was selected as "Max WS" and the *Gate ID* was selected as "Gate #1." The details for the inline structure's other gate can be viewed by selecting "Gate #2."

As seen in the right column of the output table, the Gate #1 group has two gates opened 1.02 feet at the time of the maximum water surface. At the maximum water surface profile, gate group #1 passes 56.26 cfs of the total 133.97 cfs flowing through the inline structure. The remainder of the flow passes through Gate #2 (3.48 cfs) and over the weir (74.23 cfs). The overflow gates invert elevation at the time is 93.98 feet (Gate invert + gate height – gate opening = 89 ft + 6 ft – 1.02 ft).

Since the gates in gate group #1 are open air, they are always modeled as weir flow; however, the closed top overflow gate of gate group #2, can also be modeled as submerged orifice or sluice gate flow depending on the headwater and tailwater conditions. At the profile "Max WS" the closed top overflow gate is modeled as sluice gate flow. The user can determine that the gate flow in this example is being modeled as sluice gate flow by:

1. Evaluating whether the *Gate Area* field, which is the flow area in an open gate, is equal to the area of the gate opening ( $Gate\ Open\ Ht * Gate\ Width$ ). *This implies that the gate is flowing at full capacity.*
2. Checking whether the water surface elevation (95.28 ft) is above the top of the gate (92 ft).
3. The tailwater elevation (85.21 ft at RS 200) is well below the invert elevation of the gate (91.98 ft at this particular profile). If the gate reached a submergence of 67% (see **Hydraulic Reference Manual**, Chapter 8 for how this is calculated) the program would begin to transition to the fully submerged Orifice equation.



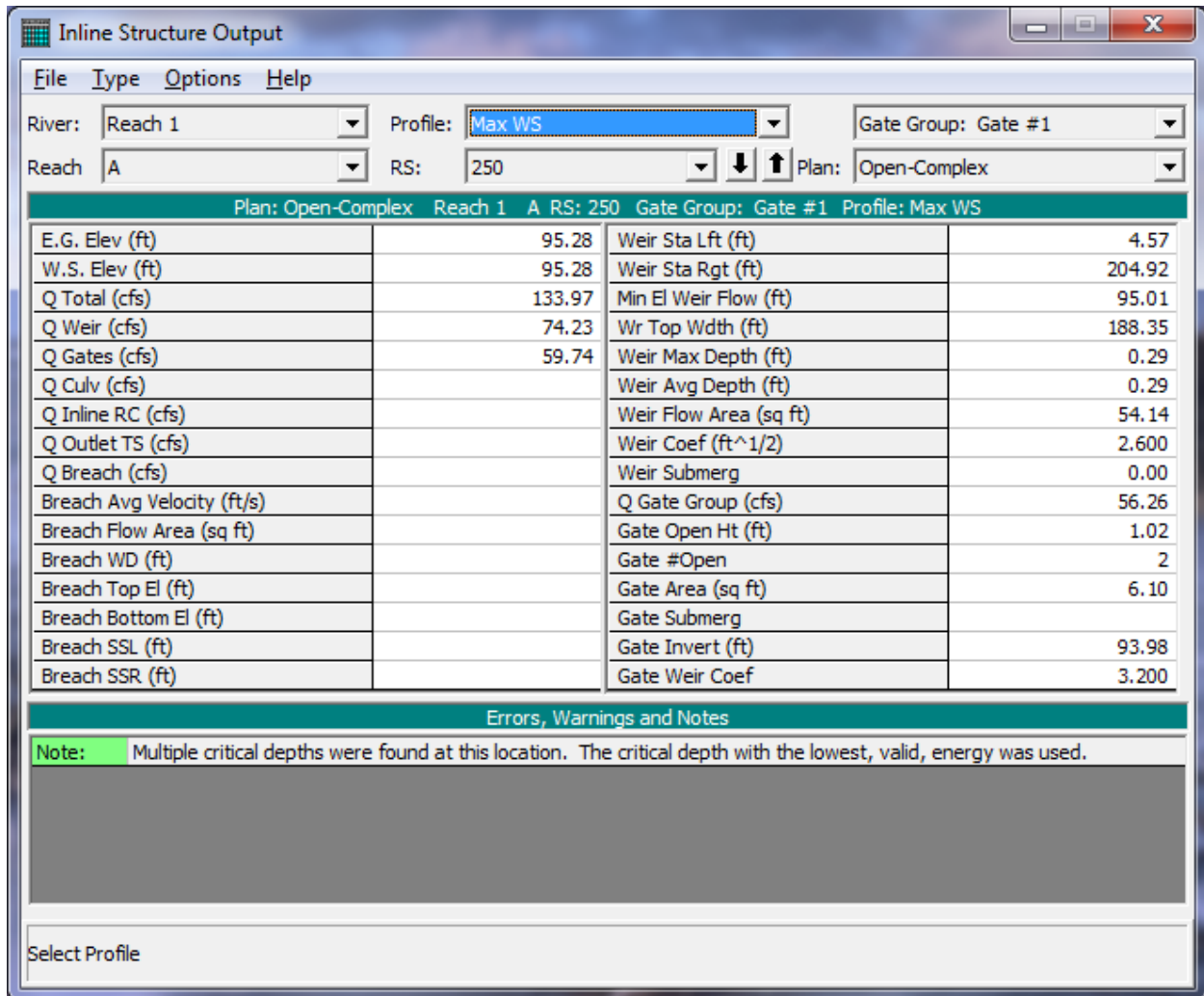

Figure 21-19. Inline Structure Output Table for Max WS

### Profile Summary Table

The Profile Summary Table is beneficial when the user wants to evaluate and compare several profiles at once. The **Lateral Structure Profile Summary Table** is shown in Figure 21.20. This figure was activated from the main program window by selecting **View, Profile Table, Std. Tables**, and then **Lateral Structure**. The Inline Structure Profile Table and the Storage Area Profile Table can also be selected in this same manner. However, the storage area connection does not have a profile table (although the net flux out of/into the storage area can be viewed in the Storage Area Profile Table).

The table displays the water surface elevations, energy grade line, and total weir and gate flows for each of the profiles. This table shows that weir flow never occurred during the entire event, but water did pass through the

overflow gate. The maximum flow through the gate occurred at January 4th at 1300 hours at a rate of 34.78 cfs.

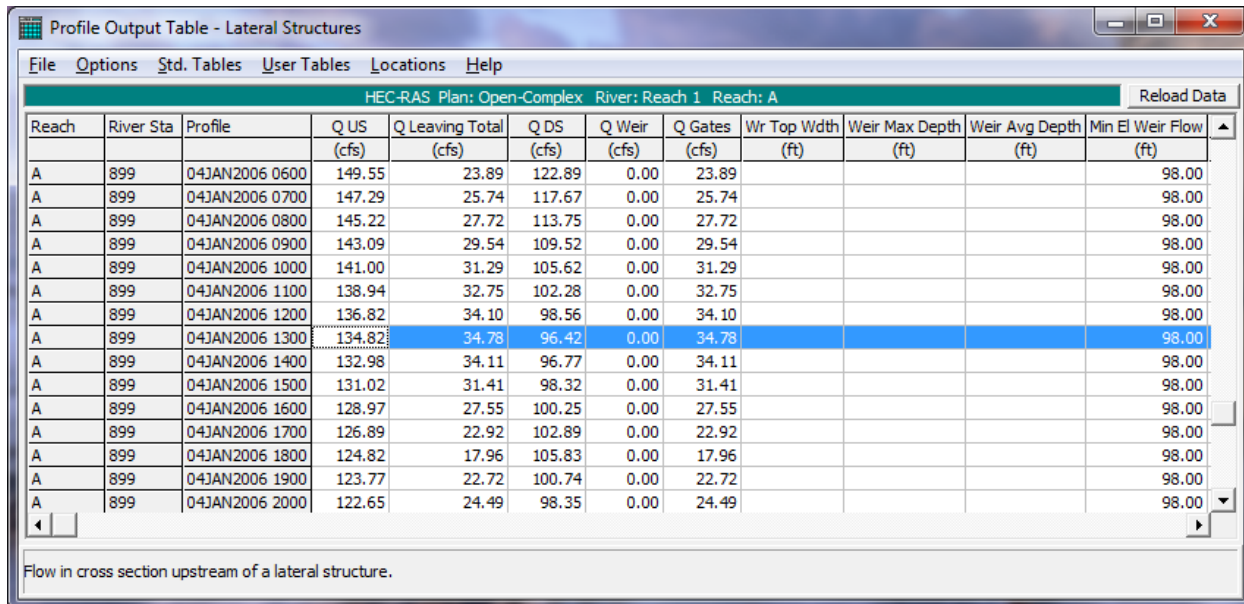

Reach	River Sta	Profile	Q US (cfs)	Q Leaving Total (cfs)	Q DS (cfs)	Q Weir (cfs)	Q Gates (cfs)	Wr Top Wdth (ft)	Weir Max Depth (ft)	Weir Avg Depth (ft)	Min El Weir Flow (ft)
A	899	04JAN2006 0600	149.55	23.89	122.89	0.00	23.89				98.00
A	899	04JAN2006 0700	147.29	25.74	117.67	0.00	25.74				98.00
A	899	04JAN2006 0800	145.22	27.72	113.75	0.00	27.72				98.00
A	899	04JAN2006 0900	143.09	29.54	109.52	0.00	29.54				98.00
A	899	04JAN2006 1000	141.00	31.29	105.62	0.00	31.29				98.00
A	899	04JAN2006 1100	138.94	32.75	102.28	0.00	32.75				98.00
A	899	04JAN2006 1200	136.82	34.10	98.56	0.00	34.10				98.00
A	899	04JAN2006 1300	134.82	34.78	96.42	0.00	34.78				98.00
A	899	04JAN2006 1400	132.98	34.11	96.77	0.00	34.11				98.00
A	899	04JAN2006 1500	131.02	31.41	98.32	0.00	31.41				98.00
A	899	04JAN2006 1600	128.97	27.55	100.25	0.00	27.55				98.00
A	899	04JAN2006 1700	126.89	22.92	102.89	0.00	22.92				98.00
A	899	04JAN2006 1800	124.82	17.96	105.83	0.00	17.96				98.00
A	899	04JAN2006 1900	123.77	22.72	100.74	0.00	22.72				98.00
A	899	04JAN2006 2000	122.65	24.49	98.35	0.00	24.49				98.00

Figure 21-20. Lateral Structure Profile Output Table

## Summary

This unsteady flow example consisted of a relatively complex system which included a storage area connection (connecting two storage areas), lateral weir, and inline structure – all utilized the overflow gate feature. While all of the gates modeled were overflow gates, one of the inline structure’s gates was closed top while the remaining gates were open air. The modeler was instructed on how to setup the gates and where to review the output results.

By reviewing the water surface profiles and the output tables, the user can determine the type of flow through the gate openings and determine if adjustments to the gate settings are required to provide for a selected water surface elevation. The **Detailed Output** table provides detailed output for each gate group, for any profile. The **Profile Summary Output Table** provides upstream energy and water surface elevations along with the total weir and gate flow.

## CHAPTER 22

# Groundwater Interflow

## Purpose

This example focuses on the groundwater interflow boundary condition and how it can be applied within an unsteady hydraulic model. The HEC-RAS program employs Darcy's equation to represent the interplay between the surface water levels and groundwater flow. This method is merely a simplified approximation of the complex interactions between surface water and groundwater; however, for many models the level of accuracy provided by this feature is sufficient.

To activate the data files for this project, from the main HEC-RAS window, select **File** and then **Open Project**. Go to the directory in which you have installed the HEC-RAS example data sets. From the "**Applications Guide\Chapter 22 – Groundwater Interflow**" subdirectory, select the project labeled "**Groundwater Interact Test**". This will open the project and activate the following files:

Plan:	"Groundwater Interaction Run"
Geometry:	"Groundwater Geometry"
Flow:	"GW Unsteady Flow"

## Geometric Data

To perform the analysis, the geometric data was entered first. This data consists of the river system schematic, the cross section geometry, storage areas, and lateral structures. Each of these geometric data components are briefly described in the following sections.

### River System Schematic

From the main program window, select **Edit** and then **Geometric Data**. This will display the river system schematic as shown in Figure 22.1. The river schematic consists of two rivers – Butte Creek and Fall River – that converge at Sutter Junction. The junction data was entered in the **Junction Data Editor** (which was selected from the **Geometric Data Editor**) as seen in Figure 22.2. There are a total of 20 cross sections entered along the three



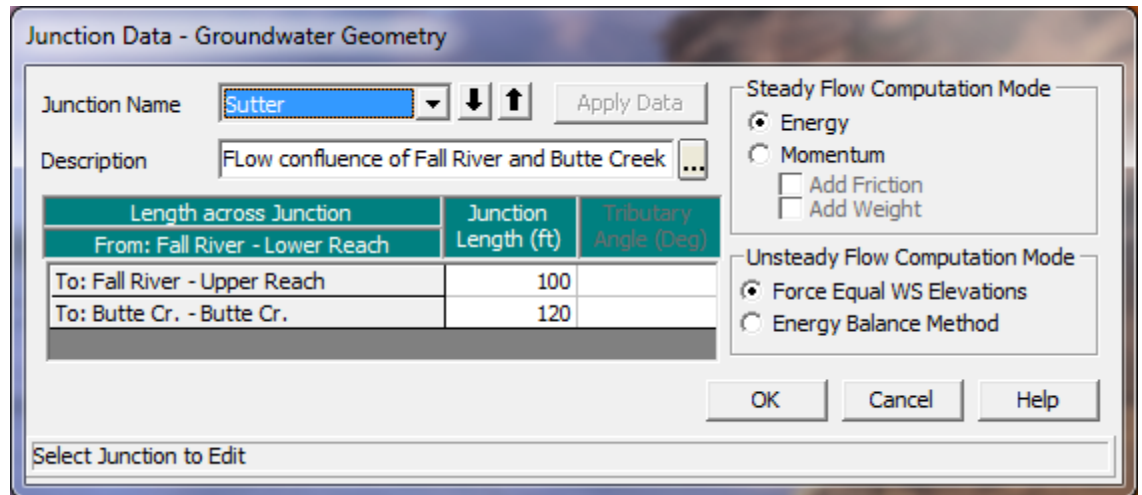

Figure 22-2. Junction Data Editor

## Cross Section Geometry

The cross section geometry consists of the cross section X-Y coordinates, reach lengths, Manning's n values, main channel bank stations, contraction and expansion coefficients, etc. The user can view this data for each river station by selecting the **Cross Section** icon on the left side of the **Geometric Data Editor**.

## Creating Storage Areas

On the **Tools** toolbar in the **Geometric Data Editor** the icon for **Storage Area** was selected. The pointer was then placed west of Fall River Upper Reach and the storage area was drawn by single clicking and dragging the mouse for each desired point for the storage area. The final point for the storage area was selected by double clicking the mouse. Upon double clicking the mouse, a dialog box appears requesting a storage area name. The name "Upper Pond" was entered. Points on a storage area may be added or removed by using the **Add Points** to a Reach or SA and **Remove Points** to a Reach or SA options found in the **Edit** menu. Lower Pond was created in a similar manner. The hydraulic connections for each storage area are discussed in subsequent sections.

## Entering Data for a Storage Area

After the storage area was drawn in the **Geometric Data Editor** the surface area for storage was entered. The data was entered in the **Storage Area Editor**, displayed in Figure 22.3, found by selecting the **Storage Area** icon on the **Editors** toolbar. Upper Pond and Lower Pond both used the **Area times depth method**. An area of 50 acres with a minimum elevation of 70

feet was entered for Upper Pond, while an area of 60 acres with a minimum elevation of 68 feet was entered for Lower Pond. This method computes the product of a constant area and change in water surface elevation to calculate storage volume.

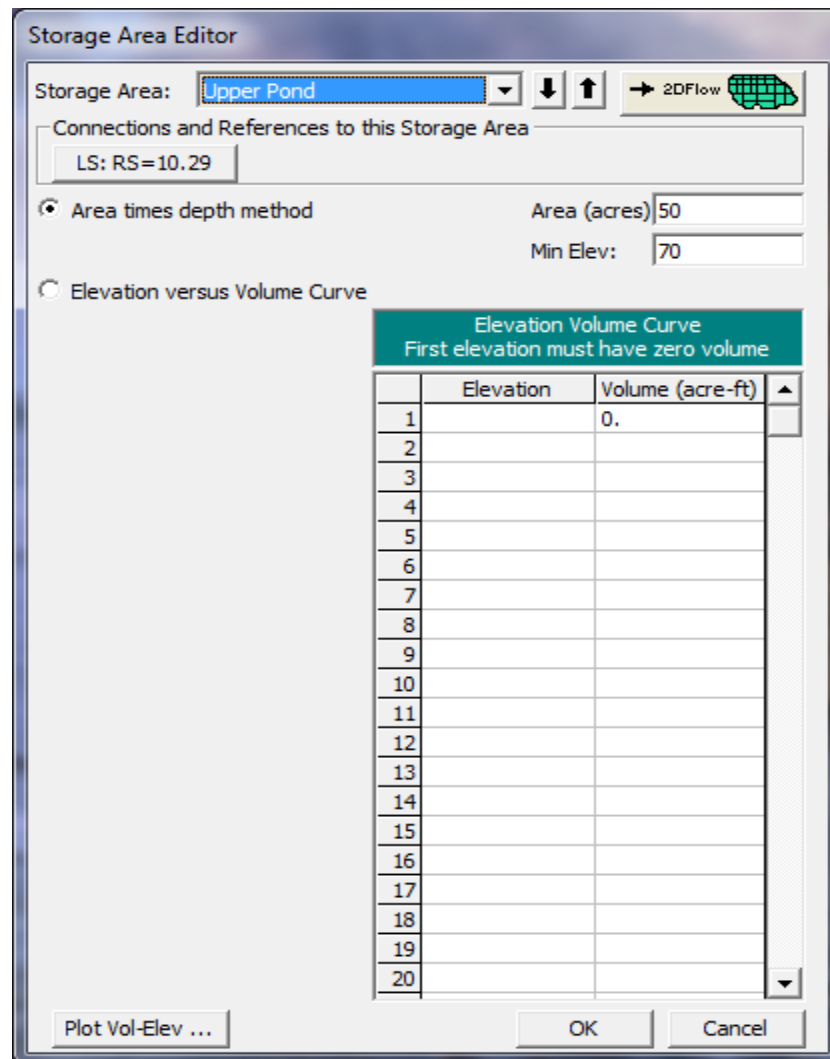

Figure 22-3. Storage Area Editor for Upper Pond

### Lateral Structure Connected to a Storage Area

A lateral structure was placed on the Upper Reach and Lower Reach portions of Fall River by selecting the **Lateral Structure** icon from the **Editors** toolbar in the **Geometric Data Editor**. After selecting the icon, the **Lateral Structure Data Editor** appears, as shown in Figure 22.4. The lateral weir for

the Upper Reach was added first and then the Lower Reach's lateral structure was added in a similar manner. With the *River* and *Reach* dropdowns selected as "Fall River" and "Upper Reach", respectively, under the **Options** menu, **Add a Lateral Structure** was selected. The location of the structure was entered at 10.29. This placed the beginning of the structure between river stations 10.3 and 10.2.

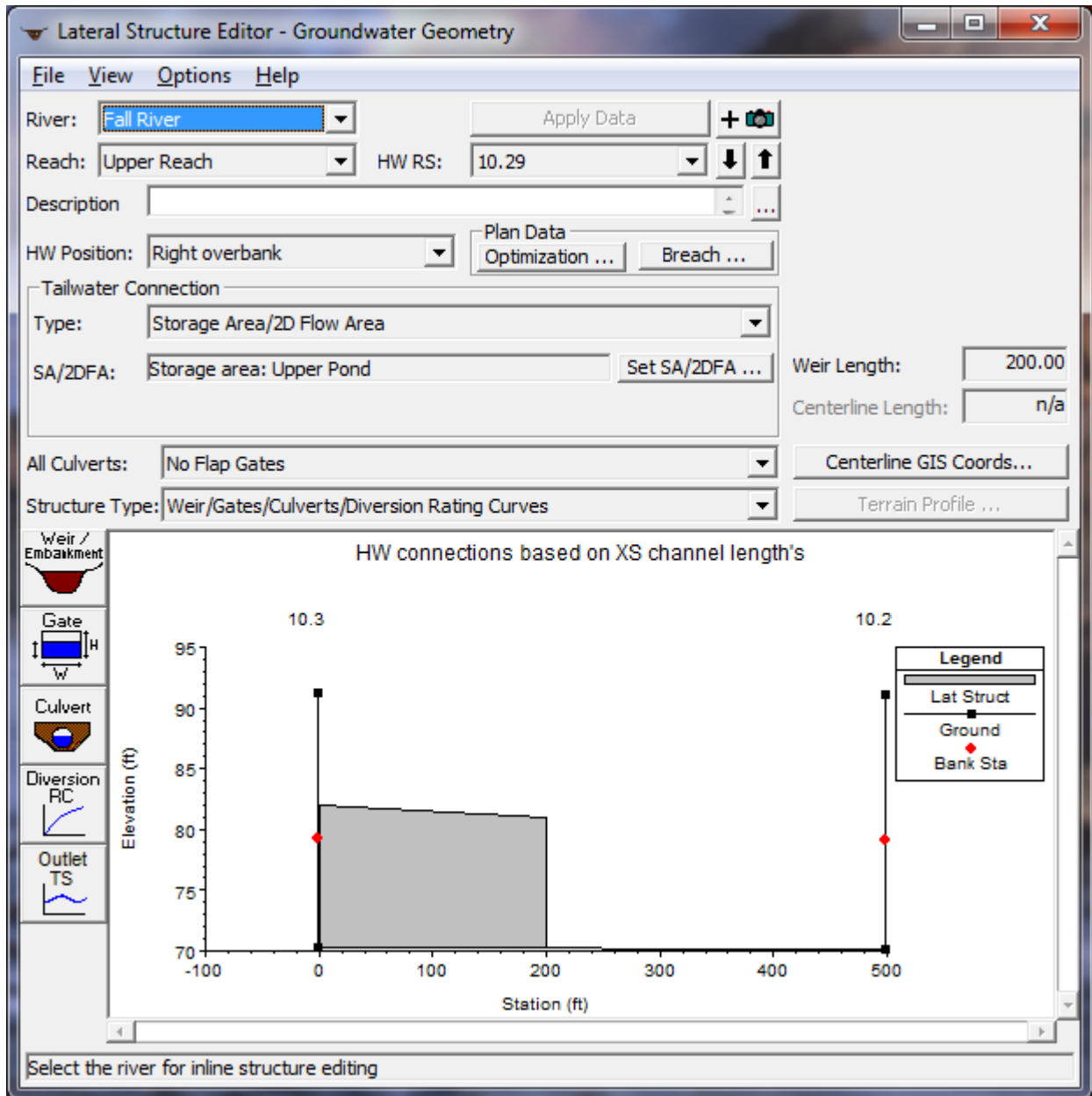

Figure 22-4. Lateral Structure Editor

To enter data for the structure, the **Weir/Embankment** icon was selected from the **Lateral Structure Data Editor**. The data was entered as shown in Figure 22.5 on the **Lateral Weir Embankment Window**. The weir is broad crested with a width of 20 feet, placed one foot from the upstream river station 10.3. The weir flow reference method was chosen as “water surface.”

Embankment Station/Elevation Table		
Weir Station and Elevation		
	Station	Elevation
1	0.	82.
2	200.	81.
3		
4		
5		
6		
7		
8		
9		
10		
11		
12		
13		
14		
15		
16		
17		
18		
19		
20		
21		
22		

Figure 22-5. Lateral Weir Embankment Editor for lateral weir on Upper Reach

Returning to the **Lateral Structure Data Editor**, the “Right overbank” was selected from the pull-down *HW Position* menu. Lastly, a connection was made to the storage area by selecting the **Set SA** button. A window then popped up, allowing the user to select a storage area to connect to. On the pull-down menu “Upper Pond” was selected.

## Unsteady Flow Data

The user is required to enter boundary conditions and initial conditions for the system at the beginning of the simulation period. For additional information on unsteady flow data refer to Chapter 8 of the User’s Manual, Performing an



Unsteady Flow Analysis. The **Unsteady Flow Data Editor**, shown in Figure 22.6, was selected from the main program window under the **Edit** menu.

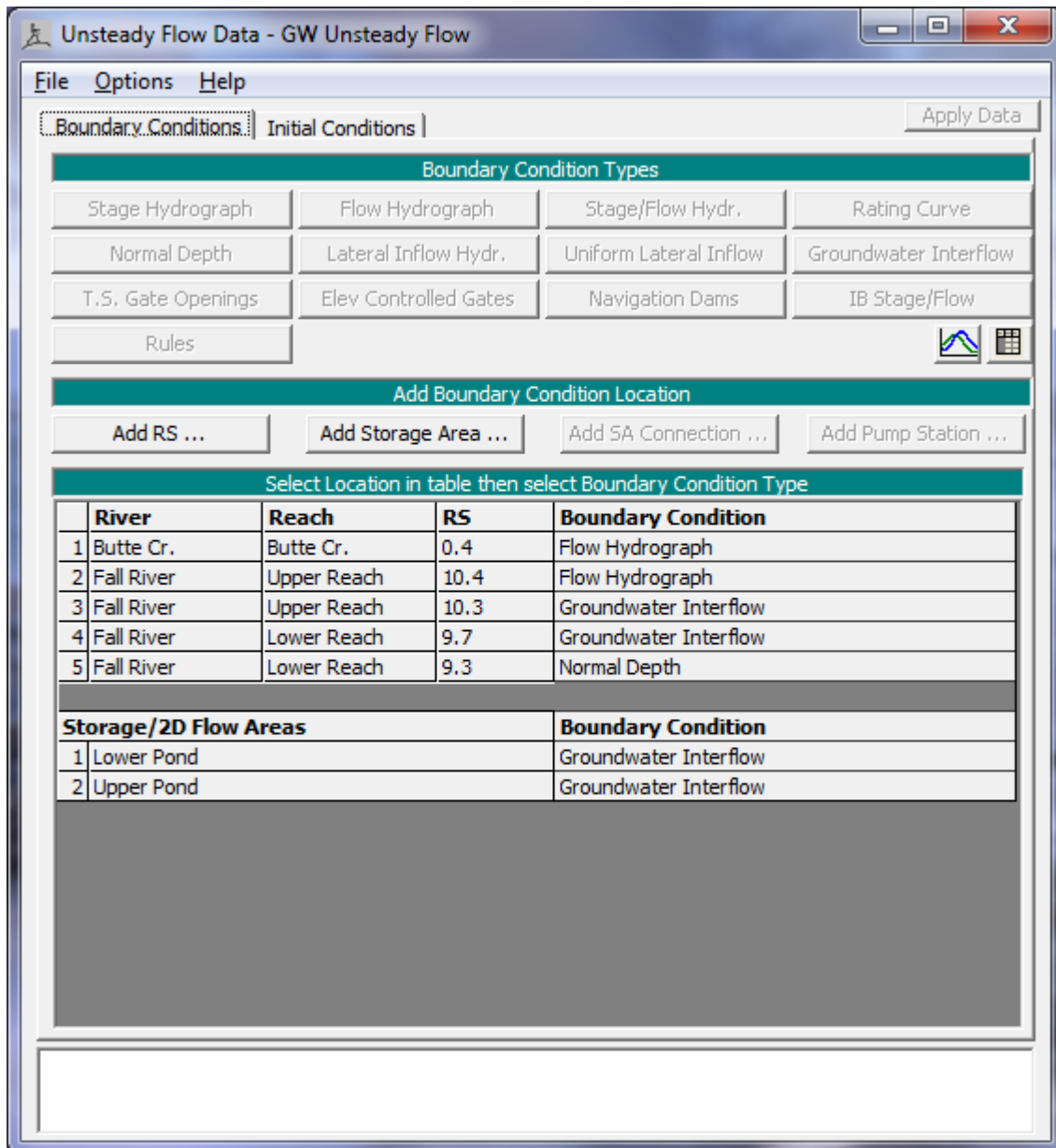

Figure 22-6. Unsteady Flow Data Editor

### Boundary Conditions

Boundary conditions are required for the furthest upstream and downstream cross sections. Upon entering the **Unsteady Flow Data Editor** the furthest upstream and downstream cross sections will be located in the boundary

conditions column. In this case, the user will see River Station 10.4 on Upper Reach and River Station 0.4 on Butte Creek as the upstream boundary conditions and River Station 9.3 of Lower Reach as the downstream boundary condition. Boundary conditions are set by highlighting the adjacent cell under **Boundary Condition Type**. When a cell is highlighted, not all boundary conditions are available. The program will automatically gray out all irrelevant boundary condition types. Internal boundary conditions may be added by selecting one of the buttons under the “Add Boundary Condition Location” heading.

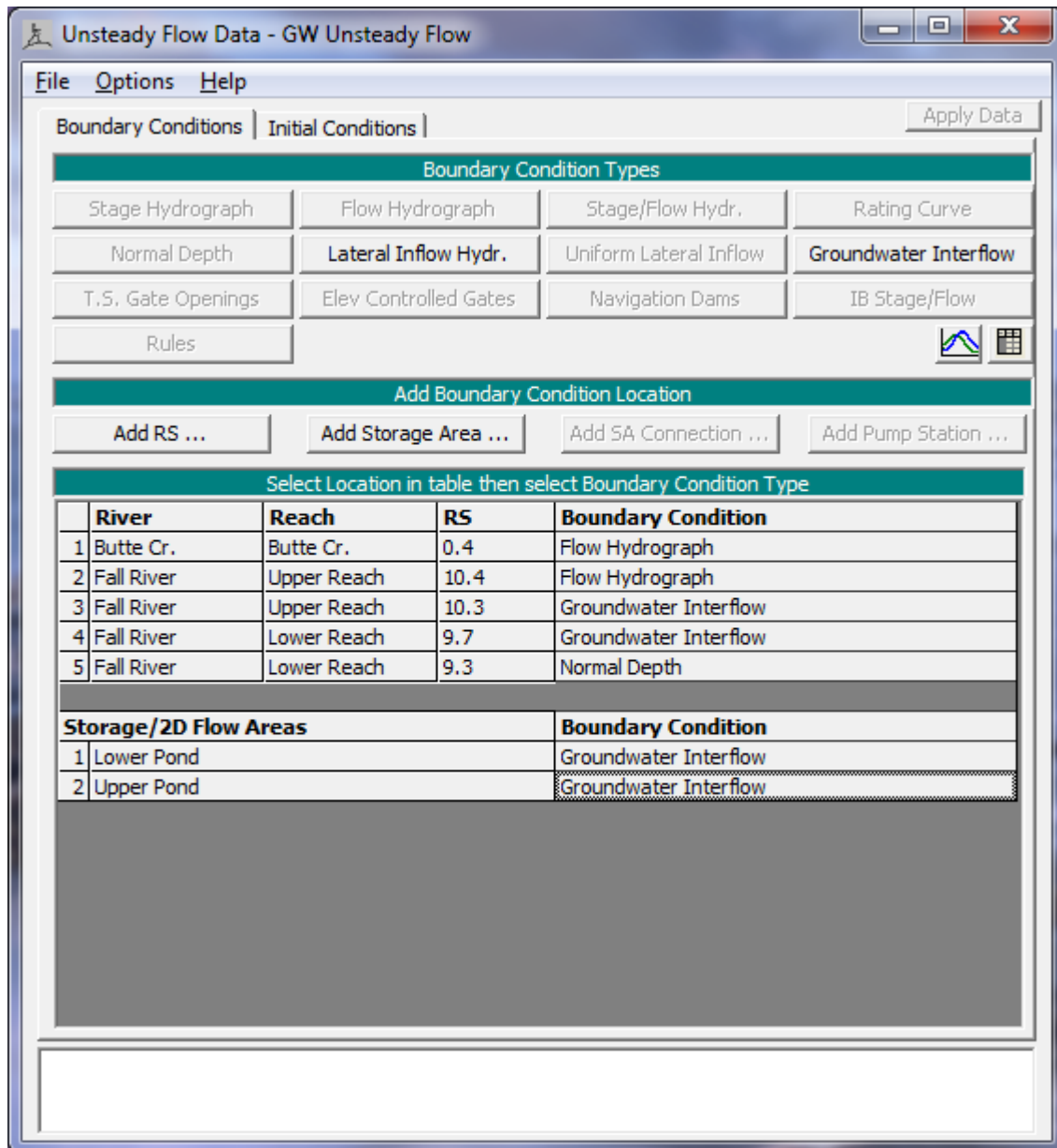

Figure 22-7. Unsteady Flow Data Editor

### Upstream Boundary Condition

An upstream boundary condition was required at River Stations 10.4 of Upper Reach and 0.4 of Butte Creek. For River Station 10.4 of Upper Reach a flow hydrograph was selected as the boundary condition by highlighting the cell and pressing the **Flow Hydrograph** button. The window for entering a **Flow Hydrograph** then appeared (Figure 22.8). For this example the flow hydrograph was manually entered by selecting the **Enter Table** radio button. The **Data Time Interval** was set to one hour and the radio button **Use Simulation Time** was selected. The **Use Simulation Time** option starts the hydrograph at the beginning of the simulation time window, which is discussed in an upcoming section. The hydrograph was then manually entered with a baseflow around 500 cfs and a floodwave that peaked at 3500 cfs. A flow hydrograph was entered at River Station 0.4 of Butte Creek in the same manner.

Figure 22-8. Flow Hydrograph for Upstream Boundary Condition

## Downstream Boundary Condition

For River Station 9.3 of Lower Reach the boundary condition selected was normal depth. Again, the corresponding cell for that particular river station was highlighted and the **Normal Depth** button was selected. The window shown in Figure 22.9 was then displayed and a value of 0.0004 was entered as the friction slope. The slope of the water surface is often a good estimate of the friction slope.

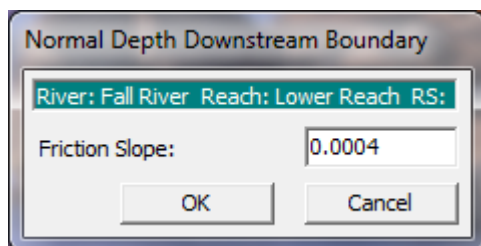

Figure 22-9. Normal Depth for Downstream Boundary

## Groundwater Interflow (Internal Boundary Condition)

In this example the groundwater interflow boundary condition is applied to a section of the Upper Reach (RS 10.3 to 9.9) and Lower Reach (RS 9.7 to 9.4), as well as both storage areas. The groundwater interflow feature uses Darcy's equation to model the flow of groundwater into, or out of, a reach or a storage area, depending on the water surface head.

To enter a new boundary condition for the reaches, **Add RS** from the **Unsteady Flow Data** window was selected and then the desired river station location was selected. Once the desired river station was selected and appeared in the *Selected Locations* box, the **OK** button was clicked. This was done for both RS 10.3 and RS 9.7 and the selected RS locations were populated in the Boundary Conditions Table (as seen in Figure 22.7). The corresponding cell next to the river station number was highlighted under the *Boundary Condition* column and the **Groundwater Interflow** button was selected.

Upon selecting *Groundwater Interflow* as the boundary condition a window opens up titled "Groundwater Interflow" (Figure 22.10). At the top of the window, the user selects the river stations that the interflow will be between. The upstream river station is the one picked from the *Unsteady Flow Data Editor* earlier, while the downstream value is selected from a dropdown menu. For this example, the river stations corresponding to RS 10.3 and RS 9.7 were RS 9.9 and RS 9.4, respectively. Next, the radio button **Enter Table** was selected. The *Data time interval* dropdown was kept at the default of 1 Hour. Under *Select/Enter the Data's Starting Time Reference* the **Use Simulation Time** radio button was selected, automatically filling in the *Date* and *Time* fields. The groundwater stage was then entered for each time step.

**Groundwater Interflow**

River: Fall River Reach: Upper Reach RS: 10.3 to 9.9

Interflow will be between RS:10.3 to RS:

Read from DSS before simulation

File:

Path:

Enter Table Data time interval:

Select/Enter the Data's Starting Time Reference

Use Simulation Time: Date:  Time:

Fixed Start Time: Date:  Time:

Hydrograph Data			
	Date	Simulation Time (hours)	Groundwater Stage (ft)
1	02Sep1998 2400	00:00	65.
2	03Sep1998 0100	01:00	65.04
3	03Sep1998 0200	02:00	65.08
4	03Sep1998 0300	03:00	65.12
5	03Sep1998 0400	04:00	65.16

Ground Water Interflow Parameters

Groundwater Interflow K (ft/day):

Thickness (or length) of GW Interflow (ft):

Min Flow:  Multiplier:

Figure 22-10. Groundwater Interflow Editor for RS 10.3 of Upper Reach

Darcy's equation requires a hydraulic conductivity (K) value, area, and a hydraulic gradient. The equation's area component is derived from the storage area or the reach's cross sectional geometry that it is referencing, while the other values are entered in the Groundwater Interflow Editor. In this example, a hydraulic conductivity of 3.6 ft/day was entered at the bottom of the window in the field **Groundwater Interflow K** for RS 10.3 to RS 9.9 and RS 9.7 to RS 9.4. Directly beneath this entry the **Thickness (or length) of GW Interflow** was entered as two feet for both river stations. The difference between the groundwater stage and the surface water stage at each time step is calculated and then divided by this value in order to determine the hydraulic gradient for each time step. Once all this data was entered, Darcy's equation had all the parameters it needed to determine if the groundwater was flowing into, out of, or was balanced with the surface water at each time step.

The same steps as outlined above were taken when adding the Groundwater Interflow boundary condition for the two storage areas with the exception that the button **Add Storage Area** was chosen as opposed to "Add RS" and the values entered were different. Once all the data was entered, the window was closed and the data was stored by clicking **OK**.

### **Initial Conditions**

Initial conditions consist of flow and stage information at each of the cross sections, as well as elevations for any storage areas defined in the system. Data for initial conditions are established by selecting the **Initial Conditions** tab on the **Unsteady Flow Data Editor**. After selecting the tab, Figure 22.11 will be displayed.

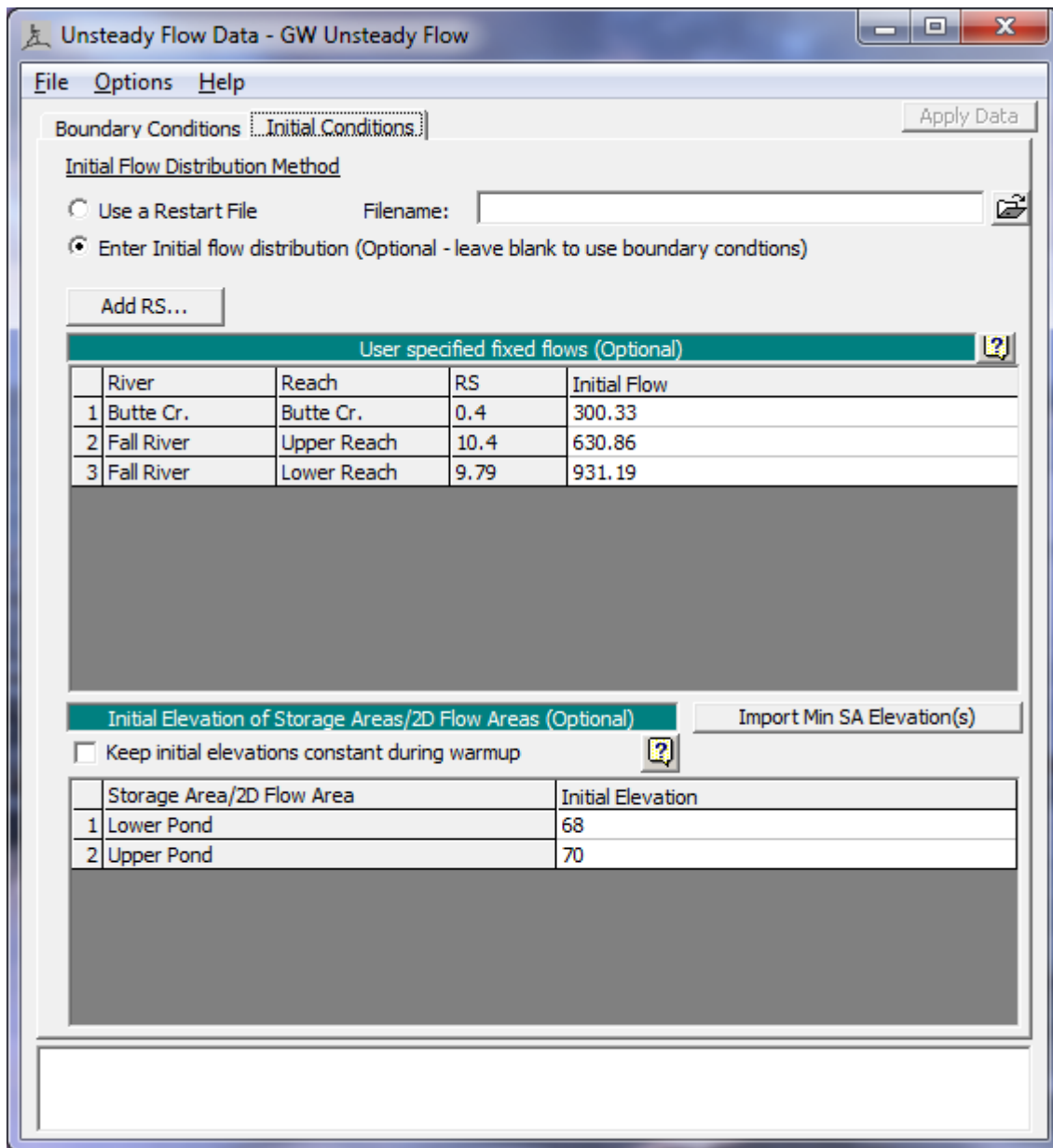

Figure 22-11. Unsteady Flow Data Initial Conditions

Flow data was entered for each reach so the program could perform a steady-flow backwater run to compute the corresponding stages at each cross section. As shown on Figure 22.11, the Upper Reach has an initial flow of 630.86 cfs and Butte Creek has an initial flow of 300.33 cfs. These two reaches converge at Fall River RS 9.79 and the resulting initial flow entered at this location is the summation of Upper Reach and Butte Creek initial flows (300.33 cfs + 630.86 cfs = 931.19 cfs).

In addition to flow data, the initial water surface elevation for each storage area is needed. Initial elevations were set to 68 and 70 feet for Lower Pond and Upper Pond, respectively. Since the bottoms of the storage areas were set to these same values in the Geometric Editor, this implies that the storage areas are dry at the beginning of the simulation. The data was then saved in the **Unsteady Flow Data Editor** and the window was closed.

## Unsteady Flow Analysis

After the geometry and unsteady flow data have been completed an unsteady flow analysis may be initiated. Under the main program window **Unsteady Flow Analysis** was selected under the **Run** menu. This displayed the **Unsteady Flow Analysis Window** shown in Figure 22.12. A plan was defined by selecting the Geometry File "Groundwater Geometry" and the Unsteady Flow File "GW Unsteady Flow." Under the **File** menu, **Save Plan As** was selected and the plan title was entered as "Groundwater Interaction Run." After entering the title of the plan a short identifier was entered as "GroundInteract" and the plan was saved.



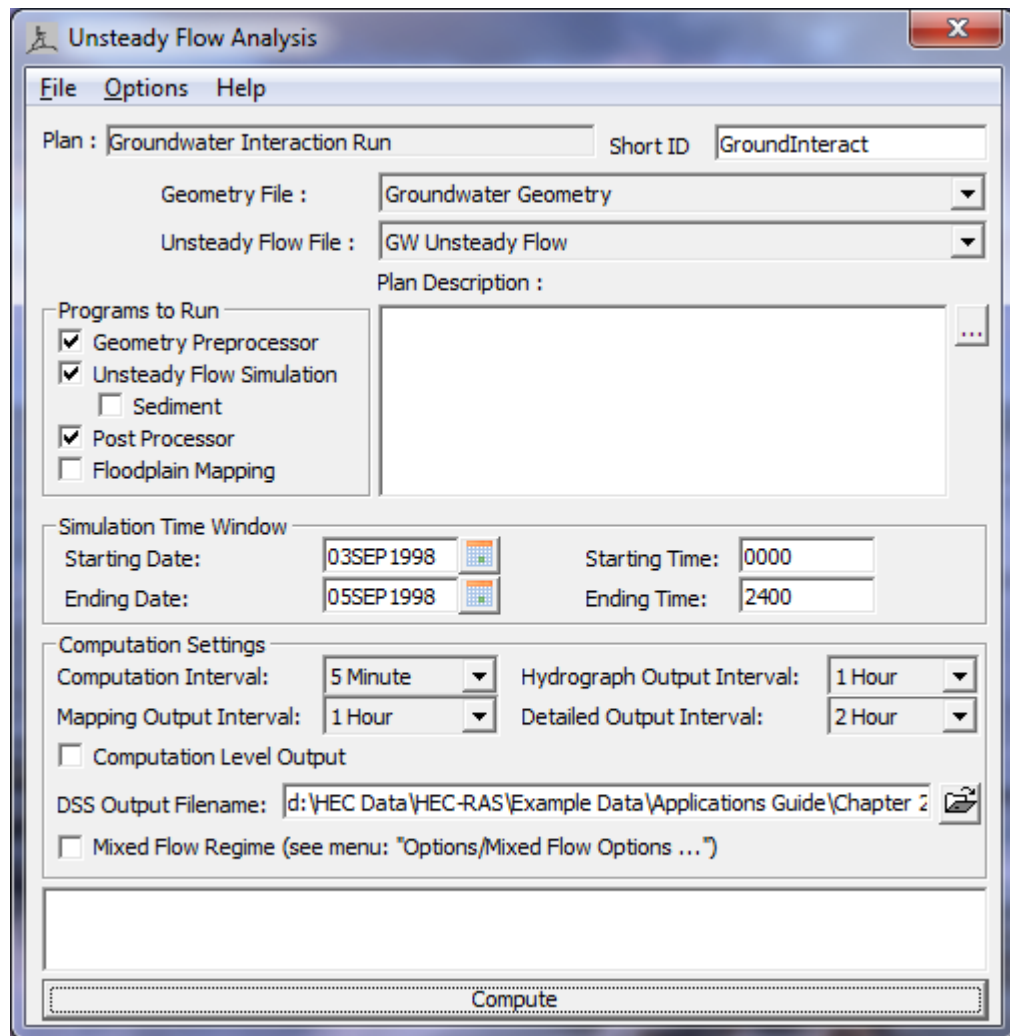

Figure 22-12. Unsteady Flow Analysis Window

## Simulation Time Window

The simulation time window, located on Figure 22.12, requires a beginning and ending date and time for simulation. The date must have a four digit year and was entered in the following format: 03SEP1998. The time field is entered in military time (i.e. 1 p.m. is entered as 1300). For this application the simulation time began and ended at 0000.

## Computation Settings

The computation settings in the **Unsteady Flow Analysis Window** contain the following: the computational interval; hydrograph output interval; instantaneous profiles interval; and the name and path of the output DSS file.

For this example the computation interval was set to 5 minutes. The computation interval should be small enough to accurately describe the rise and fall of the floodwave. The hydrograph output interval was set to 1 hour. This interval defines the output of computed stage and flow hydrographs written to HEC-DSS. The detailed output interval was set to 2 hours, specifying the interval at which detailed hydraulic output will be computed by the post processor. It is suggested that this interval remain fairly large to reduce the amount of post processing and storage required. An appropriate path was selected for the output to DSS.

## Programs to Run

There are three components used in performing an unsteady flow analysis within HEC-RAS: the geometric data preprocessor (HTAB); the unsteady flow simulator (UNET); and an output post processor. These three (plus Floodplain Mapping, which is not discussed in this application) can be found and turned on under the **Programs to Run** heading found on the Unsteady Flow Analysis window (see Figure 22.12).

The geometry pre-processor is used to speed up the unsteady flow calculations by processing the geometric data into a series of hydraulic property tables and rating curves. It is highly recommended that the user run the geometry pre-processor and examine hydraulic output for anomalies before running the unsteady flow simulator and the post-processor.

The unsteady flow simulation is what actually creates the stage and flow hydrographs. The program is a three step process that requires the tables from the geometry pre-processor, the boundary conditions, and flow data from the interface to operate.

The post processor is used to compute detailed hydraulic information for a set of user specified time lines during the unsteady flow simulation period. By running the post processor, the user will have all of the available plots and tables for unsteady flow that HEC-RAS normally produces for steady flow.

The **Geometry Preprocessor**, **Unsteady Flow Simulation**, and **Post Processor** were all checked on. More information can be found in *Example 17 Unsteady Flow Application*.

## Location of Stage and Flow Hydrographs

The user has the option of specifying locations to have hydrographs computed and available for display. The user may select individual cross sections, groups of cross sections, or entire reaches. From the **Options** menu on the **Unsteady Flow Analysis Window**, the **Stage and Flow Output Locations** option was selected, displaying Figure 22.13. For this example "All Reaches" was selected. This option will compute hydrographs at every cross section in the data set. If the user is working with an extremely large data set,

computation time and data storage can be reduced by only selecting the most essential cross sections for output.

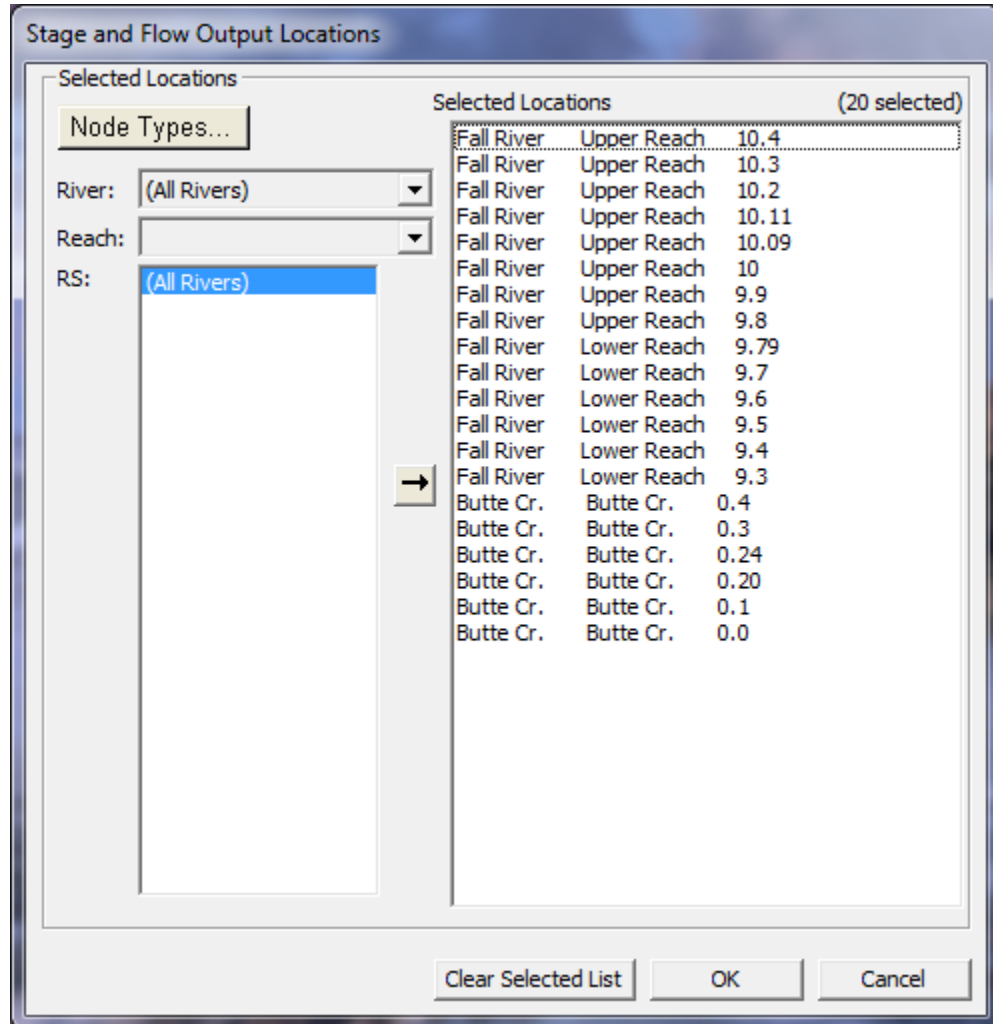

Figure 22-13. Stage and Flow Output Locations

### Flow Distribution Locations

By selecting **Flow Distribution Locations** - from the **Options** menu on the **Unsteady Flow Analysis Window** - the user can specify locations they would like the program to calculate flow distribution output. The flow distribution option allows the user to subdivide the left overbank, main channel, and right overbank, for the purpose of computing additional hydraulic information. Once selected, a window should appear titled *Set Locations for Flow Distribution* that looks like Figure 22.14. The field *Set*

*Global Subsections* was left alone because, for this example, it was not desired to compute flow distribution information for all the cross sections. A flow distribution was calculated at Fall River Lower Reach RS 9.6 by selecting these parameters from the corresponding fields under the *Set Specific Locations Subsection Distribution*. Next, the left overbank (LOB dropdown) was divided into two subsections, the channel into 10 subsections, and the right overbank (ROB dropdown) into two subsections. Once all the parameters were entered, the **Set Selected Range** was clicked, which populated the blank field below. **OK** was selected and all the changes were saved.

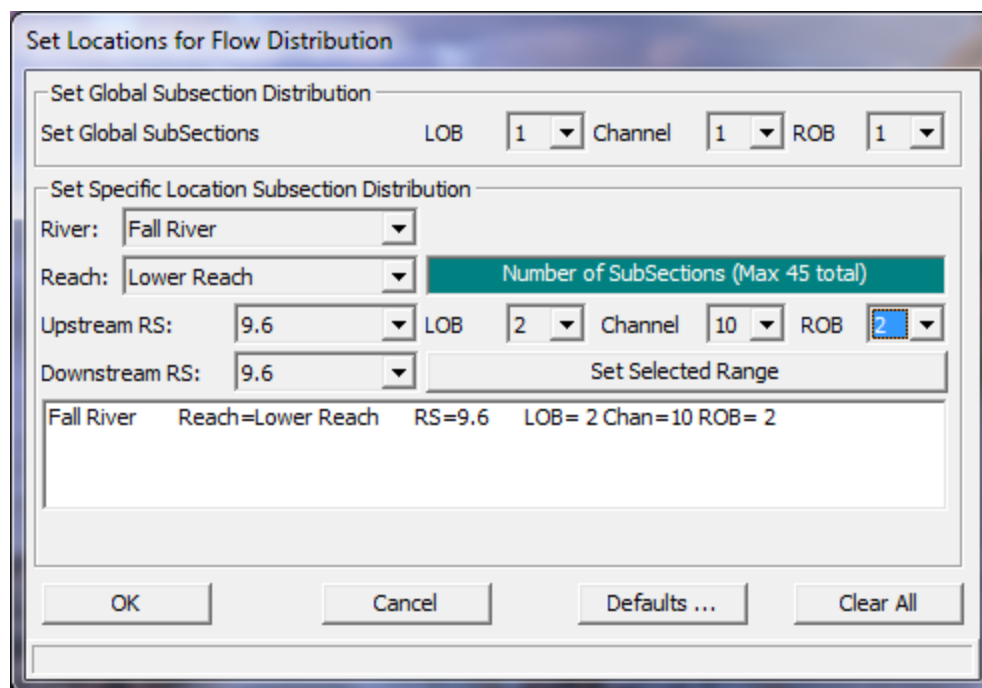

Figure 22-14. Set Locations for Flow Distribution Window

## Output Analysis

### Stage and Flow Hydrographs

The output from the simulation can be viewed from many different tables and graphs. However, pertinent information on the groundwater flow is best illustrated through viewing the stage and flow hydrographs. From the main program window, **View** and then **Stage and Flow Hydrograph** was selected. By selecting the **Type** menu on the **Stage and Flow Hydrograph Window** the user can view stage and flow hydrographs for the groundwater interaction by selecting **Ground Water Interaction**.

Once selected, a window appeared showing the stage and flow hydrographs for one of the four groundwater interaction locations (Figure 22.15). From the GW dropdown menu, the "Storage Area: Upper Pond" was selected and its stage and flow hydrographs appeared below it (as seen in Figure 22.15). The other three groundwater interflow locations can be viewed by selecting them from the same dropdown menu.

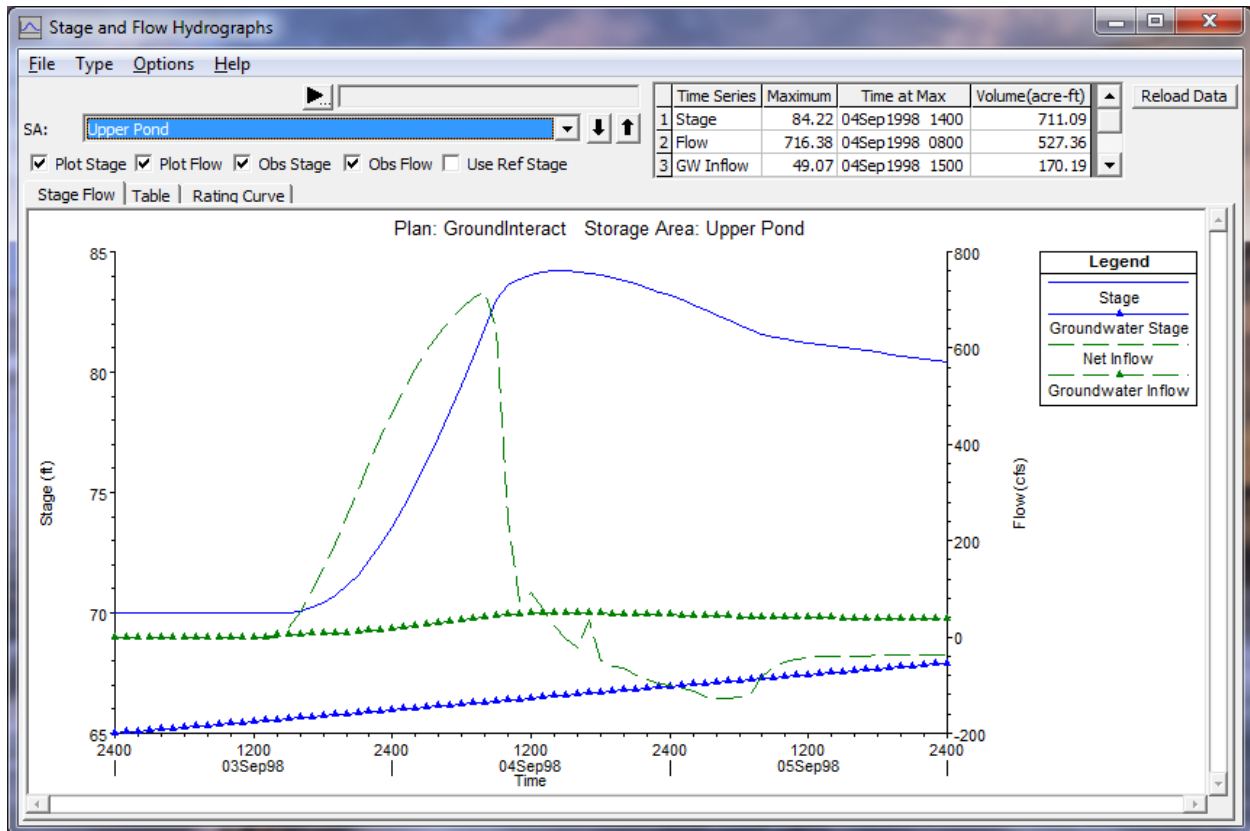

Figure 22-15. Stage and Flow Hydrograph for Upper Pond

As seen in Figure 22.15, the storage area stage begins to increase once the excess river flow of Upper Reach is diverted through the lateral structure. The storage area has a peak stage of 84.23 feet on September 4<sup>th</sup> at 1400 hours. Subsequently, the storage area's stage can be seen to decrease due to groundwater losses and flow entering back into Upper Reach.

Initially, there was no groundwater flow between the storage area and the groundwater reservoir because the storage area was dry at the beginning of the simulation and the groundwater level was well below the initial elevation of Upper Pond (the SA elevation was 70 ft; while the GW elevation was 65 ft). Since the storage area had no water to transfer and the groundwater couldn't flow up gradient, the *Groundwater Inflow* curve on both the graph and table shows a value of zero until water begins to fill the storage area. The groundwater inflow reached its peak (49.08 cfs) on September 4<sup>th</sup> at 1500 hours when the hydraulic gradient between the two was the steepest.

## DSS Plot

From the main program window, **View** and then **DSS Data** was selected, causing the window in Figure 22.16 to appear. Under Part C, the four cells titled “Flow-Groundwater Inflow” were selected (row numbers 201, 308, 317, & 321). These cells and their corresponding rows represent the data for the groundwater interflow hydrographs. By clicking each of the four rows, the program lists them in a field at the bottom of the window (see bottom of Figure 22.16). Once the values were populated in the field, the **Plot/Tabulate Selected Pathname(s)** was clicked. A new window titled **DSS Plot** appeared showing all four of the groundwater flow hydrographs as seen in Figure 22.17.

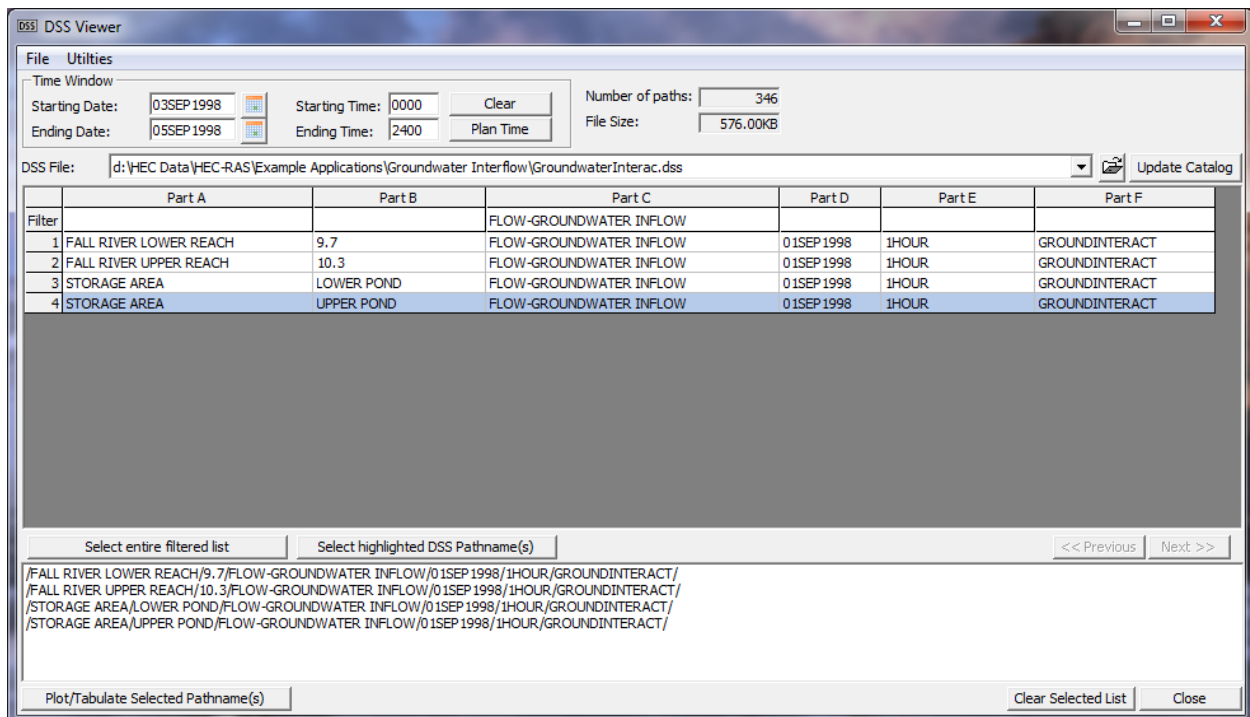

Figure 22-16. DSS Viewer

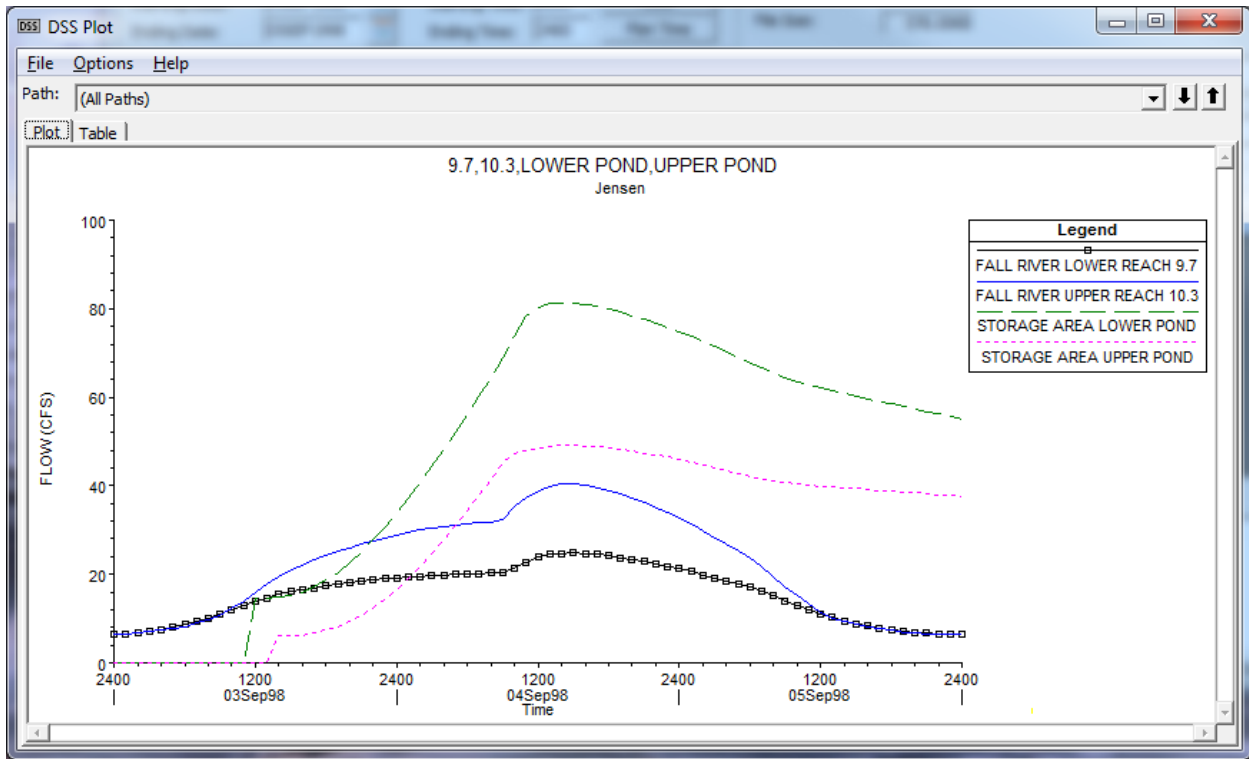

Figure 22-17. DSS Plot of Groundwater Interflow Hydrographs

## Summary

This unsteady flow example applies the groundwater interflow boundary condition to multiple reach and storage area locations. The program uses Darcy's equation to calculate the interchange between the surface waters and the groundwater. The user is shown how to input all necessary parameters and where to find the appropriate output data.





## CHAPTER 23

## Urban Modeling

### Purpose

This example will demonstrate the use of HEC-RAS to analyze many features often found in urban models, namely, pressurized pipe flow. Subsidiary topics discussed in this example are: how to model pipe connections, drop inlets, minor losses, levee breaches, pump stations, and storage areas. The model used in this example is a portion of a New Orleans Parish system. ***While the data is from actual studies, the model and the results of this example application do not represent current or future conditions of the system.***

Although modeling pressurized pipe flow in HEC-RAS is suitable for most projects, the user should be aware of its limitations. First, drop inlets are modeled in HEC-RAS by using lateral structures or a lateral inflow hydrograph; although this is suitable for some models, it does not fully capture all the details associated with drop inlet structures. Also, modeling pipe junctions with HEC-RAS should be done with caution because although it mimics the energy lost through the junction, its results are general and don't account for many of the details associated with modeling pipe junctions. The modeler is referred to Chapter 16 of the User's Manual and Chapter 4 of the Hydraulic Reference Manual for further discussion and an overview of the hydraulic computations for pressurized pipe flow.

To review the data files for this example, from the main HEC-RAS window, select **File** and then **Open Project**. Go to the directory in which you have installed the HEC-RAS example data sets. From the "Applications Guide\Chapter 23 – Urban Modeling" subdirectory, there will be a project titled "Orleans Parish Example Model." Once opened, this will activate the following files:

Plan:	"Katrina Existing Conditions"
Geometry:	"Orleans Parish – Existing Conditions"
Flow:	"Katrina Event"

### Geometric Data

To view the geometric data for the river system, from the main program window select **Edit** and then **Geometric Data**. This will activate the

**Geometric Data Editor** and display the river system schematic as shown in Figure 23.1. The schematic gives a visual representation of the geometric elements entered by the user.

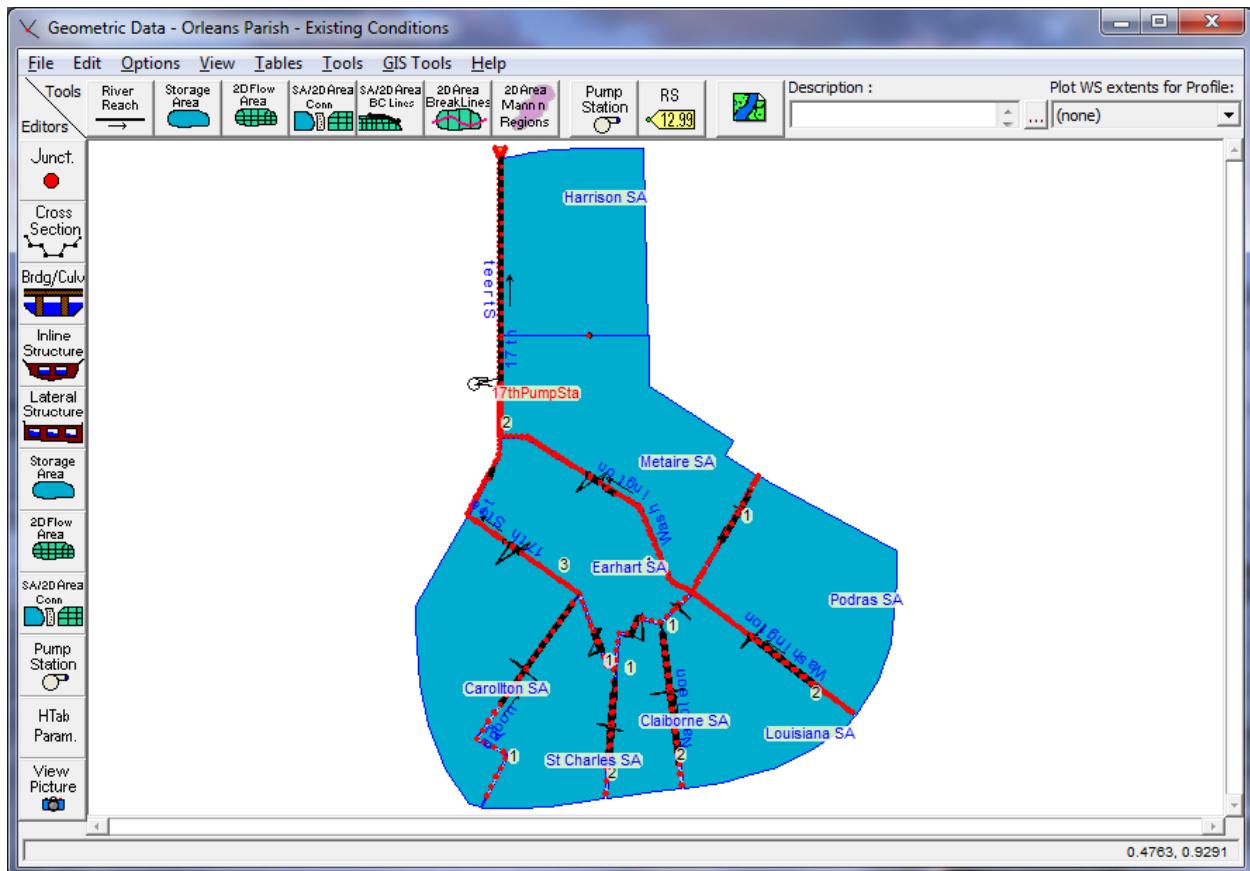

Figure 23-1. River System Schematic for New Orleans Parish System shown within the Geometric Data Editor

## Subsurface Modeling

The subsurface portion of this urban area was modeled with cross sections with lids in order to represent the pressurized pipe system. The pressurized pipe system is directly connected to open channel flow reaches. Additionally, there are several pump stations being modeled, as wells as pipe junctions and bends.

## Cross Section Data

The cross section data consists of the X-Y coordinates, Manning's n values, contraction and expansion coefficients, etc. The user can view this data for each river station by selecting the **Cross Section** icon on the left side of the **Geometric Data Editor**. Several of the cross sections were interpolated by selecting **XS Interpolation** from the **Tools** menu on the **Geometric Data Editor**.

Open air cross sections were transformed to pressurized pipes by adding a lid to the top of the cross sections. The "pipe" was formed with the cross section as the bottom half of the pipe and the Lid as the top half. This is done by selecting **Options** and then **Add a Lid to XS** from the **Cross Section Data Editor**. A table (as shown in Figure 23.2) will open and the high and low chord elevations and their corresponding station will be entered for each cross section's lid. The lid will be drawn on the cross section diagram of the *Cross Section Data Editor* once it has been entered and applied.

	Station	High El.	Low El.
1	0.	20.	0.
2	9.	20.	1.
3	9.	20.	19.
4	10.	20.	19.
5	10.	20.	1.
6	20.	20.	0.
7			
8			
9			
10			
11			
12			
13			
14			
15			

Figure 23-2. Table for entering a cross section's lid coordinates

Unsteady flow models, such as this one, require that the **Add a Preissmann Slot** be checked on. The Preissman Slot option can be turned on from each lidded cross section's editor (e.g. Figure 23.2) or from a table that shows the locations of all lidded cross sections. This comprehensive table can be viewed

by selecting **Priessmann's Slot on Lidded XS's** from the **Tables** menu on the **Geometric Data Editor**. The table is shown in Figure 23.3. For more information on Priessmann Slot Theory, the user is encouraged to review Chapter 16 of the User's Manual and Chapter 4 of the Hydraulic Reference Manual.

Check for a Priessmann's Slot to be added to XS's with a lid				
	River	Reach	RS	Add Priessmann Slot
1	17th Street	3	36020	<input checked="" type="checkbox"/>
2	17th Street	3	35819.8*	<input checked="" type="checkbox"/>
3	17th Street	3	35619.6*	<input checked="" type="checkbox"/>
4	17th Street	3	35419.4*	<input checked="" type="checkbox"/>
5	17th Street	3	35219.2*	<input checked="" type="checkbox"/>
6	17th Street	3	35019.*	<input checked="" type="checkbox"/>
7	17th Street	3	34818.8*	<input checked="" type="checkbox"/>
8	17th Street	3	34618.6*	<input checked="" type="checkbox"/>
9	17th Street	3	34418.4*	<input checked="" type="checkbox"/>
10	17th Street	3	34218.2*	<input checked="" type="checkbox"/>
11	17th Street	3	34018.*	<input checked="" type="checkbox"/>
12	17th Street	3	33817.8*	<input checked="" type="checkbox"/>
13	17th Street	3	33617.6*	<input checked="" type="checkbox"/>
14	17th Street	3	33417.4*	<input checked="" type="checkbox"/>
15	17th Street	3	33217.2*	<input checked="" type="checkbox"/>
16	17th Street	3	33017.*	<input checked="" type="checkbox"/>
17	17th Street	3	32816.8*	<input checked="" type="checkbox"/>
18	17th Street	3	32616.6*	<input checked="" type="checkbox"/>

Figure 23-3. Priessmann's Slot Table

### Minor Losses

Minor losses due to bends can be accounted for in HEC-RAS by selecting the **Minor Losses** feature from the **Tools** dropdown in the **Geometric Data Editor**. The *Minor Loss Coefficient Editor* can be seen in Figure 23.4. A K loss coefficient is required around each bend. The K loss coefficient can vary from 0.0 to 1.0, although the values for bends are usually closer to zero since bend losses typically cause relatively small losses. In this example, each bend's loss value was distributed amongst the bend's surrounding cross sections to represent the fact that bend losses typically occur over a range of pipe and not at one point.

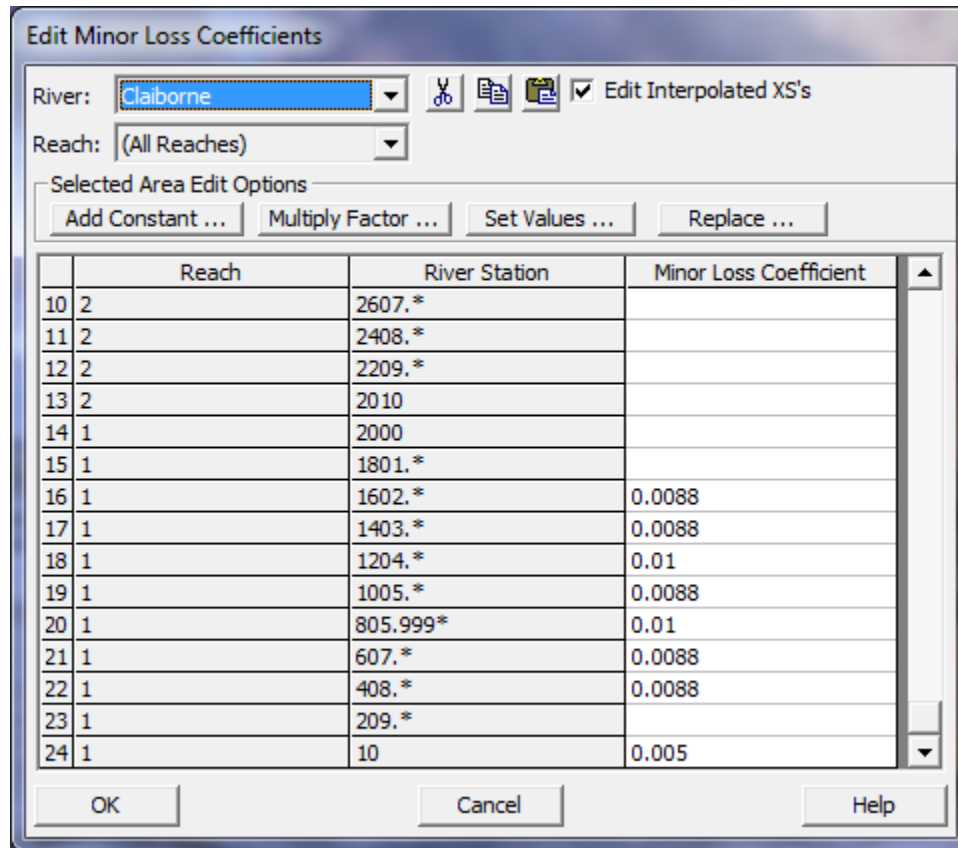

Figure 23-4. Minor Loss Coefficient Editor

### Stream Junction Data

A junction was established by connecting reaches on the river schematic when drawing them. The junction data was added by clicking on the **Junct** icon from the left side of the **Geometric Data Editor**. This activated the **Junction Data Editor** as shown in Figure 23.5. This model consist of 11 junctions, each having a junction length of 10 feet and using the *Energy* method for steady flow computations and *Force Equal WS Elevations* for unsteady flow computations.

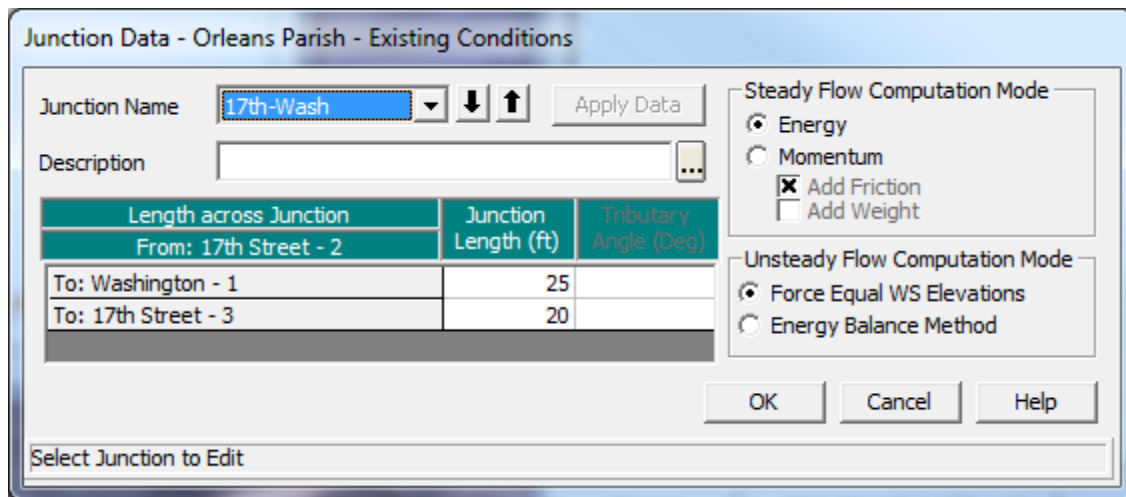

Figure 23-5. Junction Data Editor

## Surface Modeling

The surface flow portion of this urban area is modeled with interconnected storage areas to represent the sheet flow flooding; as well as open channels to represent the surface canal system in this area.

### Creating Storage Areas

When creating the storage areas, first the **Storage Area** icon was selected from the **Tools** toolbar (not to be confused with the Storage Area icon from the **Editors** toolbar) of the **Geometric Data Editor**. The pointer was then placed at the desired location on the river schematic and the storage area was drawn by single clicking and dragging the mouse for each desired point for the storage area. The final point for the storage area was selected by double clicking the mouse. Upon double clicking the mouse, a dialog box appears requesting a storage area name. A name was entered for each storage area created. Points on a storage area may be added or removed by using the **Add Points** to a Reach or SA and **Remove Points** to a Reach or SA options found in the **Edit** menu.

### Entering Data for a Storage Area

After the storage area was drawn in the **Geometric Data Editor** the elevation volume relationship for the storage was established. The data was entered in the **Storage Area Editor**, displayed in Figure 23.6, which is opened by selecting the **Storage Area** icon on the **Editors** toolbar. All the storage areas in this example used the **Elevation versus Volume Curve** to determine a relationship for calculating storage area. This method was

selected by clicking the corresponding radio button and then filling in the elevation volume table listed below it (see Figure 23.6).

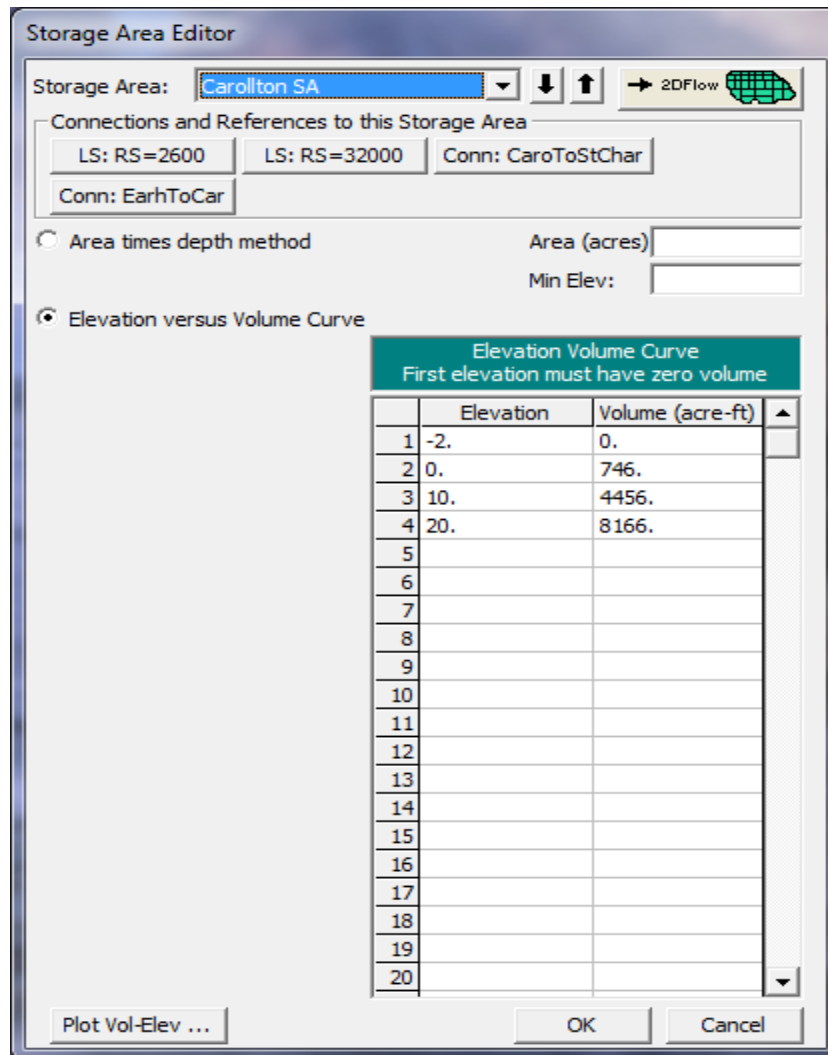

Figure 23-6. Storage Area Editor

### Storage Area Connections

Storage area connections are used to connect storage areas to other storage areas. In this example elevated roadways that divide storage areas are modeled as storage area connections. This feature is used by first selecting the **SA/2D Area Connection** icon from the **Tools** toolbar in the **Geometric Data Editor**. A line can be drawn from one storage area to another by right clicking on the first storage area and then double clicking on the second. A prompt comes up that will ask for the name of the connection. After the user enters a name for the SA connection, it can be selected and edited from the

**SA/2D Area Connection Editor**, which is located on the **Geometric Data Editor** (Figure 23.1).

The storage areas that the connector transferred water to and from were selected by pressing the **Set SA/2D** buttons next to the **From** and **To** location fields. The **Structure Type** was chosen as *Weir* from the drop down menu for all of the storage area connections. Next the **Weir/Embankment** icon was selected. The weir width, coefficient, and weir shape were all entered. In addition the weir station and elevations were entered into the table. Both the *Connection Data Editor* and the *Storage Area Connection Weir Data* can be seen in Figure 23.7.

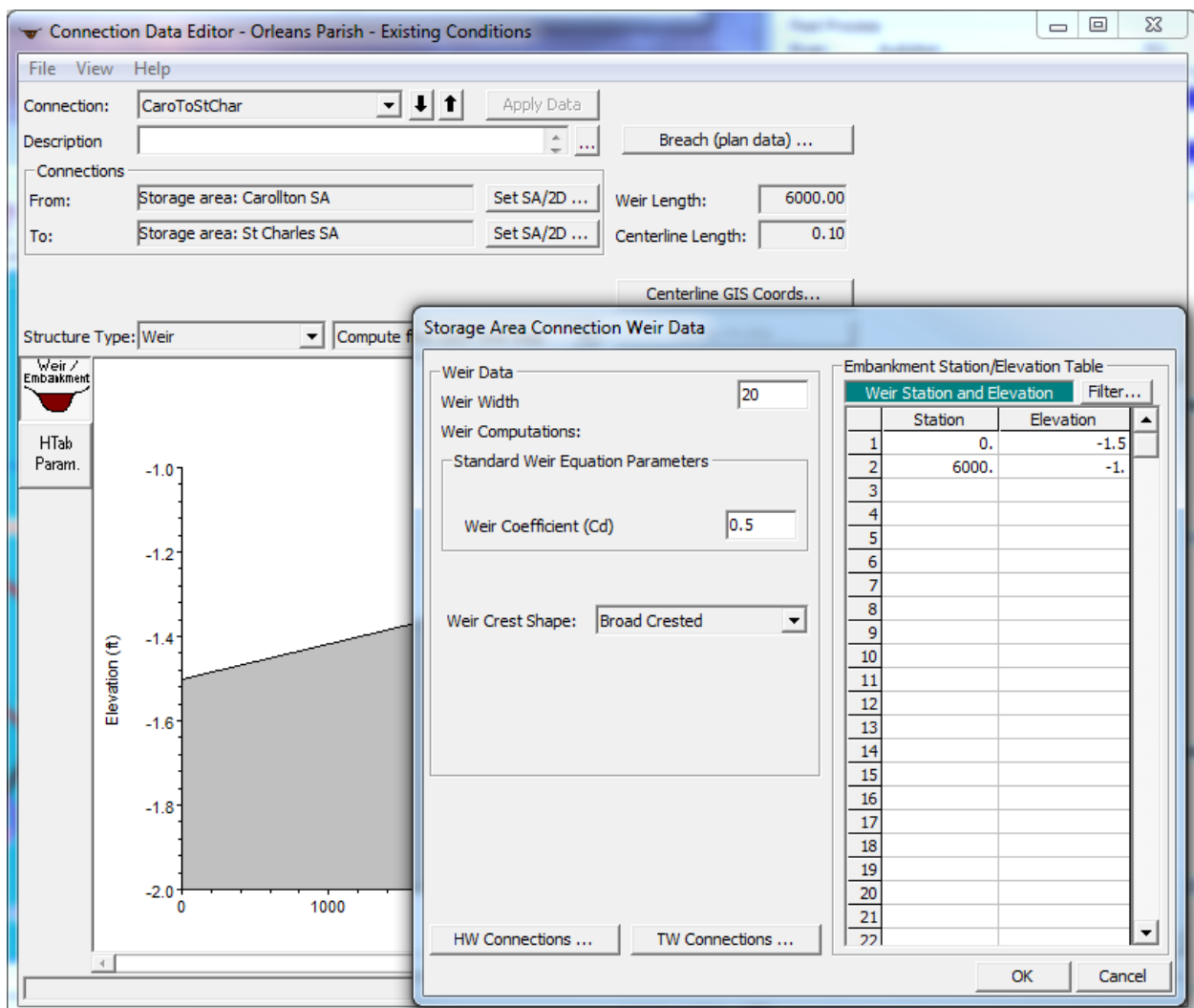

Figure 23-7. Storage Area Connection Data Editor and Storage Area Connection Weir Data Editor



## Lateral Structure Connected to a Storage Area

In this example lateral structures were used to model levees or drop inlets. Since HEC-RAS currently does not have a drop inlet feature for modeling a connection between surface flow and sub surface pipe flow, a lateral structure can be used to connect the subsurface pipe system to the surface storage area system. The storage area can be used to represent surface runoff.

In this model, an example of a lateral structure used as a drop inlet is at river station 3600, which connected Reach 2 of Claiborne River to St. Charles SA. This was accomplished by selecting the **Lateral Structure** icon from the **Editors** toolbar in the **Geometric Data Editor**. After selecting the icon, the **Lateral Structure Data Editor** appears, as shown in Figure 23.8. Once the proper reach and river were selected, under the **Options** menu, **Add a Lateral Structure** was selected. The location of the structure was entered at RS 3600. This placed the beginning of the structure between river stations 3602 and 3403.

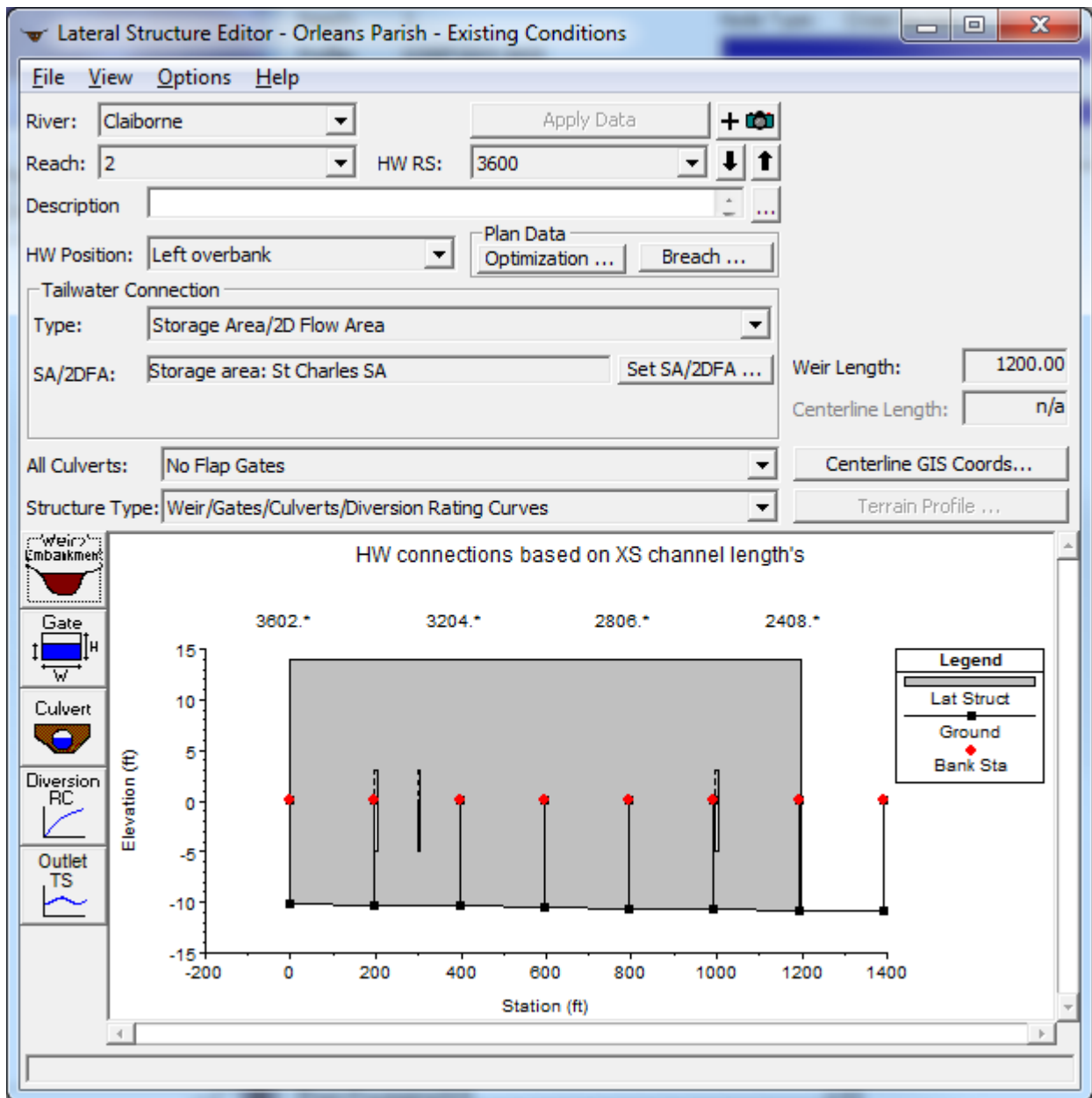

Figure 23-8. Lateral Weir Data Editor

To enter data for the structure, the **Weir/Embankment** icon was selected from the **Lateral Structure Data Editor**. The data were entered as shown in Figure 23.9 on the **Lateral Weir Embankment Window**. The 1200 foot weir is broad crested with a width of 10 feet, placed two feet from the upstream river station 3602 and it has tailwater flow going to a point between two cross sections. The weir flow reference method was chosen as "water surface" and a weir coefficient was established as two.

Returning to the **Lateral Structure Data Editor**, the *HW Position* was selected as "Left overbank" from the pull-down menu and the *Tailwater Connection Type* was chosen as *Storage Area*. Lastly, a connection was made to the storage area by selecting the **Set SA/2DFA** button. A window then popped up, allowing the user to select a storage area to connect to. On the pull-down menu "Storage area: St Charles SA" was selected.

**Lateral Weir Embankment**

Weir Data

Weir Width: 10

Weir Computations: Standard Weir Eqn

Standard Weir Equation Parameters

Weir flow reference: Water Surface

Weir Coefficient (Cd): 2

Weir Crest Shape: Broad Crested

Weir Stationing Reference

HW Distance to Upstream XS: 2

Embankment Station/Elevation Table

	Station	Elevation
1	0.	14.
2	1200.	14.
3		
4		
5		
6		
7		
8		
9		
10		
11		
12		
13		
14		
15		
16		
17		
18		
19		
20		
21		
22		

HW Connections ... TW Connections ... OK Cancel

Figure 23-9. Lateral Weir Embankment Editor

The lateral structure at RS 3600 of Claiborne's Reach 2 has culverts along the structure (as do most of the other lateral structures in the system). To enter the data for the culverts, the **Culvert** icon was selected from the **Lateral Structure Data Editor** (Figure 23.8). This activated the **Culvert Editor** and the data was entered as shown in Figure 23.10. Three five by five box culverts were entered at centerline stations 200, 300, and 1000. The culverts were identical, each having a length of 200 feet and flared wingwalls. No flap gates were used at this lateral structure. For more information on entering culverts the user is encouraged to review examples 3 or 4 and Chapter 6 of the User's Manual.

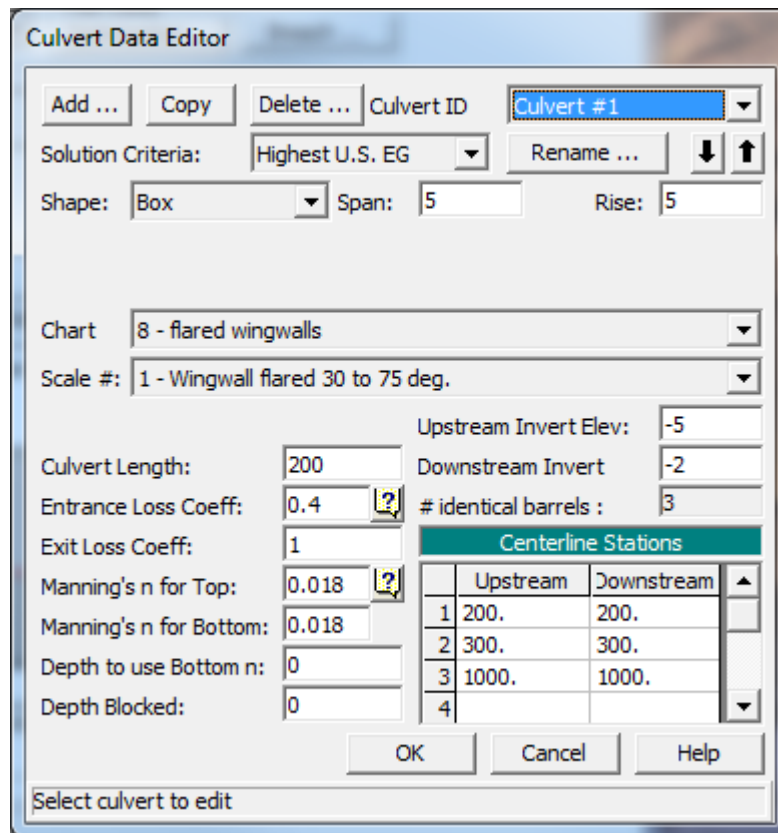

Figure 23-10. Culvert Data Editor

### Levee (Lateral Structure) Breach Data

Several of the lateral structures in this model were used to represent levees. Once the levee is overtopped, the flow going over the top of the levee is calculated using the weir equations. Modeling the levees as lateral weirs also has the advantage of allowing the user to model a levee breach. The 17<sup>th</sup> Street levee (lateral structure) on Reach 2 at RS 16500 was the only structure to be breached in this model.

The breach data is entered from the **Lateral Structure Editor** (as shown in Figure 23.8) by clicking the **Breach** button under the heading *Plan Data*. Once clicked, a window will appear titled "Levee (Lateral Structure) Breach Data" as seen in Figure 23.11. First, the option *Breach This Structure* was checked on. Next, the remaining fields were entered as shown in Figure 23.11. The levee breach was modeled with a piping failure mode, which was triggered at a water surface elevation of 11.2 feet. A description of each of the fields for the editor is described in Chapter 8 of the User's Manual. Once all the breach data is entered, the breach area is displayed on the lateral structure in the Breach Plot.

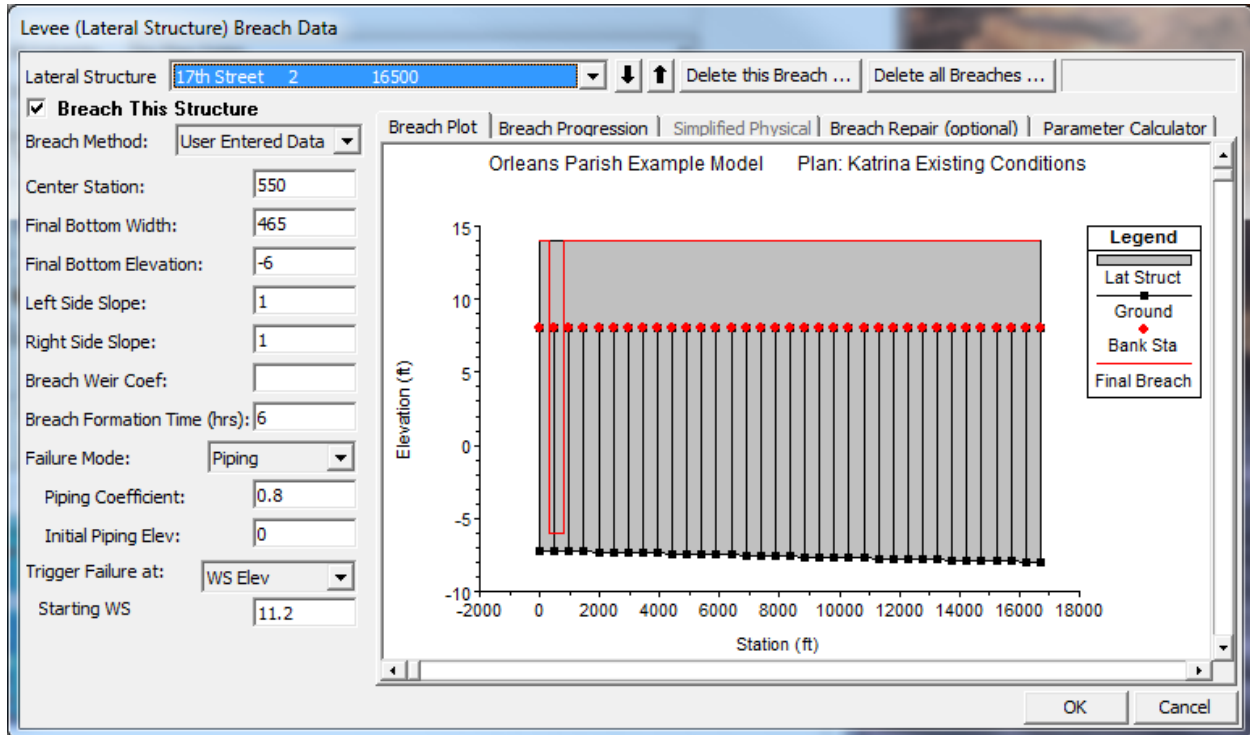

Figure 23-11. Levee (Lateral Structure) Breach Data Editor

The *Breach Progression* tab was chosen next and a one-to-one linear relationship was established between the breach time and the breach completion by clicking **Set to Linear**. Alternatively, *Sine Wave* could have been selected, giving the breach completion/time relationship a sine correlation.

Lastly, the optional *Breach Repair* tab was selected from the Levee (Lateral Structure) Breach Data Editor. This option allows the user to signify that the levee will be repaired during the course of the simulation, thereby altering the lateral structure's geometry and unsteady flow calculations. The three fields that must be filled in by the user if selected are: *Number of hours after full breach to start repair*, *Total repair time (hours)*, and *Final filled in elevation*. For this example, the fields' values were 48 hours, 24 hours, and 10 feet, respectively.

## Inline Structure

An inline structure was used in this data set to represent the 17<sup>th</sup> street canal pump station. To add an inline structure, the **Inline Structure** icon was selected from the left side of the **Geometric Data Editor**. This activated the **Inline Structure Data Editor** as shown in Figure 23.12. River "17<sup>th</sup> Street" and Reach "2" were chosen, then, **Options** and **Add an Inline Structure**

were selected and river station 21150 was entered as the location for the weir. The schematic then displayed the cross section data for the river station immediately upstream of the weir location - river station 21200 for this example.

After entering a brief description, a pilot flow of 1 cfs was entered directly beneath the *Description* field. The *Pilot Flow* field sets a minimum flow release from the structure, thereby allowing the user to ensure that the weir is always passing flow downstream, even in low flows. In HEC-RAS, no cross section in the model can go dry during the simulation. While there can be zero flow at the structure, the upstream and downstream cross sections must always have water in them. The pilot flow is a simple way to ensure that there is always some minor flow going through the structure.

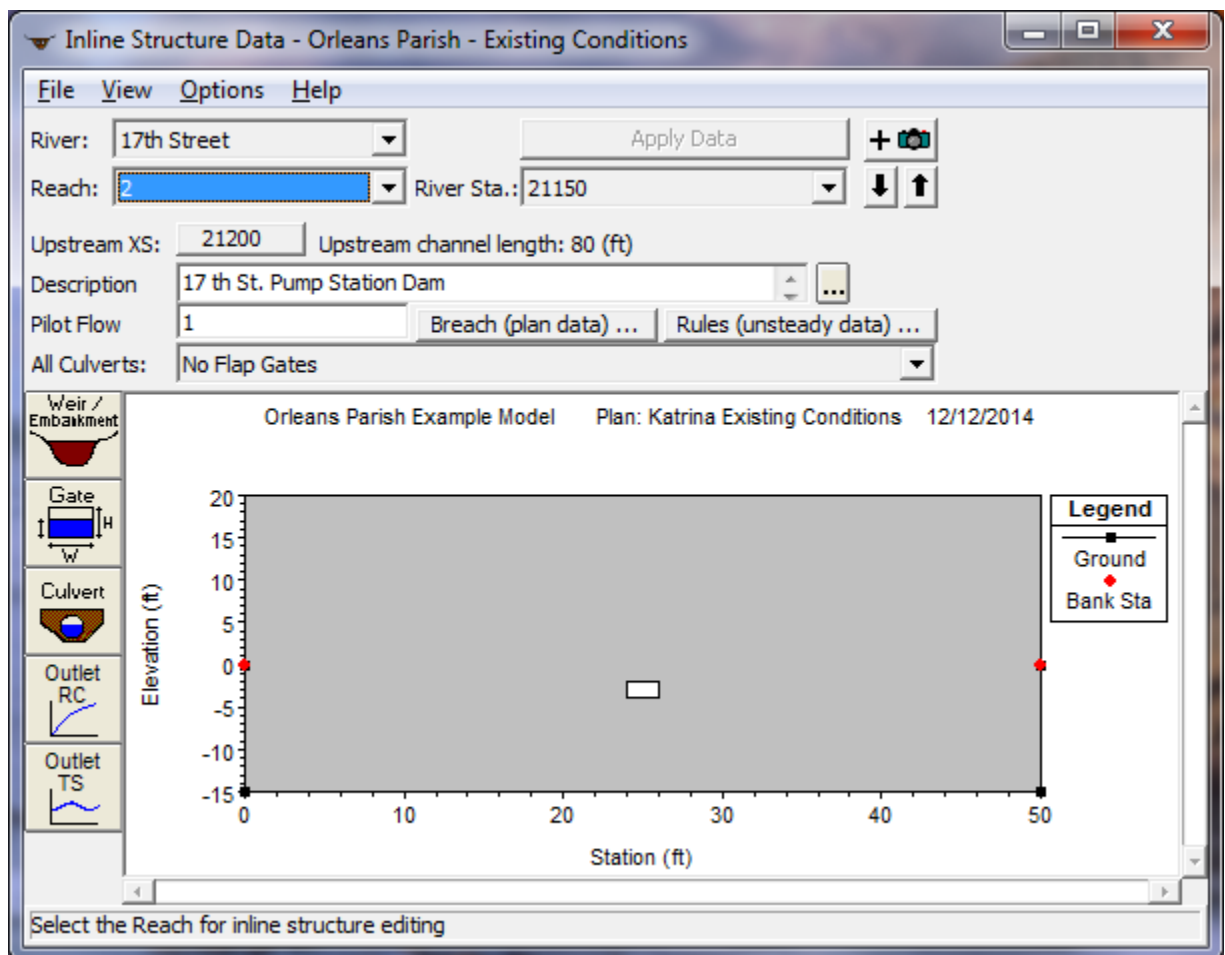

Figure 23-12. Inline Structure Data Editor

Next the weir data was entered. To enter the data for the weir, the **Weir/Embankment** icon was selected from the left side of the **Inline Structure Data Editor**. This activated the **Inline Structure Weir Station**

**Elevation Data Editor** as shown in Figure 23.13. This editor is similar to the deck/roadway editor used for bridges and culverts.

Distance	Width	Weir Coef
20	40	2.6

Edit Station and Elevation coordinates	
Station	Elevation
1 0.	20.
2 50.	20.
3	
4	
5	
6	
7	
8	

U.S Embankment SS: 0      D.S Embankment SS: 0

Weir Data  
Weir Crest Shape  
 Broad Crested  
 Ogee

OK      Cancel

Enter distance between upstream cross section and deck/roadway. (ft)

Figure 23-13. Inline Structure Station Elevation Data Editor

The top row of the editor consists of three data entry fields. For the first field, the user must enter the *Distance* from the upstream cross section (RS 21200) to the upstream side of the weir. For this example, this distance was 20 feet. Next, the *Width* of the weir was entered as 40 feet. This is a total distance of 60 feet. The distance from river station 21200 to 21120 is 80 feet. Therefore, the distance from the downstream end of the weir to cross-section 21120 is 20 feet. The last field in the top row of the editor is the *Weir Coefficient* and was entered as 2.6, coinciding with the *Broad Crested* weir shape chosen at the bottom of the editor.

The central portion of the editor consists of a table in which the user must enter the station and elevation data for the weir. The first station of the weir was entered as zero and the last station is at 50 feet – both have an elevation of 20 feet. With these weir stations and elevation, the program will block out the entire area below the weir crest.

The inline structure has one gate. To enter the data for the gates, the **Gate** icon was selected from the **Inline Structure Data Editor** (Figure 23.12). This activated the **Gate Editor** as shown in Figure 23.14. The *Gate type* (or

methodology) was left at the default of "Sluice" from the pull down menu. The *Orifice Coefficient*, *Weir Shape*, *Head Reference*, and *Weir Coefficient* were also kept at their default values (0.8, Sill (Invert), Broad Crested, and 3, respectively). The *Sluice Discharge Coefficient* was set to 0.6. The gate was set with a centerline station of 25 and an invert of -4 feet. It was 2 feet in height and width. The **OK** button was selected at the bottom of the **Gate Editor** and the gates appeared on the **Inline Structure Data Editor** as shown in Figure 23.12. The **Inline Structure Data Editor** was then closed.

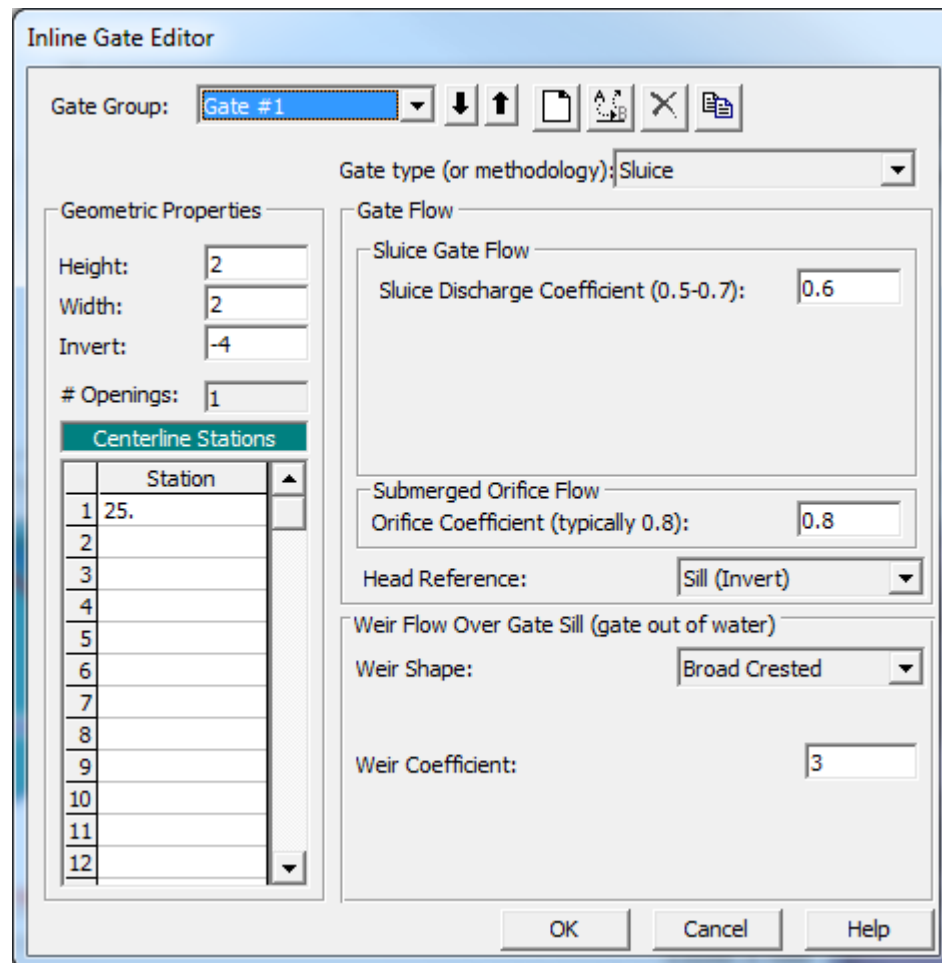

Figure 23-14. Inline Gate Editor

## Pump Station

A pump station is used in this example to move water from the 17<sup>th</sup> St. Pump Station sump to the outflow canal on the same reach. A pump was added by selecting the **Pump Station** drawing tool at the top of the **Geometric Data**



**Editor.** Once the button was pressed, the mouse icon changed to a set of cross hairs with a pump. The pump was placed to the left of the dam and given the name “17thPumpSta” when prompted for a name.

Next, the **Pump Station** editing tool was selected from the left of the **Geometric Data Editor**. The Pump Station editor appeared as in Figure 23.15. There are three tabs on the pump station editor, the first is for the pump connection data, the second is for the pump group data, and the third is for the applying advanced rule controls over the pump station. A detailed description of each field within these tabs can be found in Chapter 6 of the User’s Manual.

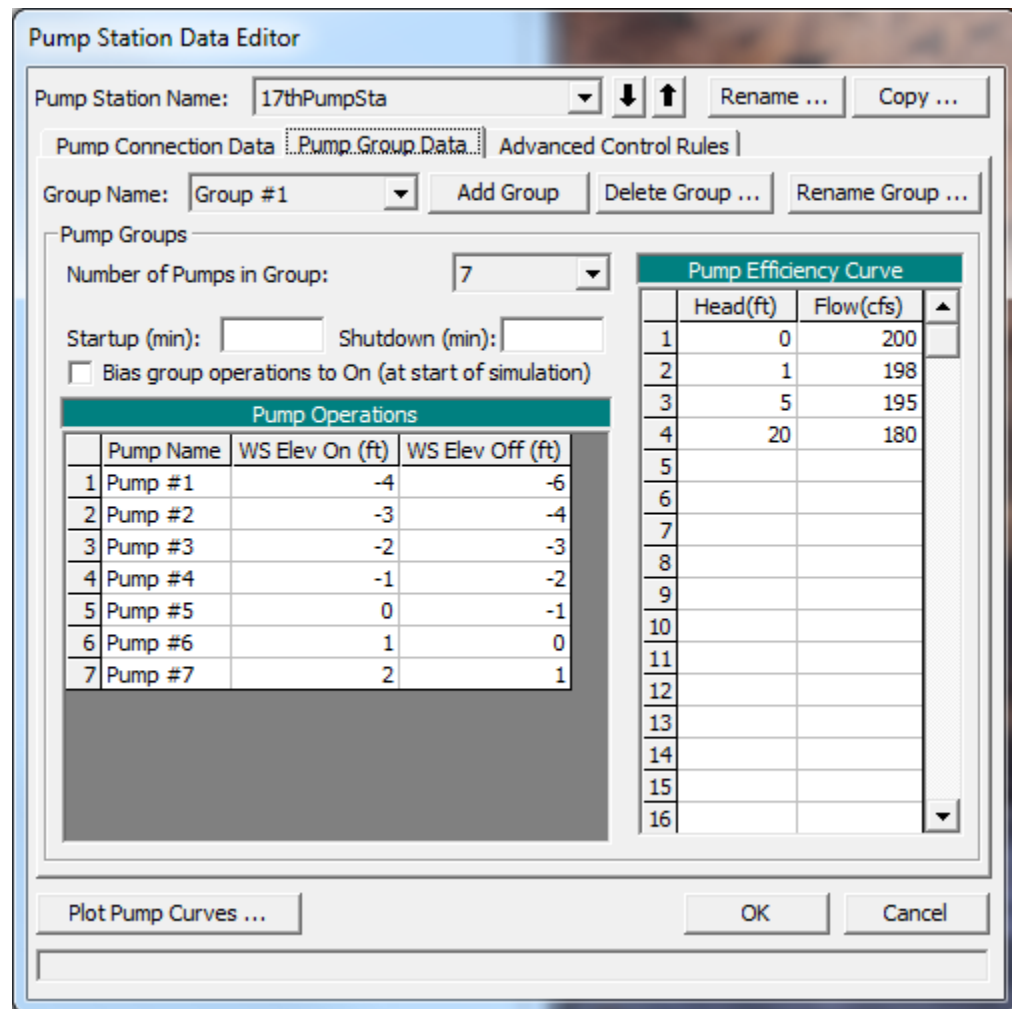

Figure 23-15. Pump Station Data Editor (Pump Group Data Tab)

The *Pump Connection Data* was entered first. This was done by clicking the button **Set RS** adjacent to the *Pump From* field. Once selected, “17<sup>th</sup> Street”, “2”, and “21392” were selected from the *River*, *Reach*, and *River Station* dropdown menus, respectively. **OK** was clicked and the *Pump To* field was

set in a similar manner so that the pump released its water downstream to RS 20628.8.

The *Pump Group Data* was then entered by selecting the second tab. There is only one pump group in this data set; therefore, no additional groups needed to be added. Adding, deleting, and renaming pump groups can be done at the top of the editor using the buttons labeled as such (See Figure 23.15). The *Number of Pumps in Group* was selected as 7 from the drop down menu. The pump *Startup* and *Shutdown* times were both set to 15 minutes. Each pump was then given a water surface elevation in which the each pump was designated to turn on or off. The *Pump Efficiency Curve* head and flow values were then entered as seen in Figure 23.15. The head represents the total head in the system, which is typically the difference in the water surface elevations between the “from” and the “to” location; however, in HEC-RAS the relationship between head difference and flow should already account for all energy losses in the pump line (friction, bends, junctions, etc...). The rated pump curve from the manufacturer could not be entered because it didn't account for losses. The pump curve used in HEC-RAS was derived by subtracting all energy losses from the manufacturer's pump efficiency curve. The pump efficiency curve was then plotted for visual inspection by pressing the **Plot Pump Curves** button at the bottom of the window.

Lastly, the *Advanced Control Rules* tab was selected (Figure 23.16). This optional tab allows the user to specify rules that will override the physical pump data. Pressing the **Add New Rule** button opened a window that had six different rule types to choose from: *Always apply this rule*; *Apply based on target flow*; *Apply based on target WS*; *Apply based on day/hour*; *Apply based on day/hour and flow*; and *Apply based on day/hour and WS*. More details on each type can be found in Chapter 6 of the User's Manual. For this example, a new rule was created using the *Apply based on day/hour* type that restricted the maximum flow rate leaving the pump station to 100 cfs starting at noon on August 29 until zero hundred hours September 30. The transition time was set to 10 minutes. The transition time can allow for a smoother and more stable change in pumping rates.

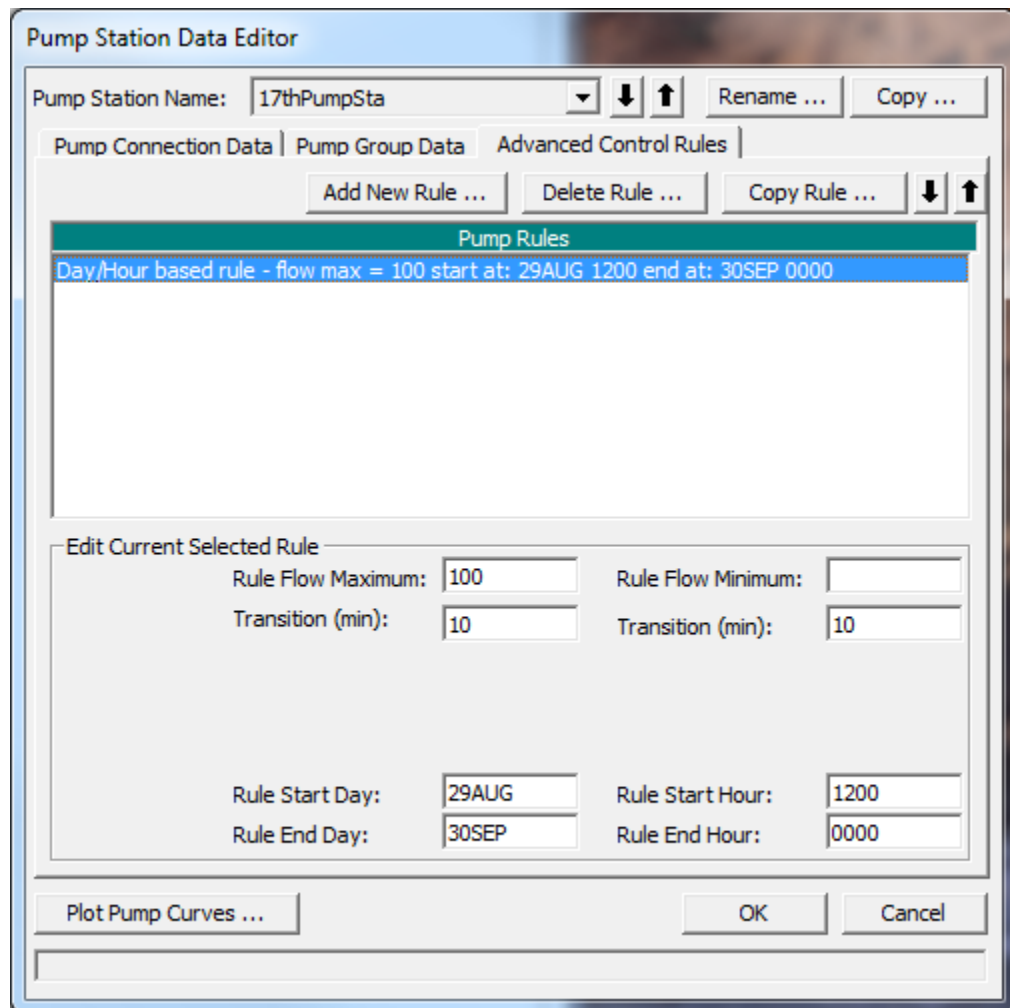

Figure 23-16. Pump Station Data Editor (Advanced Control Rules Tab)

## Cross Section Hydraulic Table Parameters

In HEC-RAS, cross sections are processed into tables of elevation versus hydraulic properties of areas, conveyances, and storage. The user is required to set an interval for spacing the points in the cross-section tables. In the **Geometric Data Editor** the icon **Htab Parameters** was selected under the **Editors** toolbar. This displays the **Cross Section Table Parameters Window** shown in Figure 23.17. The starting elevation, table increment, and number of points columns are automatically filled by the program but may be changed by the user. The program automatically starts the table for each cross section 1 foot above the channel invert. The program chooses a table increment and number of points by first attempting to use 20 points, and choosing an increment that will put the table up to the top of the cross section. If this results in too large of an increment (greater than 1.0 foot) the

program will use a one foot increment and add additional points to get the table to the top of the cross section. The increment for this example was set to 1 for "All Reaches" by highlighting the increment column and selecting the **Set Values** button. The user can set individual values for each cross section if it is deemed necessary. **Warning: Always ensure that your cross section tables encompass the complete range of stages that will be modeled.** If the tables do not go up to a high enough elevation, the program will have to extrapolate during the computations. More often than not, the extrapolation causes instabilities in the results. To visualize the extent of the tables, a graphic of individual cross sections is shown on the right hand side of the window. The graphic displays the cross section corresponding to the row in which you cursor lies in the table.

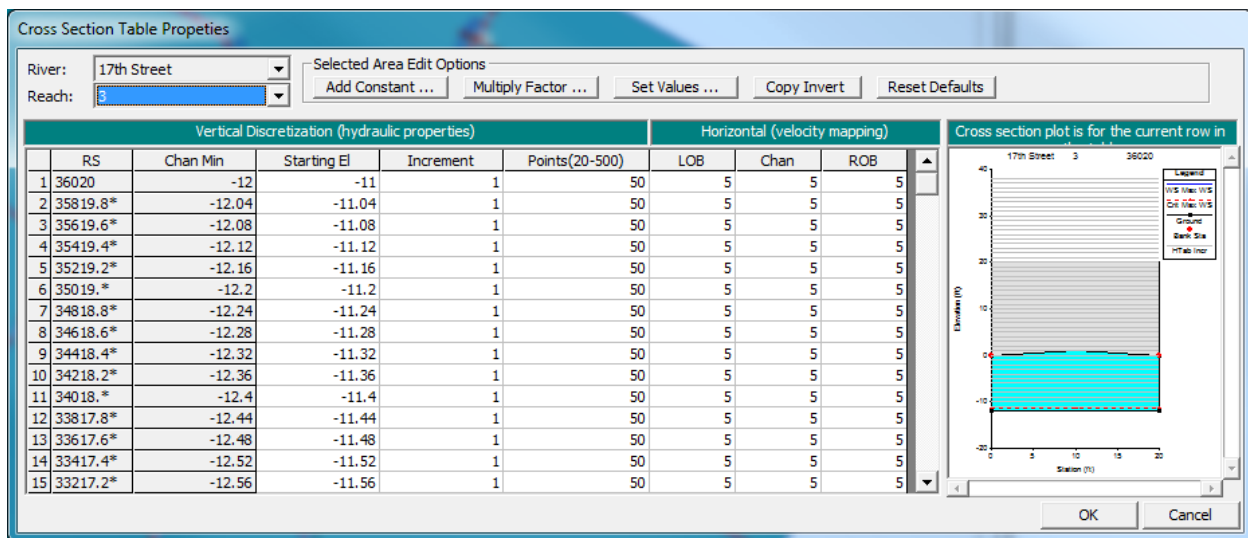

Figure 23-17. Cross Section Table Parameters

## Unsteady Flow Data

The user is required to enter boundary conditions to describe the event, and initial conditions for the system at the beginning of the simulation period. For additional information on unsteady flow data refer to Chapter 8 of the User's Manual, Performing an Unsteady Flow Analysis. The **Unsteady Flow Data Editor**, shown in Figure 23.18, was selected from the main program window under the **Edit** menu.

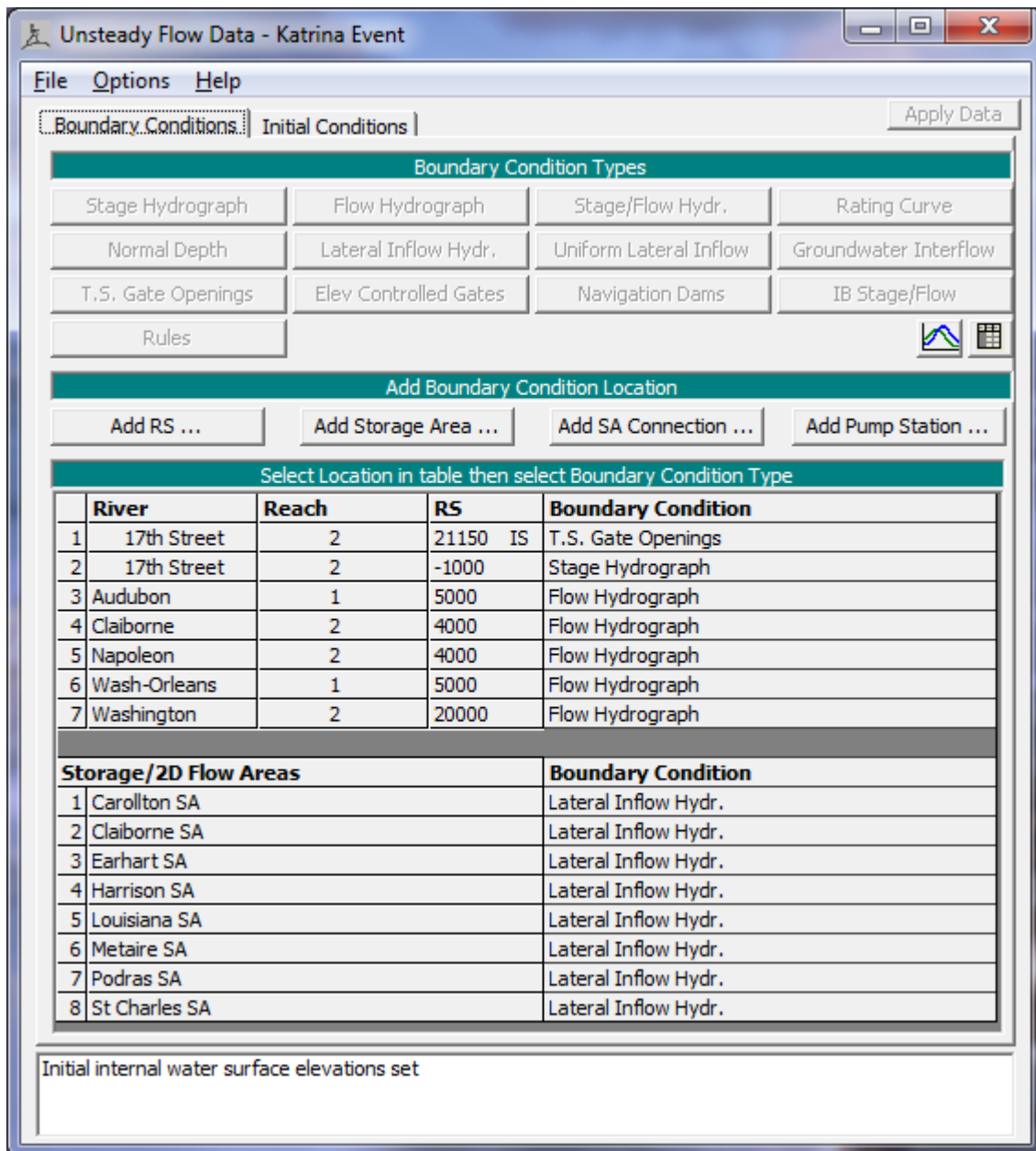

Figure 23-18. Unsteady Flow Data Editor

### Boundary Conditions

Boundary conditions are required for the farthest upstream and downstream cross sections of the river system. Upon entering the **Unsteady Flow Data Editor** the farthest upstream and downstream cross sections will automatically be located in the boundary conditions column. In addition, features such as gated inline structures, which also require a boundary

condition, will automatically be populated in the *Boundary Condition* table. In this example there are 15 total boundary conditions: five upstream BC, one downstream BC, and nine internal BC (eight of which are for storage areas).

Boundary conditions are set by highlighting the adjacent cell under **Boundary Condition Type**. When a cell is highlighted, not all boundary conditions are available. The program will automatically gray out all irrelevant boundary condition types. Internal boundary conditions may be added by selecting one of the buttons under the "Add Boundary Condition Location" heading.

### Upstream Boundary Conditions

Flow hydrographs were selected for the six upstream boundary conditions by highlighting the *Boundary Condition* cell and pressing the **Flow Hydrograph** button. The window where the **Flow Hydrograph** is entered is shown in Figure 23.19. The user may select to read hydrograph data from a DSS file or manual enter the data. For further instruction on using a DSS file see *Unsteady Flow Application Example 17*. For this example the flow hydrograph was manually entered by selecting the **Enter Table** radio button. The **Data Time Interval** was set to one hour and the radio button **Use Simulation Time** was selected causing the initial propagation of the hydrograph to coincide with the beginning of the simulation time window. The hydrograph was then manually entered into the table.

**Flow Hydrograph**

River: Washington Reach: 2 RS: 20000

Read from DSS before simulation Select DSS file and Path

File:

Path:

Enter Table Data time interval: 1 Hour

Select/Enter the Data's Starting Time Reference

Use Simulation Time: Date: 28AUG2005 Time: 0000

Fixed Start Time: Date:  Time:

No. Ordinates

Hydrograph Data			
	Date	Simulation Time (hours)	Flow (cfs)
1	27Aug2005 2400	00:00	50.
2	28Aug2005 0100	01:00	50.
3	28Aug2005 0200	02:00	50.
4	28Aug2005 0300	03:00	50.
5	28Aug2005 0400	04:00	50.
6	28Aug2005 0500	05:00	50.

Time Step Adjustment Options ("Critical" boundary conditions)

Monitor this hydrograph for adjustments to computational time step

Max Change in Flow (without changing time step):

Min Flow:  Multiplier:

Figure 23-19. Flow Hydrograph for Upstream Boundary Condition

### Downstream Boundary Condition

The boundary condition selected for River Station -1000 of 17<sup>th</sup> Street, Reach 2 was a stage hydrograph. This stage hydrograph was used to represent the storm surge that occurred inside of Lake Ponchartrain during Hurricane Katrina. Again, the corresponding cell for that particular river station was highlighted and then the **Stage Hydrograph** button was selected. A window appears that looks nearly identical to the flow hydrograph editor; however, stage values are entered instead of flows. The data time interval was set to one hour and the starting time reference was selected as the simulation time. The stage values were manually entered in the *Hydrograph Data*

### **Internal Boundary Conditions**

Boundary conditions were entered for the gate of the inline structure and the storage areas. The inline structure (RS 21150 of 17<sup>th</sup> Street, Reach 2) utilized "*T.S. Gate Openings*" while the storage areas used a "*Lateral Inflow Hydrograph*." These boundary condition types were selected in the same manner as the upstream and downstream boundary condition types were selected.

All of the internal boundary conditions used a one hour data time interval and its start time coincided with the simulation time. The gate opening height and the lateral inflow were then manually entered into their respective tables. An example of each boundary condition type can be seen in Figure 23.20.



**Lateral Inflow Hydrograph** SA: Carollton SA

Read from DSS before simulation Select DSS file and Path

File:   
Path:

Enter Table Data time interval: 1 Hour

Select/Enter the Data's Starting Time Reference

Use Simulation Time: Date: 28AUG2005 Time: 0000  
 Fixed Start Time: Date:  Time:

No. Ordinates

Hydrograph Data			
	Date	Simulation Time (hours)	Lateral Inflow (cfs)
1	27Aug2005 2400	00:00	50.
2	28Aug2005 0100	01:00	52.08
3	28Aug2005 0200	02:00	54.17
4	28Aug2005 0300	03:00	56.25
5	28Aug2005 0400	04:00	58.33
6	28Aug2005 0500	05:00	60.42

Monitor this hydrograph for adjustments to computational time step  
 Max Change in Flow (without changing time step):

Min Flow:  Multiplier:

**Gate Openings** River: 17th Street Reach: 2 RS: 21150

Gate Group: Gate #1

Read from DSS before simulation Select DSS file and Path

File:   
Path:

Enter Table Data time interval: 1 Hour

Select/Enter the Data's Starting Time Reference

Use Simulation Time: Date: 28AUG2005 Time: 0000  
 Fixed Start Time: Date:  Time:

No. Ordinates

Hydrograph Data			
	Date	Simulation Time (hours)	Gate Opening Height (ft)
1	27Aug2005 2400	00:00	0.1
2	28Aug2005 0100	01:00	0.1
3	28Aug2005 0200	02:00	0.1
4	28Aug2005 0300	03:00	0.1
5	28Aug2005 0400	04:00	0.1
6	28Aug2005 0500	05:00	0.1
7	28Aug2005 0600	06:00	0.1
8	28Aug2005 0700	07:00	0.1
9	28Aug2005 0800	08:00	0.1

Figure 23-20. Lateral Inflow Hydrograph Editor for SA and T.S. Gate Opening Editor for IS

### **Initial Conditions**

Initial conditions consist of flow information at each of the cross sections, as well as elevations for any storage areas defined in the system. Data for initial conditions is established by selecting the **Initial Conditions** tab on the **Unsteady Flow Data Editor**. After selecting the tab, Figure 23.21 will be displayed.

Boundary Conditions: Initial Conditions

Initial Flow Distribution Method

Use a Restart File      Filename:

Enter Initial flow distribution (Optional - leave blank to use boundary conditions)

Add RS...

User specified fixed flows (Optional)				
	River	Reach	RS	Initial Flow
1	17th Street	3	36020	75
2	17th Street	2	26000	250
3	Audubon	1	5000	50
4	Claiborne	2	4000	50
5	Claiborne	1	2000	25
6	ClaTo17th	1	2000	25
7	Napoleon	2	4000	50
8	Napoleon	1	1000	75
9	Wash-Orleans	1	5000	50
10	Washington	2	20000	50

Initial Elevation of Storage Areas/2D Flow Areas (Optional)      Import Min SA Elevation(s)

Keep initial elevations constant during warmup

	Storage Area/2D Flow Area	Initial Elevation
1	Carollton SA	-2
2	Claiborne SA	-2
3	Earhart SA	-4
4	Harrison SA	-6
5	Louisiana SA	-2
6	Metairie SA	-4
7	Podras SA	-2
8	St Charles SA	-2

Initial internal water surface elevations set

Figure 23-21. Unsteady Flow Data Initial Conditions

As seen in Figure 23.21, the **Enter Initial flow distribution** radio button was selected and initial flows were entered at the upstream river station of each of the 11 reaches. The initial elevation of all eight storage areas was set to the minimum storage area elevation by clicking **Import Min SA Elevation(s)**. The *Initial Elevation* field is then populated with all the storage area's minimum elevation from the Geometric Editor. The data was then saved (**File -> Save Unsteady Flow Data As**) in the **Unsteady Flow Data Editor** and the window was closed.

## Unsteady Flow Analysis

After the geometry and unsteady flow data have been completed an unsteady flow analysis may be initiated. Under the main program window **Unsteady Flow Analysis** was selected under the **Run** menu. This will display the **Unsteady Flow Analysis Window** shown in Figure 23.22. A plan was defined by selecting the Geometry File "Orleans Parish – Existing Conditions" and the Unsteady Flow File "Katrina Event." Under the **File** menu, **Save Plan As** was selected and the plan title was entered as "Katrina Existing Conditions." After entering the title of the plan a short identifier was entered as "KatrinatExist" and the plan was saved. The data was entered as seen in Figure 23.22 below. For more information on the *Simulation Time Window*, *Computation Settings*, and *Programs to Run* refer to *Unsteady Flow Application – Example 17*.

Note: The data entered for the levee breach in the Geometric Data Editor can also be entered through the Unsteady Flow Analysis window. The user can open the *Levee (Lateral Structure) Breach Data* by clicking on **Options** then **Levee (Lateral Structure) Breach** from the Unsteady Flow Analysis window.

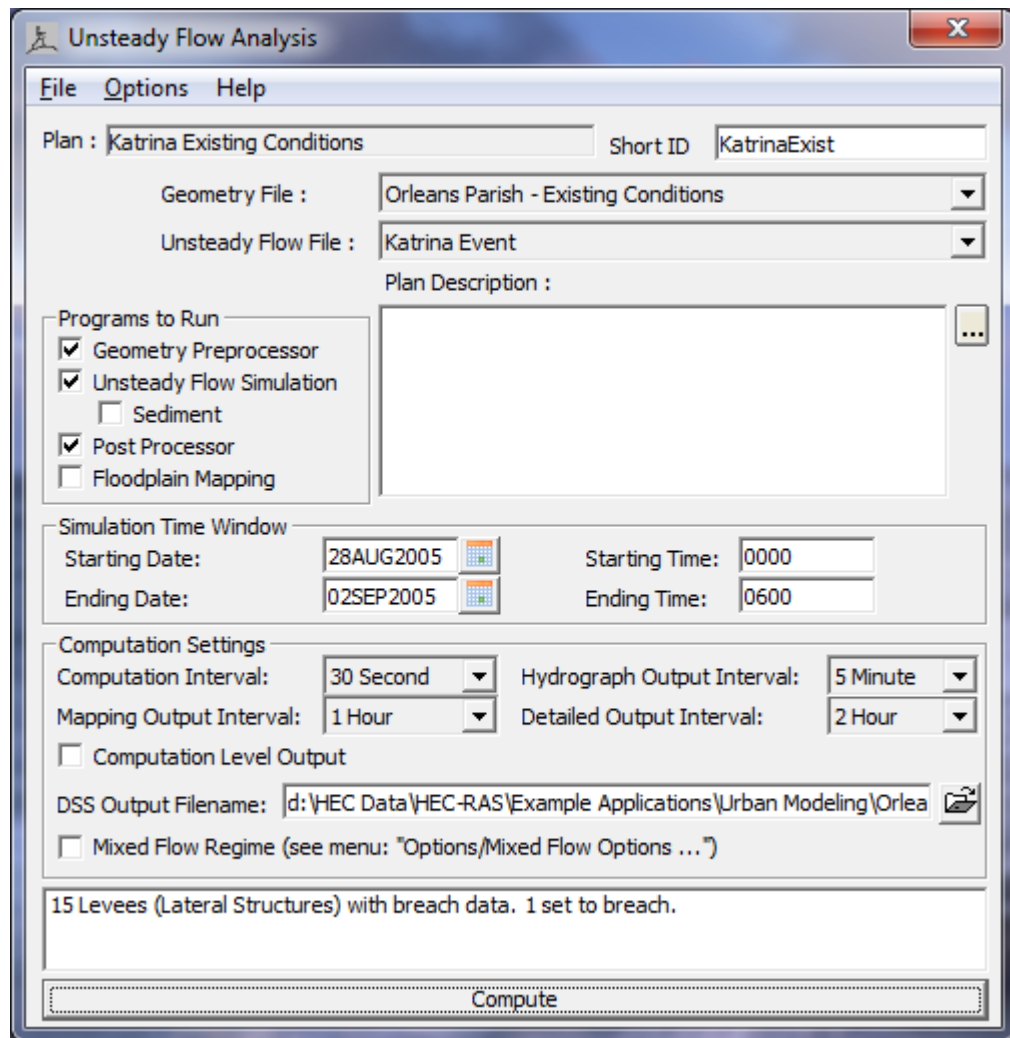

Figure 23-22. Unsteady Flow Analysis

## Output Analysis

For the analysis of the output, a portion of the system's *Water Surface Profiles* were reviewed, as well as the *Stage and Flow Hydrographs* for the pump station. These are discussed in the following sections.

### Water Surface Profiles

The water surface profiles are shown in Figure 23.23. This figure was activated from the main program window by selecting **View** and then **Water Surface Profiles**. The figure shows the maximum water surface profile on Reach 1 and 2 of both 17<sup>th</sup> Street and Claiborne. The lighter gray structures

represent lateral structures, whereas the darker gray area represents a cross section lid. From the figure below it can be seen that the water surface elevation rises above the bottom of the lid and is identical to the energy grade line. The water surface profile is actually a representation of the water surface within a very small opening that extends through the top of the lid. This small opening is necessary for using the Priessmann slot theory, which is the method that allows pressurized pipes to be modeled with unsteady flow in HEC-RAS.

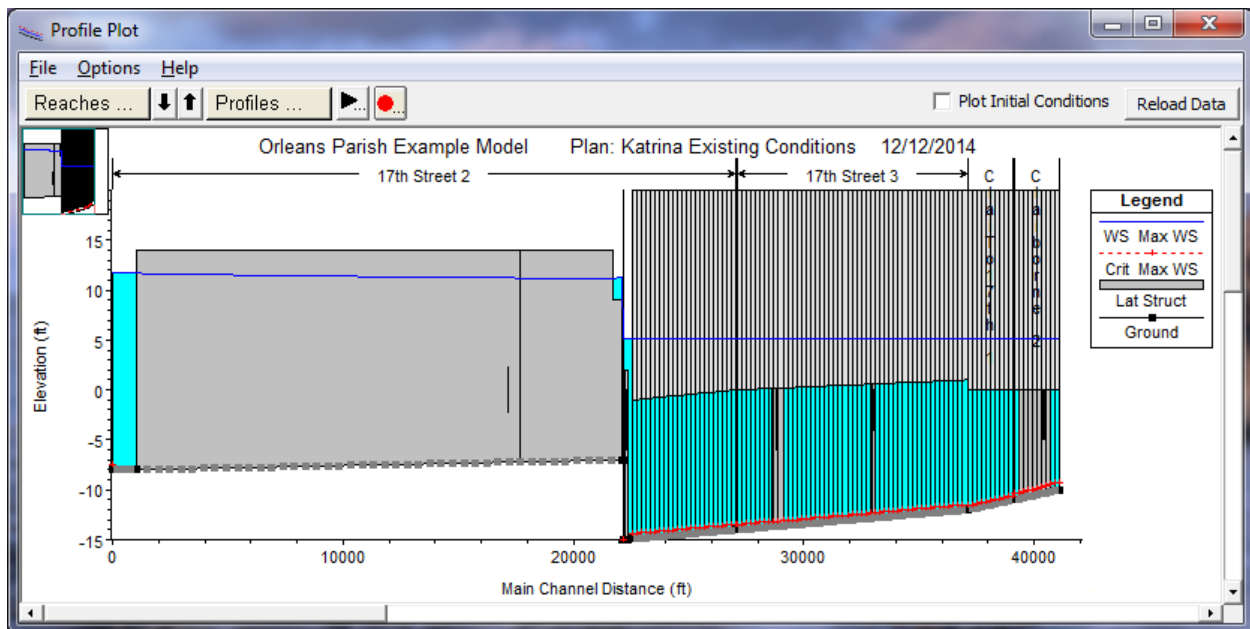

Figure 23-23. Water Surface Profiles for Reach 1 & 2 of 17<sup>th</sup> Street and Claiborne

## Stage and Flow Hydrographs

The output from the simulation can be viewed from many different tables and graphs. The most interesting output for the pump station in this example is found by viewing the stage and flow hydrographs. From the main program window, **View** and then **Stage and Flow Hydrograph** was selected. By selecting the **Type** menu on the **Stage and Flow Hydrograph Window** the user can view stage and flow hydrographs for cross sections, bridges, culverts, inline structures, lateral structures, storage areas, storage area connections, and pump stations.

The **"Pump Stations"** option was selected from the **Type** menu, which then displayed the stage and flow hydrographs seen in Figure 23.24. As seen from the figure, the initial headwater stage was -4 feet. Therefore, only one pump was turned on (see *Pump Station Data Editor*), producing a flow of approximately 200 cfs. At 10 A.M. on August 28 the flow abruptly increased to approximately 400 cfs, followed by a stint with a steady pump rate around 400 cfs, and then a drop in flow back to approximately 200 cfs. This process

was repeated and at 12 P.M. on August 29 the pump rate went to 100 and remained there for the remainder of the simulation. This can be explained by simultaneously reviewing the hydrographs with the pump station data. The increases in pump rate are due to the increase in the headwater stage from -4 feet to -3 feet. According to the pump data, this increase caused another pump to turn on, thereby increasing total flow by nearly 200 cfs. The increased pumping rate subsequently caused the headwater stage to decrease, thereby turning off one of the pumps and reducing the pump rate. This process was repeated until at 12 P.M. on August 29 the *Advanced Control Rules* from the *Pump Station Data Editor* was activated. The rule caused all subsequent flow rates from the pump station to hold steady at 100 cfs.

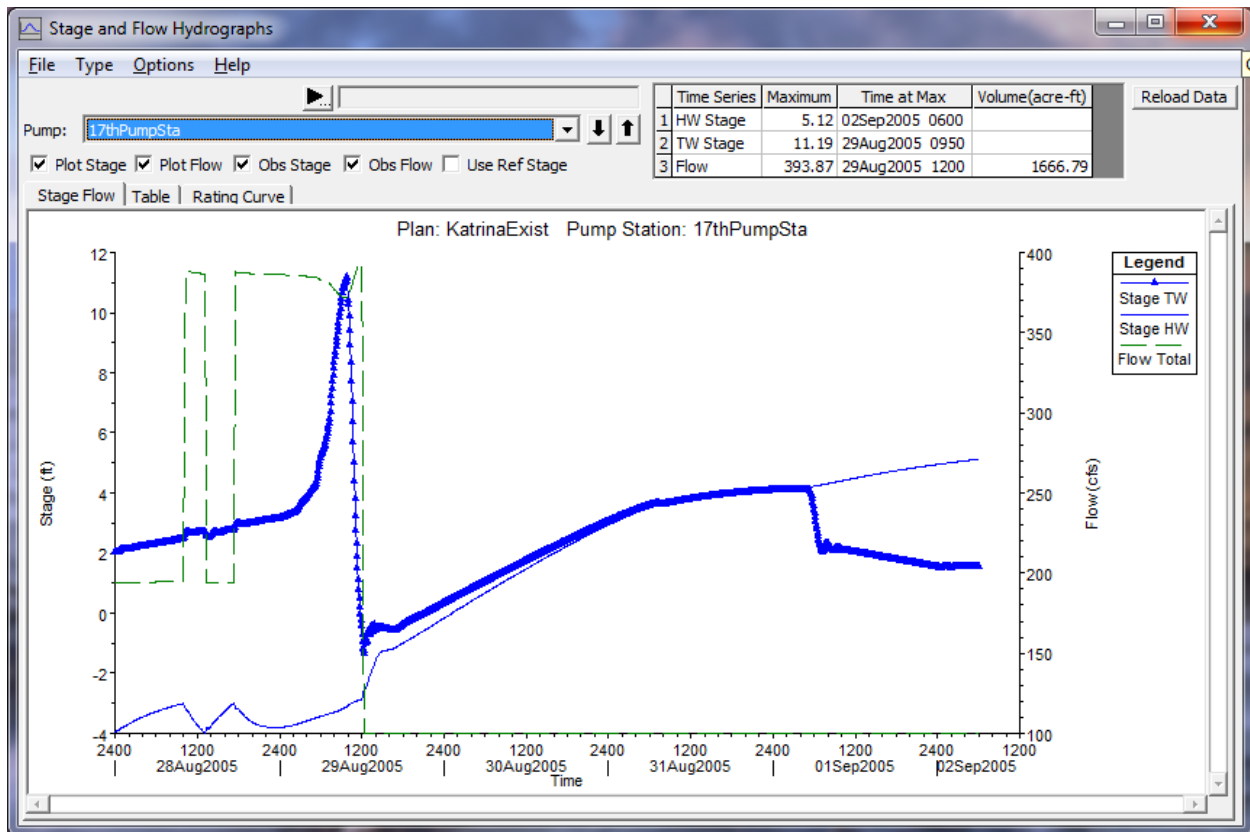

Figure 23-24. Stage and Flow Hydrograph for the 17<sup>th</sup> Street Pump Station

## Summary

Urban modeling is unique in that it often incorporates several HEC-RAS elements that many river systems don't utilize. This example gave note to many of those features - pressurized pipe flow, how to model pipe

connections, drop inlets, minor losses, levee breaches, interconnected storage areas (surface overland flow system) and pump stations – by modeling a portion of a New Orleans Parish system. For many of these features, the user was shown how to access them from the Geometric Data Editor. For instance, the user was shown how to turn a typical cross section into a pipe by using the Lid feature which is accessed through the *Cross Section Editor*. After entering all of the geometric data, the user was shown how to enter the unsteady flow data, as well as the plan information. Once the model was run, some of the relevant output data is reviewed.



## CHAPTER 24

## Manning's n Calibration

### Purpose

When using HEC-RAS, the user's objective is to create a model that is accurate and properly represents a real-world river system. However, there are some features of the river that are not explicit but must be determined by trial and error and sound engineering judgment. If the river has reliable gages, for unsteady flow models, the user can use the historic gage flows to calibrate the model to real-world events. One of the primary inputs that is adjusted during calibration is the Manning's n value since this variable often has the most uncertainty and variability amongst the HEC-RAS input. Since calibrating a model (especially a large one) to one or more gages can be a long and tedious task, HEC-RAS has a feature that will automate the calibration of the Manning's n values. This example will demonstrate how to use this feature. The model used in this example is a portion of the Mississippi River and the Ohio River at their confluence. *While the data is from actual studies, the models and results of this example application do not represent current or future conditions of the system.*

To review the data files for this example, from the main HEC-RAS window, select **File** and then **Open Project**. Go to the directory in which you have installed the HEC-RAS example data sets. From the "Applications Guide\Chapter 24 – Mannings n Calibration" subdirectory, select project titled "Manning's n Calibration." Once opened, this will activate the following files:

Plan:	"Automatic Calibration"
Geometry:	"Mississippi Ohio Junction"
Flow:	"Mississippi Ohio"

### Geometric Data

To view the geometric data for the river system, from the main program window select **Edit** and then **Geometric Data**. This will activate the **Geometric Data Editor** and display the river system schematic as shown in Figure 24.1. The schematic gives a visual representation of the geometric elements entered by the user.

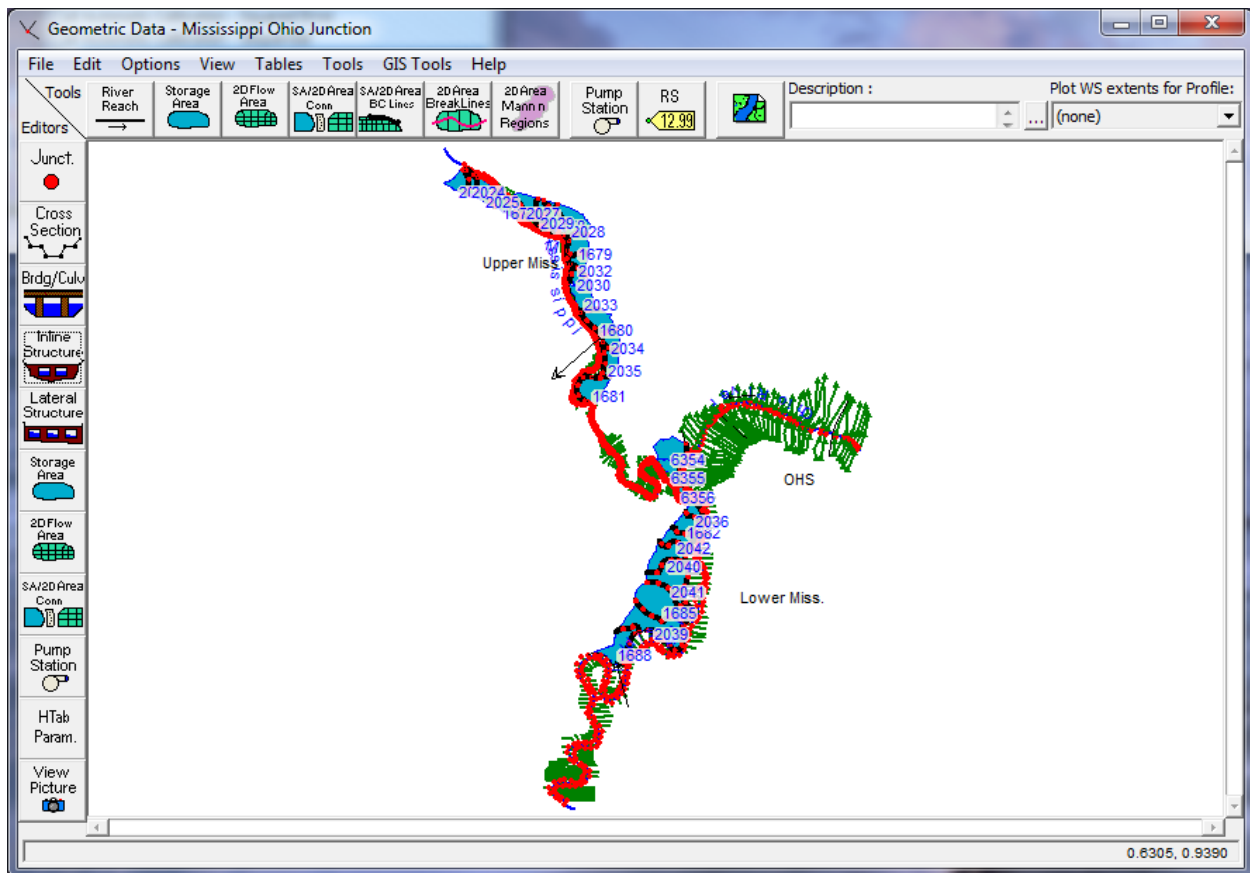

Figure 24-1. River System Schematic for Mississippi Ohio Junction shown within the Geometric Data Editor

### Cross Section Data

The cross section data consists of the X-Y coordinates, Manning's n values, contraction and expansion coefficients, etc. The user can view this data for each river station by selecting the **Cross Section** icon on the left side of the **Geometric Data Editor**. All the data for each cross section was manually entered, an example of which can be seen if Figure 24.2. Levees and ineffective flow areas were added to some of the cross sections. These features are accessed under **Options** of the **Cross Section Data Editor**. Look to Chapter 6 of the User's Manual for more information on entering cross section data.

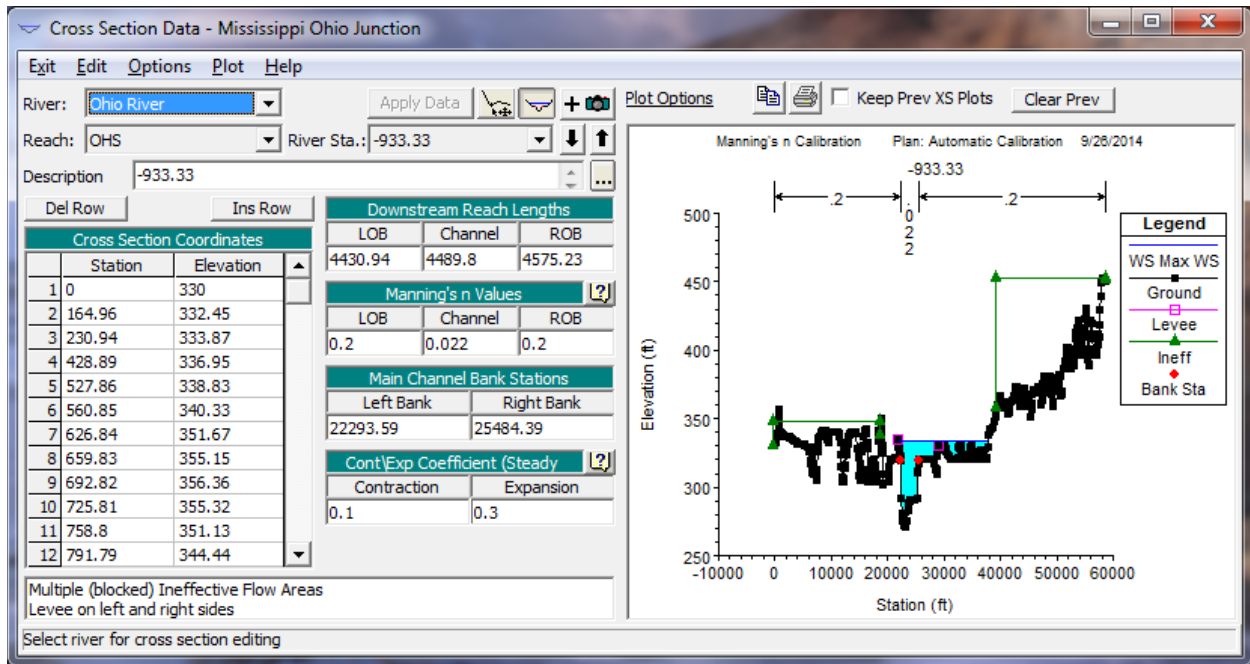

Figure 24-2. Cross Section Data Editor

### Stream Junction Data

Once a junction was established by connecting reaches on the river schematic, junction data was added by clicking on the **Junct** icon from the left side of the **Geometric Data Editor**. This activated the **Junction Data Editor** as shown in Figure 24.3. This model contains one junction that uses the *Energy* method for steady flow computations and *Force Equal WS Elevations* for unsteady flow computations.

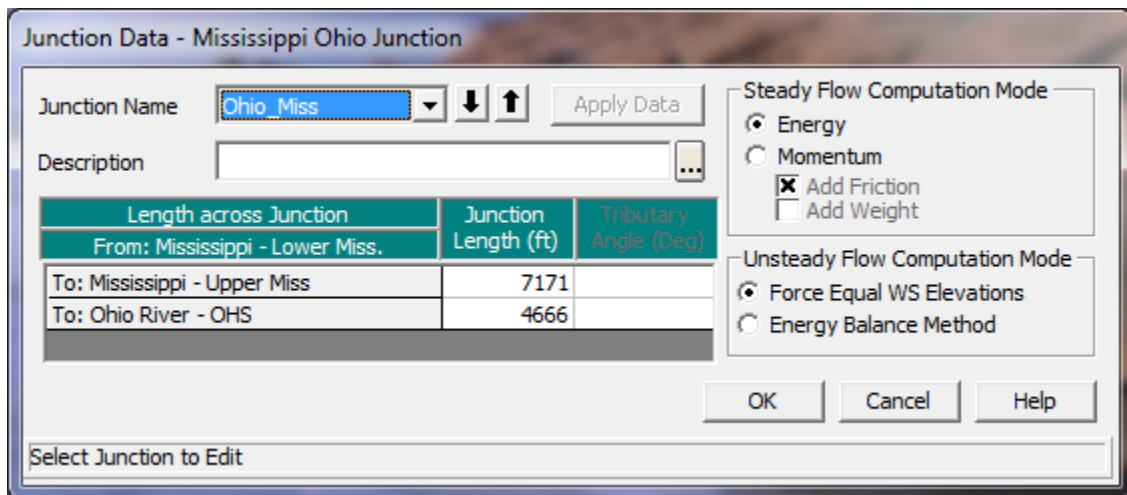

Figure 24-3. Junction Data Editor

## Creating Storage Areas

When creating the storage areas, first the **Storage Area** icon was selected from the **Tools** toolbar (not to be confused with the Storage Area icon from the Editors toolbar) of the **Geometric Data Editor**. The pointer was then placed at the desired location on the river schematic and the storage area was drawn by single clicking and dragging the mouse for each desired point for the storage area. The final point for the storage area was selected by double clicking the mouse. Upon double clicking the mouse, a dialog box appears requesting a storage area name. A name was entered for each storage area created. Points on a storage area may be added or removed by using the **Add Points** to a Reach or SA and **Remove Points** to a Reach or SA options found in the **Edit** menu.

## Entering Data for a Storage Area

After the storage area was drawn in the **Geometric Data Editor** the elevation volume relationship for the storage was established. The data was entered in the **Storage Area Editor**, displayed in Figure 23.4, which is opened by selecting the **Storage Area** icon on the **Editors** toolbar. All the storage areas in this example used the **Elevation versus Volume Curve** to determine a relationship for calculating storage area. This method was selected by clicking the corresponding radio button and then filling in the elevation volume table listed below it (see Figure 23.4).

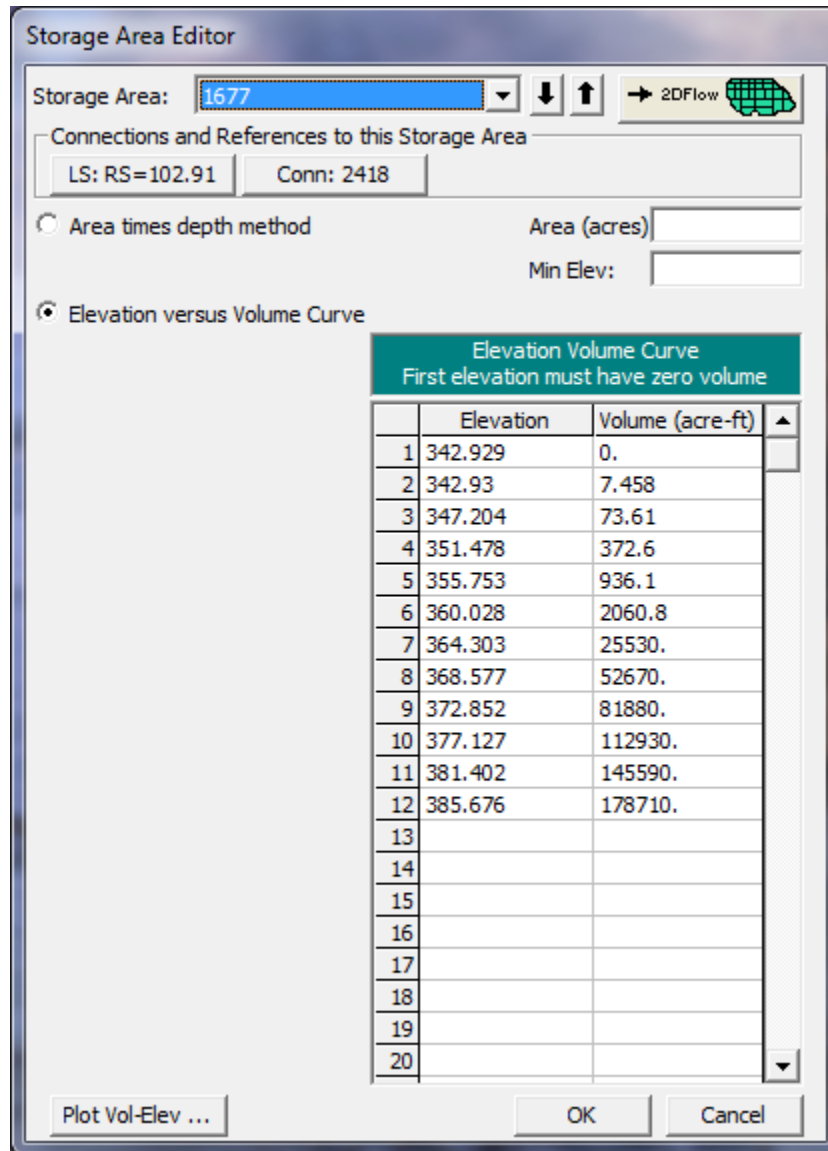

Figure 24-4. Storage Area Editor

### Storage Area Connections

Storage area connections are used to connect storage areas to other storage areas. In this example elevated roadways that divide storage areas are modeled as storage area connections. This feature is used by first selecting the **SA/2D Area Connection** icon from the **Tools** toolbar in the **Geometric Data Editor**. A line can be drawn from one storage area to another by right clicking on the first storage area and then double clicking on the second. A prompt comes up that will ask for the name of the connection. After the user enters a name for the SA connection, it can be selected and edited from the

**SA/2D Area Connection Editor**, which is located on the **Geometric Data Editor** (Figure 24.1).

The storage areas that the connector transferred water to and from were selected by pressing the **Set SA** buttons next to the **From** and **To** location fields. For this example, the **Structure Type** was chosen as *Weir* from the drop down menu for all of the storage area connections. Figure 24.5 shows the Connection Data Editor when illustrating the *Weir* structure types.

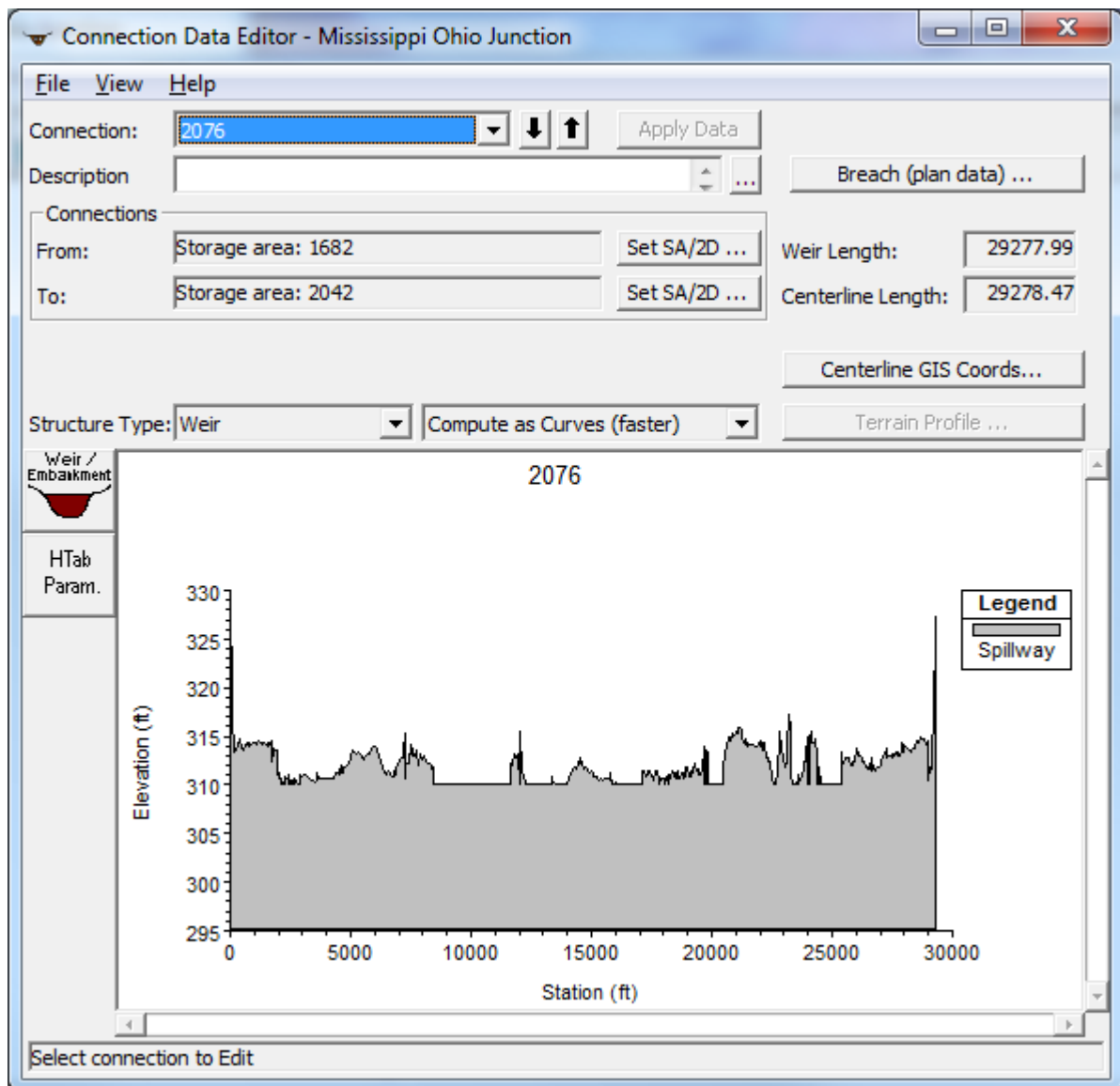

Figure 24-5. Storage Area Connection Data Editor for Weir.

## Lateral Structures

A lateral structure was placed at several river stations throughout the system. This was accomplished by selecting the **Lateral Structure** icon from the **Editors** toolbar in the **Geometric Data Editor**. After selecting the icon, the **Lateral Structure Data Editor** appears, as shown in Figure 24.6. Once the proper reach and river were selected, under the **Options** menu, **Add a Lateral Structure** was selected. HEC-RAS then prompts the user to enter the location of the structure. This placed the beginning of the structure between the cross section river station immediately upstream of the lateral structure river station and the cross section river station immediately downstream of it. The *All Culverts* and *Structure Type* fields were left at their default selections of *No Flap Gates* and *Weir/Gates/Culverts/Diversion Rating Curves* for all of the lateral structures in the system.

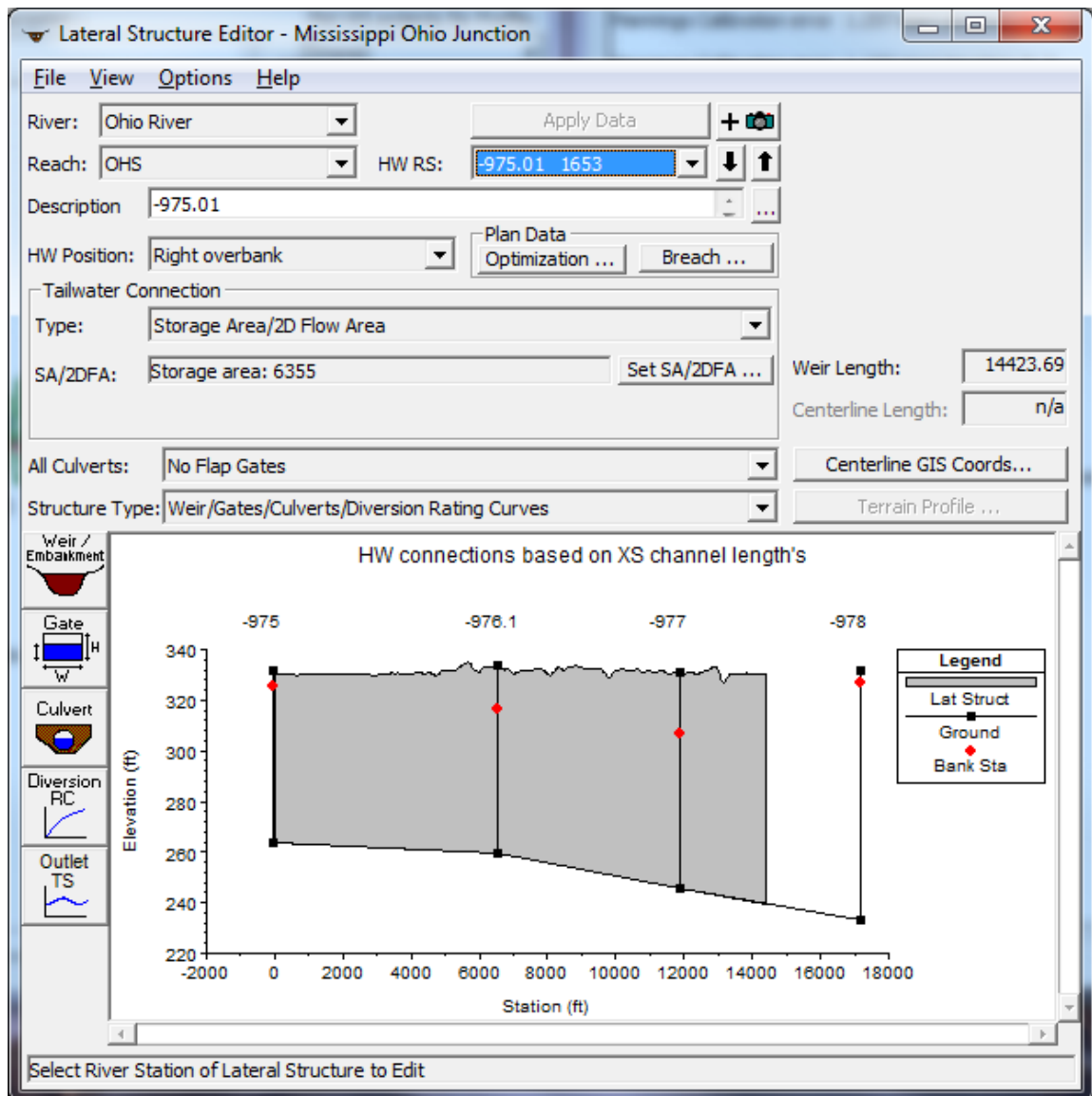

Figure 24-6. Lateral Weir Data Editor

To enter weir data for the structure, the **Weir/Embankment** icon was selected from the **Lateral Structure Data Editor**. The data were entered as shown in Figure 24.7 on the **Lateral Weir Embankment Window**. The editor requires an entry for the following fields: *Weir Width*, *Weir Computations*, *Weir flow reference*, *Weir Coefficient*, *Weir Crest Shape*, *HW Distance to Upstream XS*, and *TW flow goes*. Further description of these fields can be found in Chapter 6 of the User's Manual.

Returning to the **Lateral Structure Data Editor**, the *HW Position* was selected as either "Left overbank" or "Right overbank" from the pull-down menu depending on where the lateral structure resided. The *Tailwater*



Connection Type was chosen as *Storage Area*, meaning that the lateral structure connected the river to a storage area, or *Out of System*, which means that the water leaving the river via the lateral structure is no longer modeled upon leaving. For the *Storage Area* type tailwater connections, an individual storage area was selected to correspond to the lateral structure by clicking the **Set SA/2DFA** button. A window then popped up allowing the user to select a storage area to connect to from a pull-down menu.

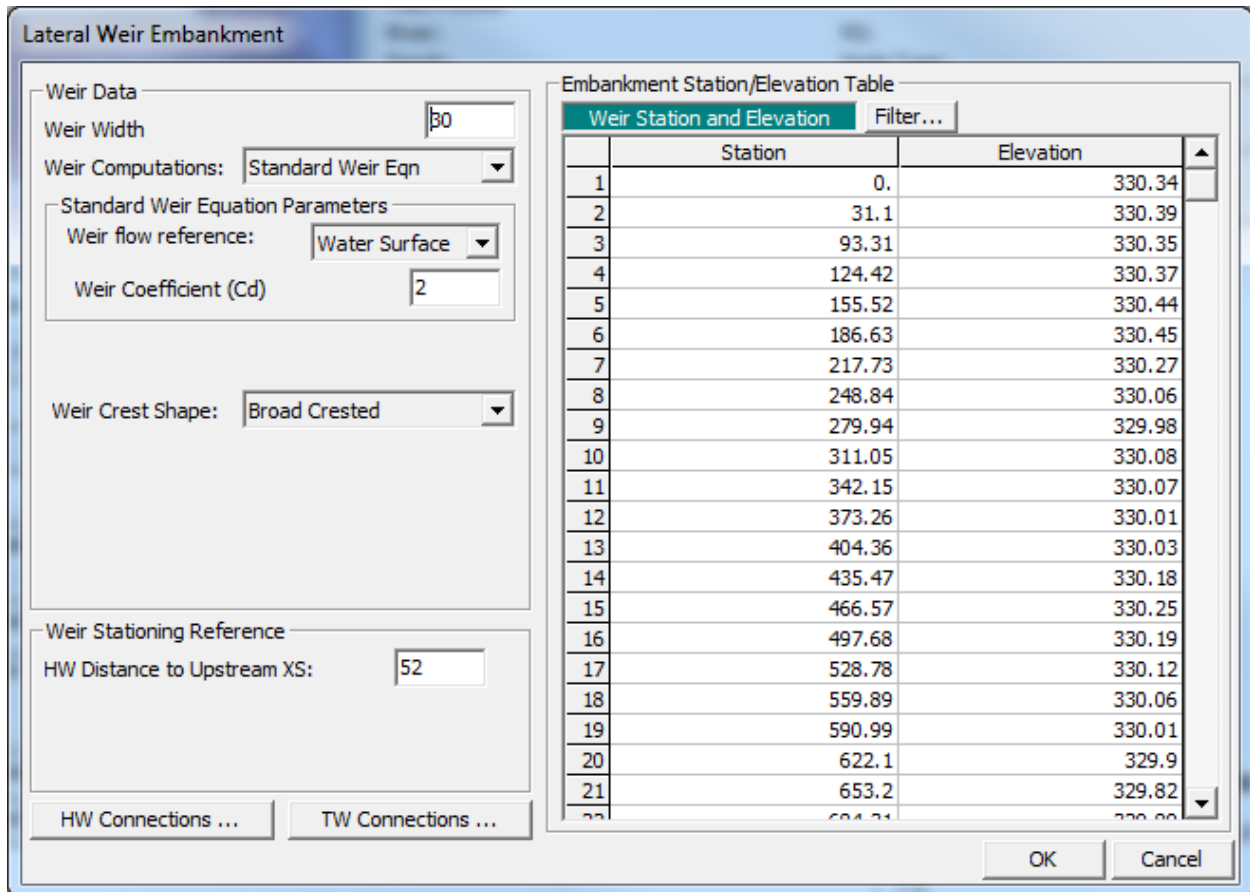

Figure 24-7. Lateral Weir Embankment Editor

### Inline Structure

For this example there were only two inline structures, both of which were on the Ohio River. To add an inline structure, the **Inline Structure** icon was selected from the left side of the **Geometric Data Editor**. This activated the **Inline Structure Data Editor** as shown in Figure 24.8. *Ohio River* was chosen as the river, then, **Options** and **Add an Inline Structure** were selected and the river station was entered as the location for the weir. The

schematic then displayed the cross section data for the river station immediately upstream of the weir location.

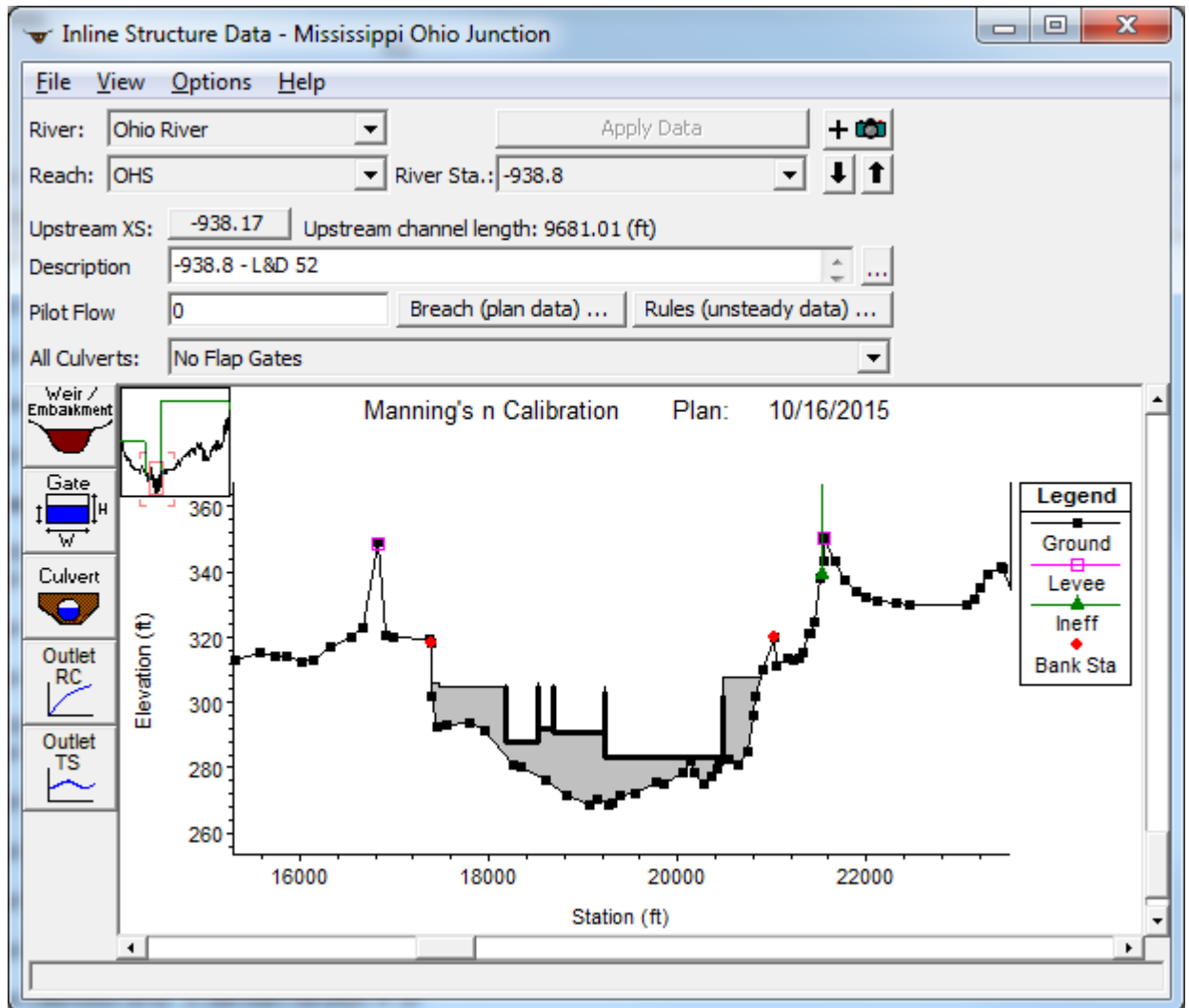

Figure 24-8. Inline Structure Data Editor

Next the weir data was entered. To enter the data for the weir, the **Weir/Embankment** icon was selected from the left side of the **Inline Structure Data Editor**. This activated the **Inline Structure Weir Station Elevation Data Editor** as shown in Figure 24.9. This editor is similar to the deck/roadway editor used for bridges and culverts.

Distance	Width	Weir Coef
3326	30	2.6

Edit Station and Elevation coordinates		
	Station	Elevation
1	17400.	305.74
2	17465.	305.74
3	17465.	304.74
4	18190.	304.74
5	18190.	288.04
6	18515.	288.04
7	18515.	305.74
8	18525.	305.74

U.S Embankment SS: 0      D.S Embankment SS: 0

Weir Data  
Weir Crest Shape  
 Broad Crested  
 Ogee

OK      Cancel

Enter distance between upstream cross section and deck/roadway. (ft)

Figure 24-9.: Inline Structure Station Elevation Data Editor

The top row of the editor consists of three data entry fields. For the first field, the user must enter the *Distance* from the upstream cross section to the upstream side of the weir. Next, the *Width* of the weir was entered (both inline weirs has a width of 30 feet). The last field in the top row of the editor is the *Weir Coefficient* and was entered as 2.6 for both inline weirs, coinciding with the *Broad Crested* weir shape chosen at the bottom of the editor.

The central portion of the editor consists of a table in which the user must enter the station and elevation data for the weir. With these weir stations and elevation, the program will block out the entire area below the weir crest.

To enter the data for the gates, the **Gate** icon was selected from the **Inline Structure Data Editor** (Figure 24.8). This activated the **Gate Editor** as shown in Figure 24.10. Each inline structure had four gates, with each gate belonging to its own gate group. A separate gate group for each gate was created by clicking the *New Gate Group* button (looks like a blank sheet of paper at the top of the editor). The *Gate type (or methodology)* was changed to *Overflow (open air)* from the pull down menu for all gates. The *Weir Shape* was selected as *Broad Crested Weir* and the *Weir Coefficient* was entered as 3. Each gate's geometric properties were entered on the left side of the editor (see Figure 24.10). The **OK** button was selected at the bottom of the **Gate Editor** and the gates appeared on the **Inline Structure Data Editor**

as shown in Figure 23.10. The **Inline Structure Data Editor** was then closed.

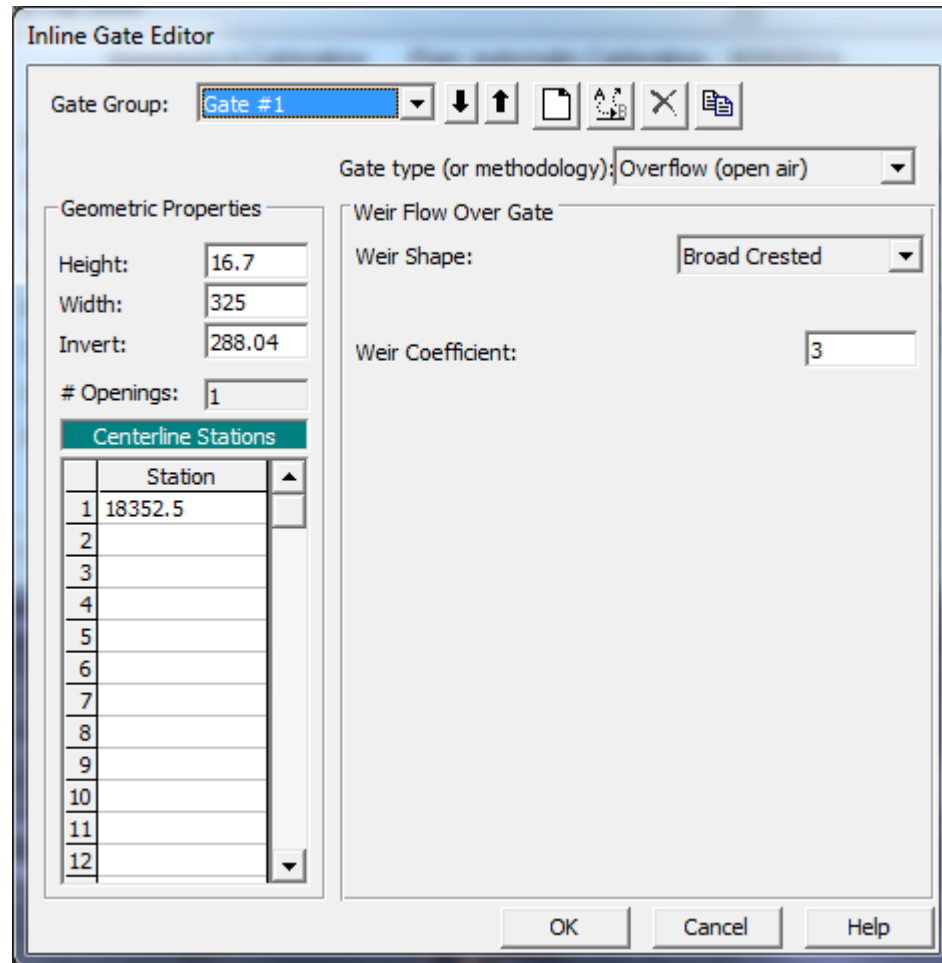

Figure 24-10. Inline Gate Editor

### Cross Section Table Parameters

In HEC-RAS, cross sections are processed into tables of elevation versus hydraulic properties of areas, conveyances, and storage. The user is required to set an interval for spacing the points in the cross-section tables. In the **Geometric Data Editor** the icon **Htab Parameters** was selected under the **Editors** toolbar. This displays the **Cross Section Table Parameters Window** shown in Figure 24.11. The starting elevation, table increment, and number of points columns are automatically filled by the program but may be changed by the user. The program automatically starts the table for each cross section one foot above the channel invert. The program chooses a table

increment and number of points by first attempting to use 20 points, and choosing an increment that will put the table up to the top of the cross section. If this results in too large of an increment (greater than 1.0 foot) the program will use a one foot increment and add additional points to get the table to the top of the cross section. In this example, since the Mississippi River and Ohio River are very large rivers that have significant variations in stage, the maximum number of points (500) had to be used and the increment was greater than 1.0 at some river stations. The user can set individual values for each cross section if it is deemed necessary. **Warning: Always ensure that your cross section tables encompass the complete range of stages that will be modeled.** If the tables do not go up to a high enough elevation, the program will have to extrapolate during the computations. More often than not, the extrapolation causes instabilities in the results. To visualize the extent of the tables, a graphic of individual cross sections is shown on the right hand side of the window. The graphic displays the cross section corresponding to the row in which you cursor lies in the table.

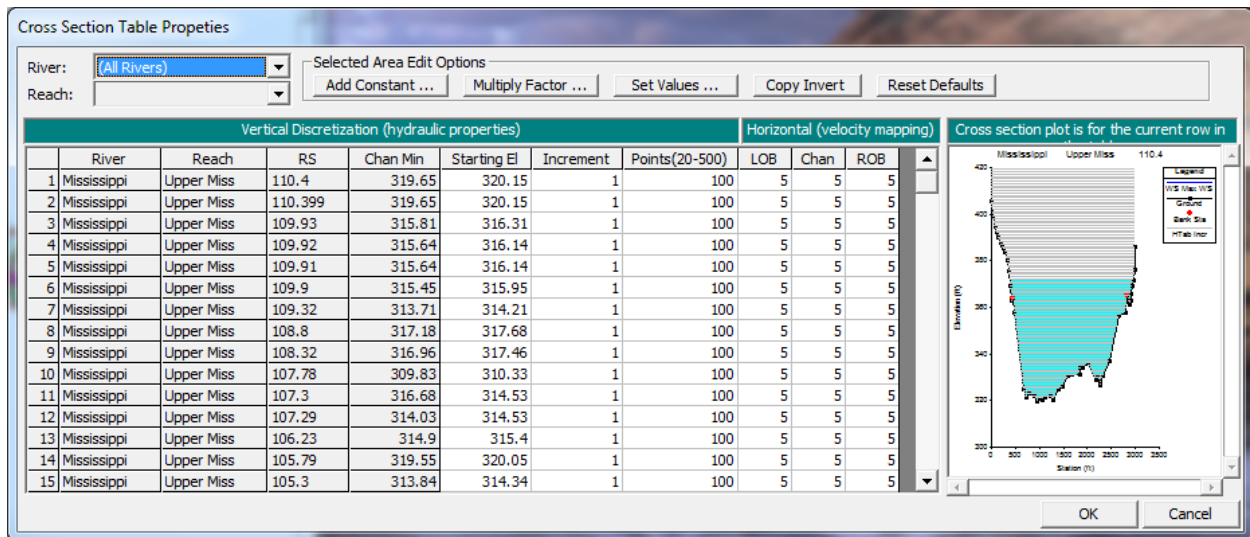

Figure 24-11. Cross Section Table Parameters

## Unsteady Flow Data

The user is required to enter boundary conditions and initial conditions for the system at the beginning of the simulation period. For additional information on unsteady flow data refer to Chapter 8 of the User's Manual, Performing an Unsteady Flow Analysis. The **Unsteady Flow Data Editor**, shown in Figure 24.12, was selected from the main program window under the **Edit** menu.

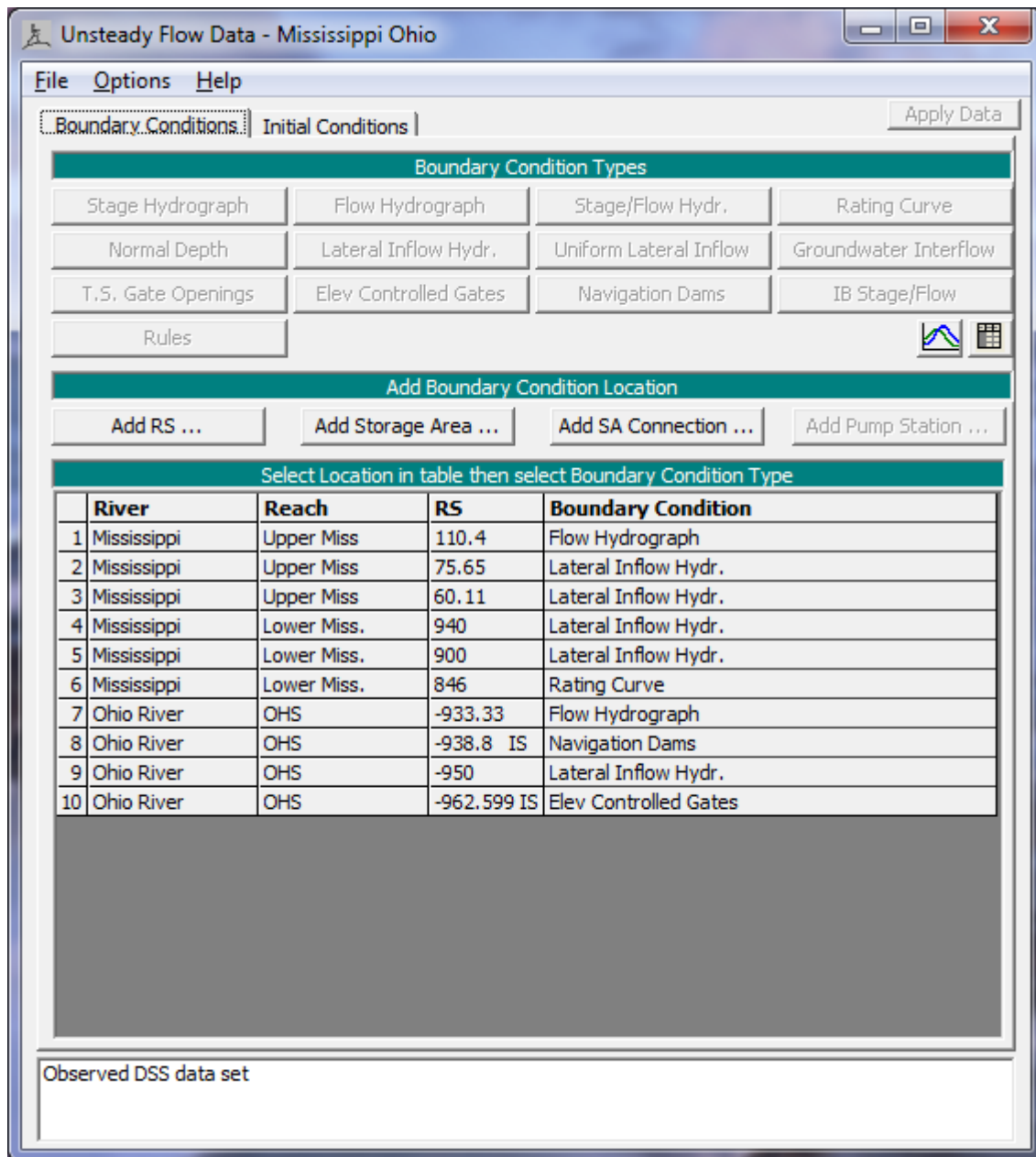

Figure 24-12. Unsteady Flow Data Editor

## Boundary Conditions

Boundary conditions are required for the farthest upstream and downstream cross sections of the river system. Upon entering the **Unsteady Flow Data Editor** the farthest upstream and downstream cross sections will automatically be located in the boundary conditions column. In addition, features such as gated inline structures, which also require a boundary

condition, will automatically be populated in the *Boundary Condition* table. In this example there are 10 total boundary conditions: two upstream BC, one downstream BC, and seven internal BC.

Boundary conditions are set by highlighting the adjacent cell under **Boundary Condition Type**. When a cell is highlighted, not all boundary conditions are available. The program will automatically gray out all irrelevant boundary condition types. Internal boundary conditions may be added by selecting one of the buttons under the "Add Boundary Condition Location" heading.

### Upstream Boundary Conditions

The two upstream boundary conditions used a flow hydrograph that was selected by highlighting the *Boundary Condition* cell and pressing the **Flow Hydrograph** button. The window where the **Flow Hydrograph** data is entered is shown in Figure 24.13. The user may select to read hydrograph data from a DSS file or manually enter the flow data in the table provided. For this example the flow hydrograph was manually entered for RS -933.33 of the Ohio River while a DSS file was read in for the upstream BC for the Upper Mississippi.

For River Station -933.33 of the Ohio River, the **Data Time Interval** was set to six hours and the radio button **Use Simulation Time** was selected. The **Use Simulation Time** option starts the hydrograph at the beginning of the simulation time window, which is discussed in an upcoming section. The hydrograph was then manually entered after first clicking the **Enter Table** radio button.

**Flow Hydrograph**

River: Ohio River Reach: OHS RS: -933.33

Read from DSS before simulation Select DSS file and Path

File:

Path:

Enter Table Data time interval: 6 Hour

Select/Enter the Data's Starting Time Reference

Use Simulation Time: Date: 25sep2004 Time: 12:00

Fixed Start Time: Date:  Time:

No. Ordinates

Hydrograph Data			
	Date	Simulation Time (hours)	Flow (cfs)
1	25Sep2004 1200	00:00	432819.9
2	25Sep2004 1800	06:00	468577.1
3	25Sep2004 2400	12:00	456901.4
4	26Sep2004 0600	18:00	394603.5
5	26Sep2004 1200	24:00	365641.8
6	26Sep2004 1800	30:00	343035.3

Time Step Adjustment Options ("Critical" boundary conditions)

Monitor this hydrograph for adjustments to computational time step

Max Change in Flow (without changing time step):

Min Flow:  Multiplier:

Figure 24-13. Flow Hydrograph for Upstream Boundary Condition

The flow hydrograph associated with the upper reach of the Mississippi River (RS 110.4) differed from the Ohio River upstream boundary condition in that it pulled its flow information from a DSS file. A DSS file was connected to the RS by pressing the button **Select DSS file and Path**. When this button was pressed a DSS file and pathname selection screen appeared as shown in Figure 24.14. The desired DSS file was found and selected by using the browser button at the top. Once the DSS file was selected, a list of all of the DSS pathnames within that file was displayed in the table. The pathname filters were used to reduce the number of pathnames shown in the table. When the desired DSS pathname was found the window was closed and the filename and pathname will be recorded in the **Flow Hydrograph Window**.



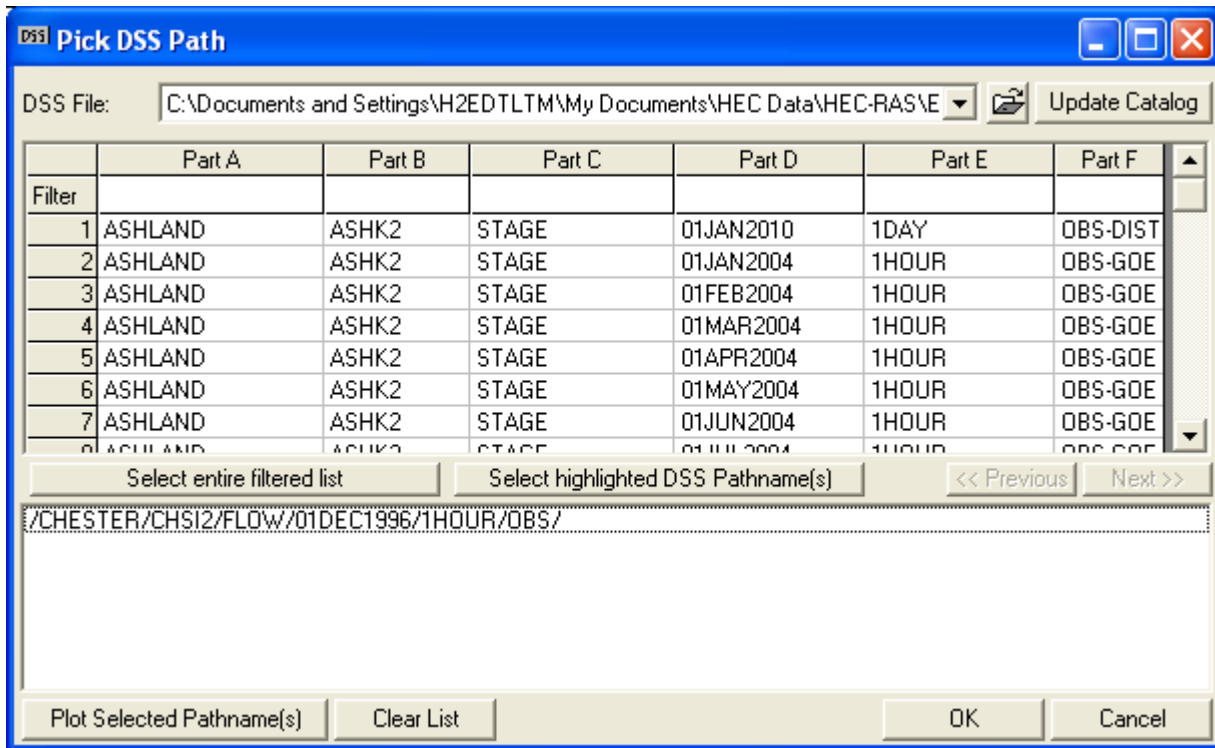

Figure 24-64. DSS Pathname and Filename

### Downstream Boundary Condition

The boundary condition selected for RS 846 of the Lower Mississippi was a rating curve. Again, the corresponding cell for that particular river station was highlighted and then the **Rating Curve** button was selected. A window appeared as seen in Figure 24.15 where the radio button **Enter Table** was clicked and the stage and flow values were manually entered.

River: Mississippi Reach: Lower Miss. RS: 846

Read from DSS before simulation Select DSS file and Path

File:

Path:

Enter Table

Del Row    Ins Row

Hydrograph Data		
	Stage (ft)	Flow (cfs)
1	211.	0.
2	225.8	80000.
3	227.5	92000.
4	229.8	116000.
5	231.1	131000.
6	232.7	152000.
7	235.	189000.
8	240.	299000.
9	241.2	328000.
10	243.3	373000.
11	243.4	377000.
12	246.1	436000.
13	248.9	517000.
14	249.6	541000.
15	250.6	570000.
16	251.2	593000.

Plot Data    OK    Cancel

Figure 24-75: Rating Curve Data Editor

### Internal Boundary Conditions

Internal boundary conditions were entered for the gates of the two inline structures and to represent un-modeled tributaries. The inline structure at RS -938.8 of the Ohio River utilized "Navigation Dams" BC, while the inline structure at RS -962.599 used the "Elev Controlled Gates" BC. The data for these two BC were entered as seen in Figure 24.16. For more information on entering data for *Elev Controlled Gates* or *Navigation Dams* see Chapter 8 and 16 of the User's Manual.

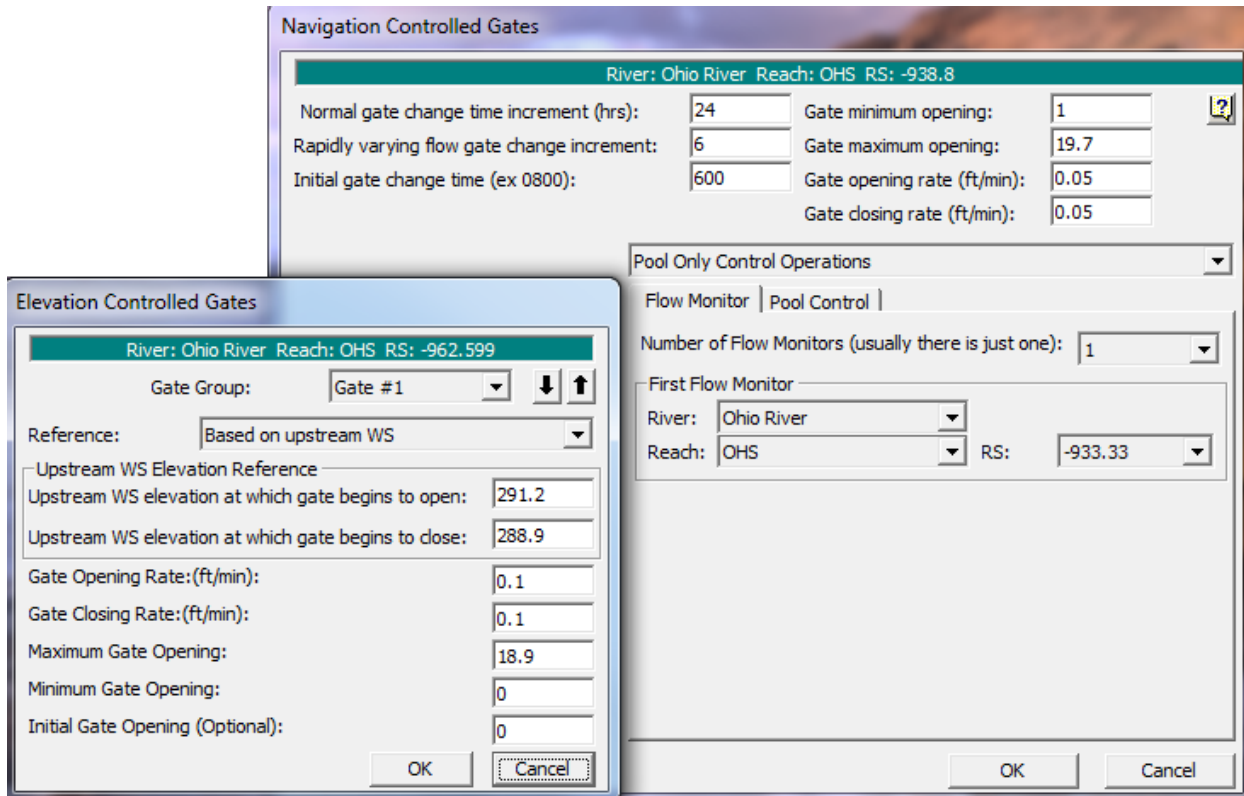

Figure 24-16. Elevation Controlled Gates and Navigation Controlled Gates Editors

Lateral inflow hydrographs were added throughout the river reaches as a means of representing flow from an un-modeled tributary. This is often done when there is un-modeled tributary flow that has a noticeable impact on the modeled system but the impact of the modeled floodwave on the tributary is not considered to be within the scope of the model's objective. Therefore, the effects of the flow are captured without having to model unnecessary parts of the system. For all five of the lateral inflow hydrographs used in this example, the hydrograph was read in from DSS. This was done in the same manner as was the flow hydrographs for the upstream BC (explained above).

### Initial Conditions

Initial conditions consist of flow information at each of the cross sections, as well as elevations for any storage areas defined in the system. Data for initial conditions is established by selecting the **Initial Conditions** tab on the **Unsteady Flow Data Editor**. After selecting the tab, Figure 24.17 will be displayed.

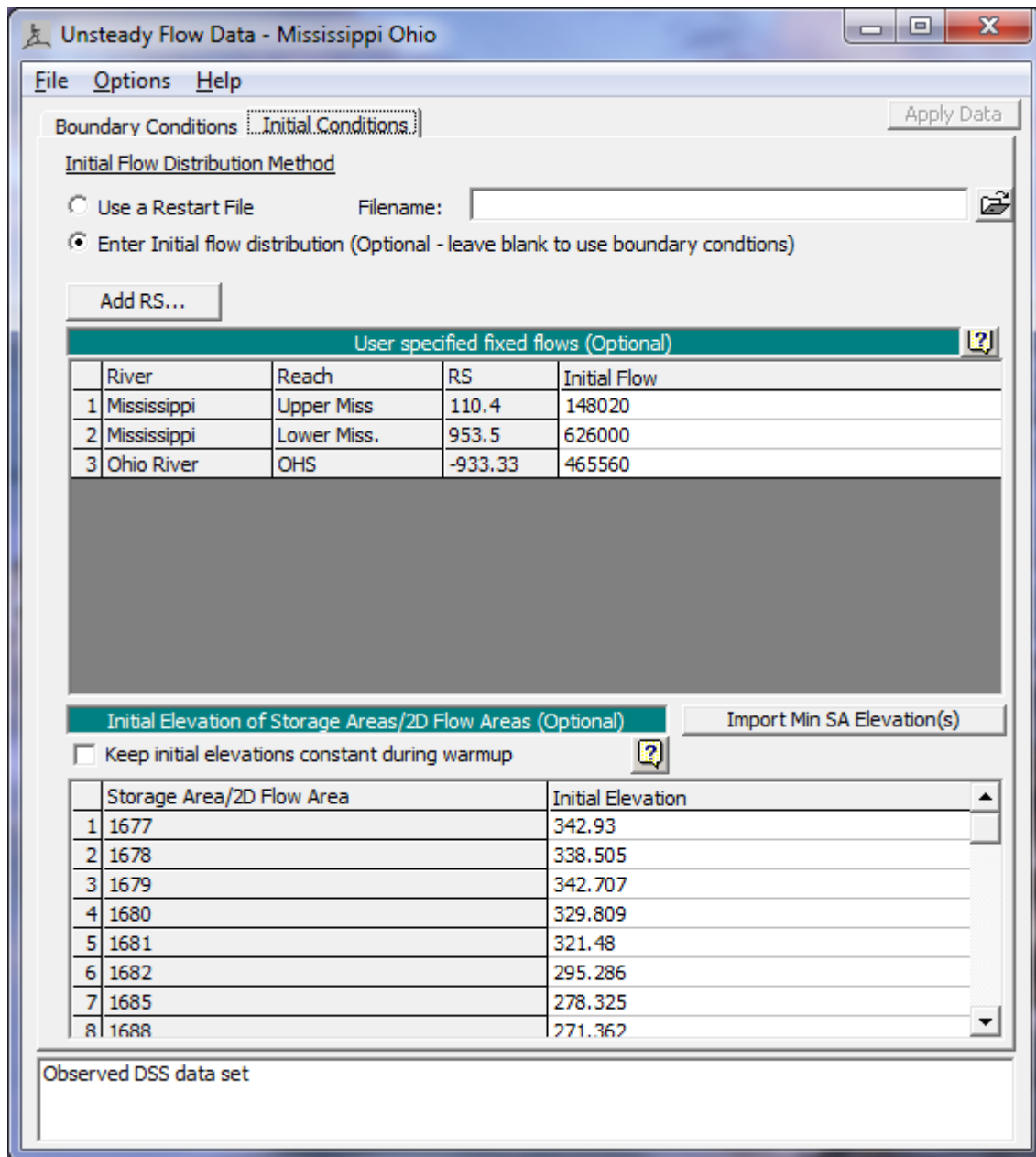

Figure 24-17. Unsteady Flow Data Initial Conditions

As seen in Figure 24.17, the **Enter Initial flow distribution** radio button was selected and initial flows were entered at the upstream river station of each of the three reaches. The initial water surface elevation of all twenty-seven storage areas was set as well. The data was then saved (**File -> Save Unsteady Flow Data As**) in the **Unsteady Flow Data Editor** and the window was closed.

## Unsteady Flow Analysis

After the geometry and unsteady flow data have been completed an unsteady flow analysis may be initiated. Under the main program window **Unsteady Flow Analysis** was selected under the **Run** menu. This displayed the **Unsteady Flow Analysis Window** shown in Figure 24.18. A plan was defined by selecting the Geometry File "Mississippi Ohio Junction" and the Unsteady Flow File "Mississippi Ohio." Under the **File** menu, **Save Plan As** was selected and the plan title was entered as "Automatic Calibration." After entering the title of the plan a short identifier was entered as "AutoCalibrate" and the plan was saved. The data was entered as seen in Figure 24.18 below. For more information on the *Simulation Time Window*, *Computation Settings*, and *Programs to Run* refer to *Unsteady Flow Application – Example 17*.

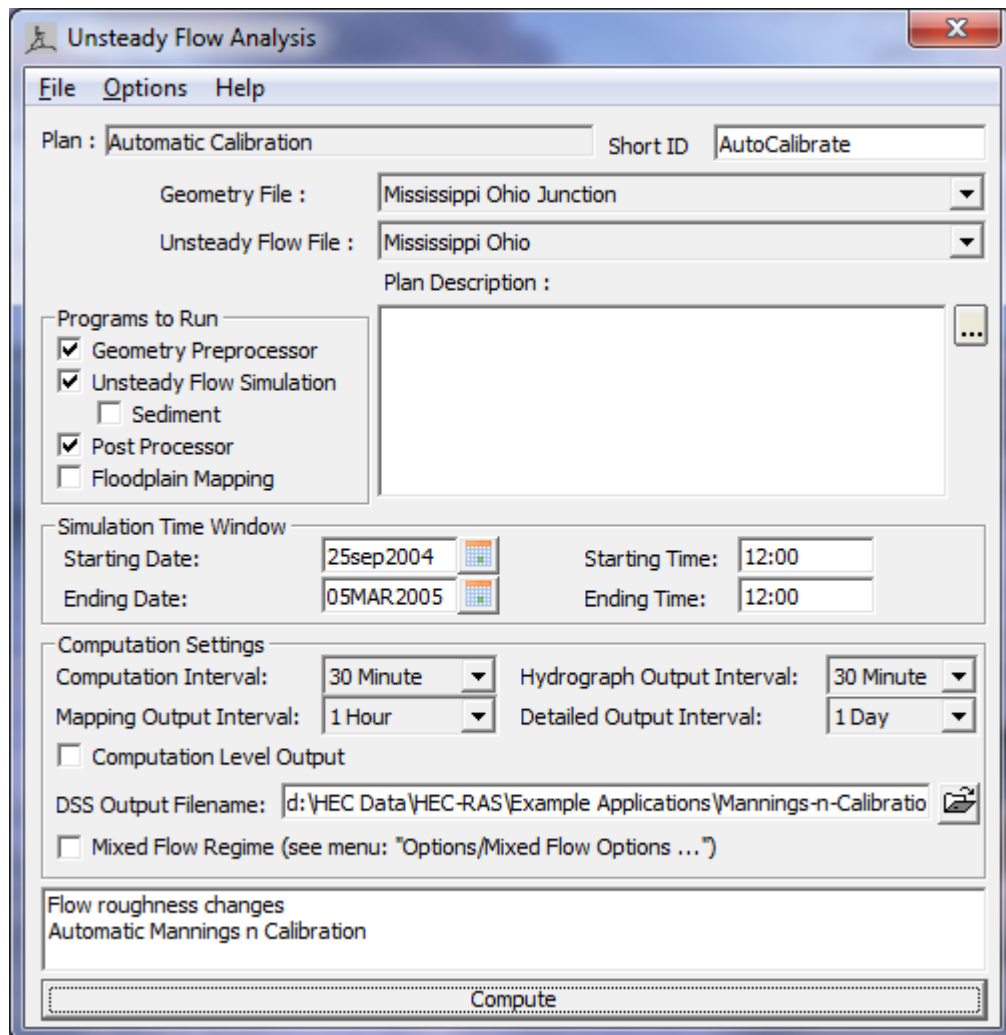

Figure 24-18. Unsteady Flow Analysis

## Calibration of Manning's n Values

In an effort to ensure a higher level of model accuracy, the user can calibrate the model when reliable gage data is available. Often times the primary focus of calibration is the adjustment of Manning's n values. However, before the user begins adjusting any Manning's n values they should consider the following:

- If the model is predicting stages that have a large degree of variance from the historic events, the users should also evaluate the hydrologic data and the geometric data to ensure that it is correct. Things such as incorrect hydraulic structure coefficients or flow data can make a significant impact on the results.
- Manning's n values should initially be determined using a combination of site visits, aerial photography, topographic maps, experience, etc. The initial estimate for Manning's n values should be used as a baseline for reasonable values when calibrating. If the calibrated n values are drastically different from the initial values, the user should critically evaluate the model to find any possible errors or mistaken assumptions. *Do not proceed with calibration using unreasonable or unrealistic Manning's n values.*

### Adding Observed (Measured) Data

As alluded to previously, in order to calibrate Manning's n values in HEC-RAS the user must have a reliable and accurate gage(s) within the system. In this example nine time-series DSS gages were used – three for each reach. Gages can be added from the **Options** menu of the **Unsteady Flow Data Editor**. Under *Options* the user can select three types of observed data from **Observed (Measured) Data**: *Time Series in DSS, High Water Marks, or Rating Curves (Gages)*.

In this example the **Time Series in DSS** option was selected. Once selected, a window appeared titled "**Set Locations and Paths for Observed Data in DSS**" that allows the user to match a DSS file to a river location (see Figure 24.19). The river and river station were chosen from the three drop down menus at the top of the window: *River, Reach, and River Sta*. Once the correct location was set, the **Add selected location to table** was clicked and the location was added to the table below. Next, the DSS file was added from the **DSS File** option (middle of the window). When the DSS file was connected, the table below was automatically populated with the DSS file pathnames, which contained the observed values.

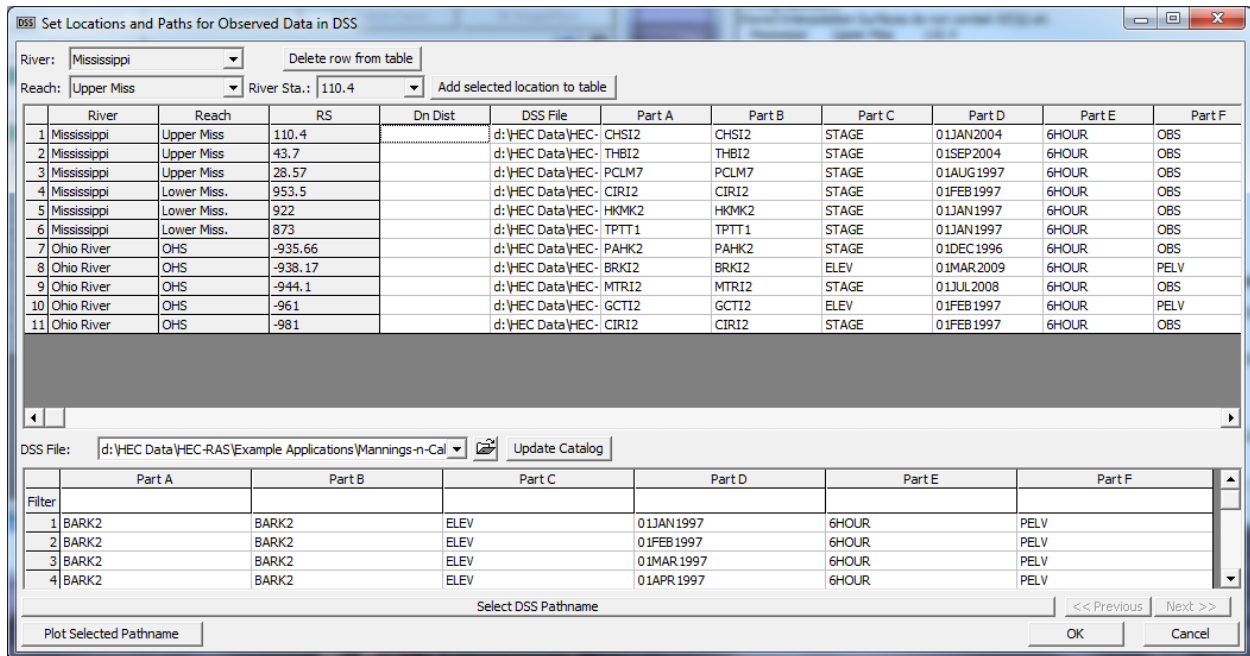

Figure 24-19. Observed (Measured) Data Editor – DSS Time Series

Finally, the appropriate DSS file and pathname was connected to each individual RS in the top table by highlighting the desired row and then selecting the corresponding gage data (pathname) from the bottom table. The information from the pathname selected in the bottom table should then be populated in the highlighted row in the top table. In this example, Part A, Part B, and Part C columns of the DSS file tell the user which gage location and data type (stage, flow, etc.) the user is selecting. It is important that the user is careful to match the DSS file with the correct location and required data type. However, matching column Part D, which has the time that the data begins, is not pertinent. It is not required that the date listed in Part D for the row that the user selected fall within the simulation time of the model. As long as the gage has collected data during the simulation time frame, HEC-RAS will automatically find the corresponding gage times. The pathname data can be visually inspected by clicking the **Plot Selected Pathname** button in the lower left hand corner of the window.

### Calibration of Base Manning's n Values

Once all the Manning's n values have been entered for each cross section, the observed data has been entered, and the plan has been processed, the user can evaluate the output to determine if the base Manning's n values need to be adjusted to better match the observed conditions. In this example, some of the RS with gage data calculated stage values that were either consistently above or below the observed values. This indicated that all of the Manning's n values near that RS needed to be adjusted either up or down, depending on whether it over- or under-estimated the river stage.

The Manning's n values can be easily manipulated by opening **Manning's n or k values (Horizontally varied)** from the **Tools** menu of the **Geometric Data Editor**. Figure 24.20 will then appear and the desired River and Reach can be selected, as well as the region of the river (in this case *All Regions* was always selected).

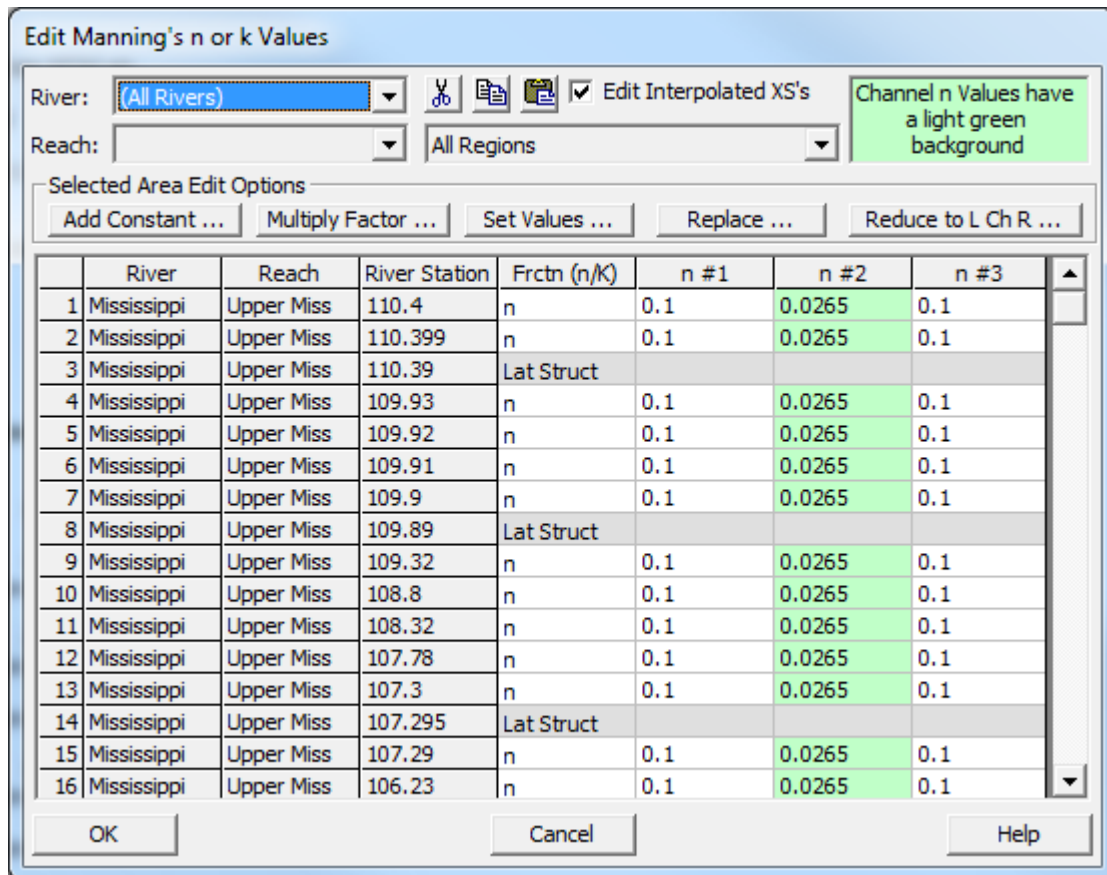

Figure 24-20. Manning's n Table Editor

If it were the case that the stage values were consistently too low for RS 43.7 of the Upper Mississippi River, the channel (highlighted in green) and overbank Manning's n values near RS 43.7 could be selected and adjusted upward by a factor of 1.05 by clicking the **Multiply Factor** from the *Selected Area Edit Options* above the table. This would increase all of the highlighted Manning's n values by 5%. This change would increase the stage near and upstream of RS 43.7 when the plan was reprocessed. Alternatively, the *Add Constant* or *Set Values* could have been selected to change the Manning's n values.



## Automatic Calibration of Manning's n

Manually calibrating base Manning's n values can often times be a tedious, challenging (especially if it is a complex system), or even impossible task. Occasionally, simulated flow hydrographs will overestimate at some portions of the hydrograph while underestimating at other portions at the same river station, making it impossible to calibrate the values at all locations, for all flow rates (low to high). This can be due to stream geometry variations during different times/seasons or could be due to variances in stream behavior during different flow rates. Both of these factors can be accounted for through the **Options** menu of the **Unsteady Flow Analysis**. However, for this example only the **Flow Roughness Factors** tool (seen in Figure 24.21) will be evaluated since the user is required to create flow roughness factors when using the automated calibration procedure. *Note: The flow roughness factors can also be accessed from the **Tools** selection of the **Geometric Data Editor's** menu. However, accessing it from the Geometric Editor will relate the flow roughness factors to the geometry file and not the plan file. Although either set of flow roughness factors can be used for automated calibration, the user should beware of this distinction and use the option according.*

Once the Flow Roughness Factor Editor was opened, the first thing that was done was to divide each river reach into segments that correspond to each gage. Typically, it is ideal to have the gage at the upstream portion of each river segment. For example, the gage at 43.7 of the Upper Mississippi had a corresponding river segment ranging from the upstream RS of 43.7 to the downstream RS 29.09 (immediately upstream of the next gage). This was done by selecting *Mississippi, Upper Miss, 43.7, and 29.09* from the *River, Reach, Upstream Riv Sta, and Downstream Riv Sta* dropdown menus, respectively. As seen in Figure 24.21, flow values were entered in the bottom table so that all possible flows were accounted for in the table. Next, a corresponding roughness factor was entered for each flow value. After the table was filled in, the **Add** button was selected and the other river segments were created in the same manner.

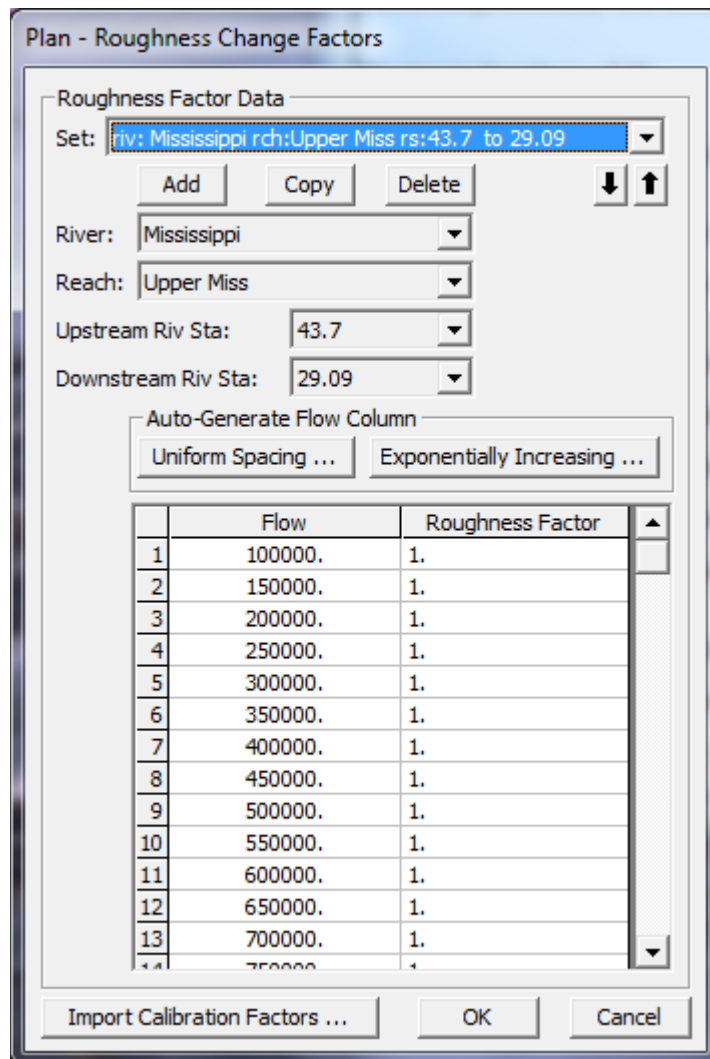

Figure 24-21. Flow Roughness Factor Editor

As mentioned earlier, the automated calibration procedure computes adjustments to existing flow roughness factors to follow observed stages. An initial set of flow roughness factors must already be set in the geometry or plan and the observed stages must already be in the unsteady flow data before implementing this calibration procedure. In this example, the initial flow vs. roughness factors are all being set to a value of 1.0 (no change to the base  $n$  values), since the automated calibration process will be computing flow vs roughness factors for us. After the initial set of flow versus roughness factors were set up for all of the reaches to be calibrated, the **Automated Roughness Calibration** tool was accessed from the **Options** menu of the **Unsteady Flow Analysis Editor**. The *Unsteady Roughness Calibration Editor* appears as in Figure 24.22. There are four distinct regions within the editor: *Calibration Parameters*, *Calibration Regions*, *Forcing Internal Observed Flows*, and *Forcing Internal Observed Stages*. The last two are not thoroughly

discussed in this example because they were not used. The user is encouraged to look to Chapter 16 of the User's Manual for more information on the *Unsteady Roughness Calibration Editor*.

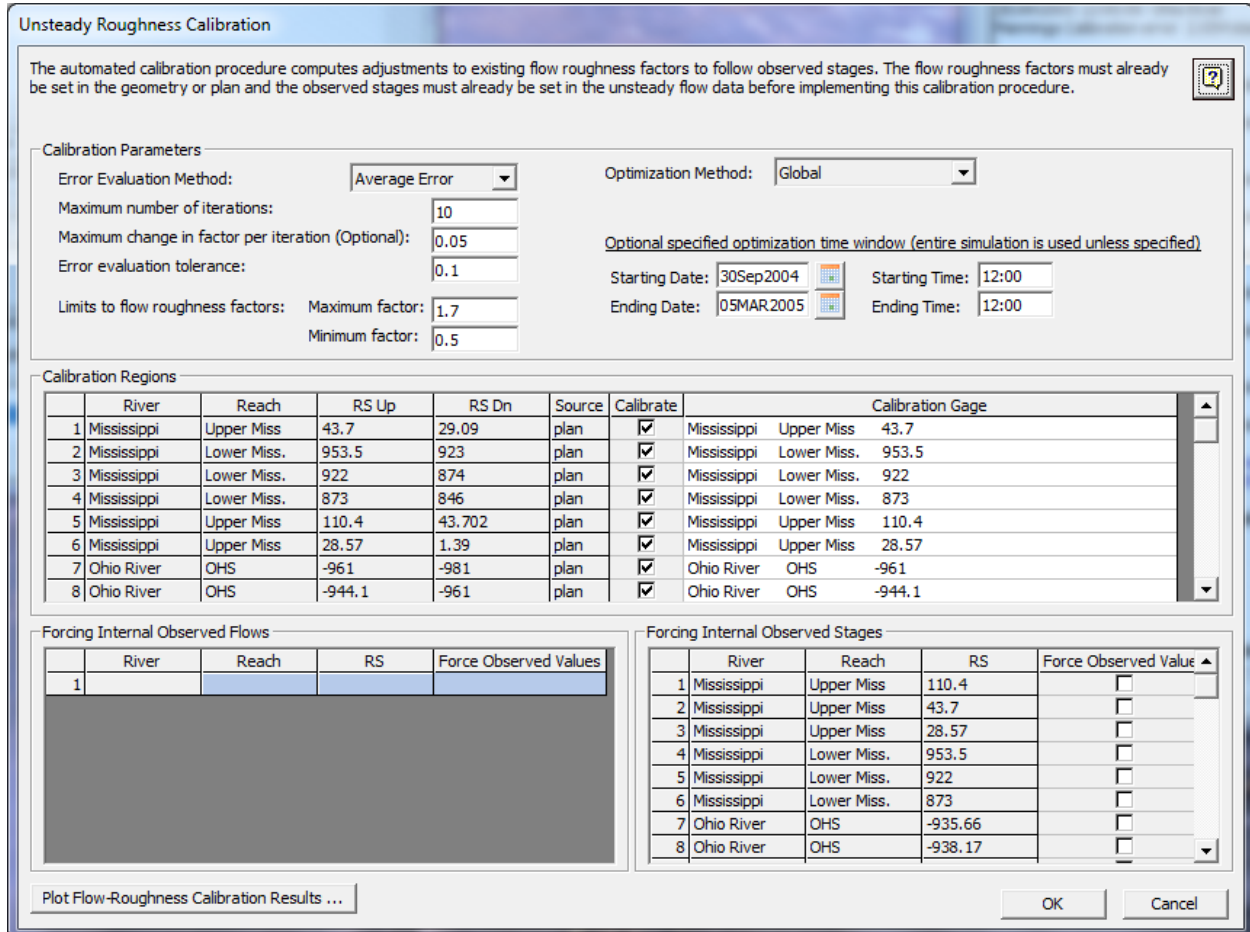

Figure 24-8. Manning's n Automated Calibration Editor

First, the fields within the *Calibration Parameters* region were entered. The Optimization Method was set to *Global*. The other possible selection from the dropdown was the sequential method. The sequential method can potentially lead to better results; however, it takes much longer to run because it goes through many more iterations. Computationally, the primary distinction between the two methods is that the global method calibrates all Manning's n values simultaneously, whereas the sequential method calibrates the upstream river stations first and then works its way down to the lower river stations. Also, for sequential method calibration, the bottom two regions – *Forcing Internal Observed Flows* and *Forcing Internal Observed Stages* – must be used; however, they are not used with the global method.

Next, the remaining fields within the Calibration Parameters were filled in. The *Error Evaluation Method* was set to *Average Error* for this example. The

*Maximum number of iterations* and *Maximum change in factor per iteration* were set to 10 and 0.05, respectively. The iteration tolerance is the acceptable convergence error, which basically tells the program what amount of error the user is comfortable with and when to stop running. This value was set to 0.1 for this example. In layman's terms - for the entries of this example - these parameters tell the program that it has up to ten attempts to get an error under 0.1 while adjusting the factors by no more than 0.05 (5%) on any iteration and keeping its estimates within a range of 0.5 and 1.7. The limit placed on the amount changed per iteration is used to keep the program from overshooting the best answer, while the range ensures that the final answer isn't something unreasonable. An optional time window was also used for this example. The start date was five days after the simulation time and ended at the same time as the simulation (25 Sep 2004 – 05 Mar 2005). This function can be used if the user doesn't want to evaluate a certain portion of the flow hydrograph.

The *Calibration Regions* portion of the window was completed next. This area was already populated with the roughness factor river segments that were created earlier. Under the *Calibration Gage* column, a gage was paired with the river segment that it corresponded to by selecting the cell and then choosing the appropriate gage from a drop down menu that appeared. Lastly, each box under the *Calibrate* column heading was checked on.

The **OK** button was clicked and the Unsteady Flow Analysis was run. After the model ran, the new calibrated Manning's n values can be found by reopening the **Unsteady Roughness Calibration Editor** and clicking the **Plot Flow-Roughness Calibration Results** button in the lower left hand corner of the window. A DSS plot will appear (see Figure 24.23) that displays pre- and post-calibration roughness factors. The first tab plots the data, while the second tab (as seen in Figure 24.23) displays the results in a table. If the user is satisfied with the calibrated roughness factors, they can copy and paste them into the *Flow Roughness Factor Editor* so that the new values will be used in the next run.

	MISSISSIPPI LOWER MISS. 953.5 TO 923		MISSISSIPPI LOWER MISS. 953.5 TO 923	
	FLOW	ROUGH	FLOW	ROUGH
	CFS	MANN	CFS	MANN
1	100000.00	1.00	100000.00	1.17
2	200000.00	1.00	200000.00	1.17
3	300000.00	1.00	300000.00	1.09
4	400000.00	1.00	400000.00	1.12
5	500000.00	1.00	500000.00	1.08
6	600000.00	1.00	600000.00	1.09
7	700000.00	1.00	700000.00	1.07
8	800000.00	1.00	800000.00	1.09
9	900000.00	1.00	900000.00	1.04
10	1000000.00	1.00	1000000.00	1.09
11	1100000.00	1.00	1100000.00	1.09
12	1200000.00	1.00	1200000.00	1.07
13	1300000.00	1.00	1300000.00	1.06

Figure 24-23. DSS Table of Pre- and Post-Calibration Roughness Factors

## Output Analysis

The best way to check the validity of the calibrated hydrograph and the impact of the adjustment in roughness factors is by comparing the pre- and post-calibrated stage and flow hydrographs.

### Stage and Flow Hydrographs

The stage and flow hydrographs can be opened by choosing **Stage and Flow Hydrographs** from the **Run** selection of the main menu bar. The observed stage (black line with diamonds), calibrated stage (blue line), and the originally calculated stage (red line) can be seen in Figure 24.24. As seen in the figure, the calibrated hydrograph nearly perfectly matches the observed hydrograph, whereas the original, uncalibrated hydrograph is consistently underestimating the gage values.

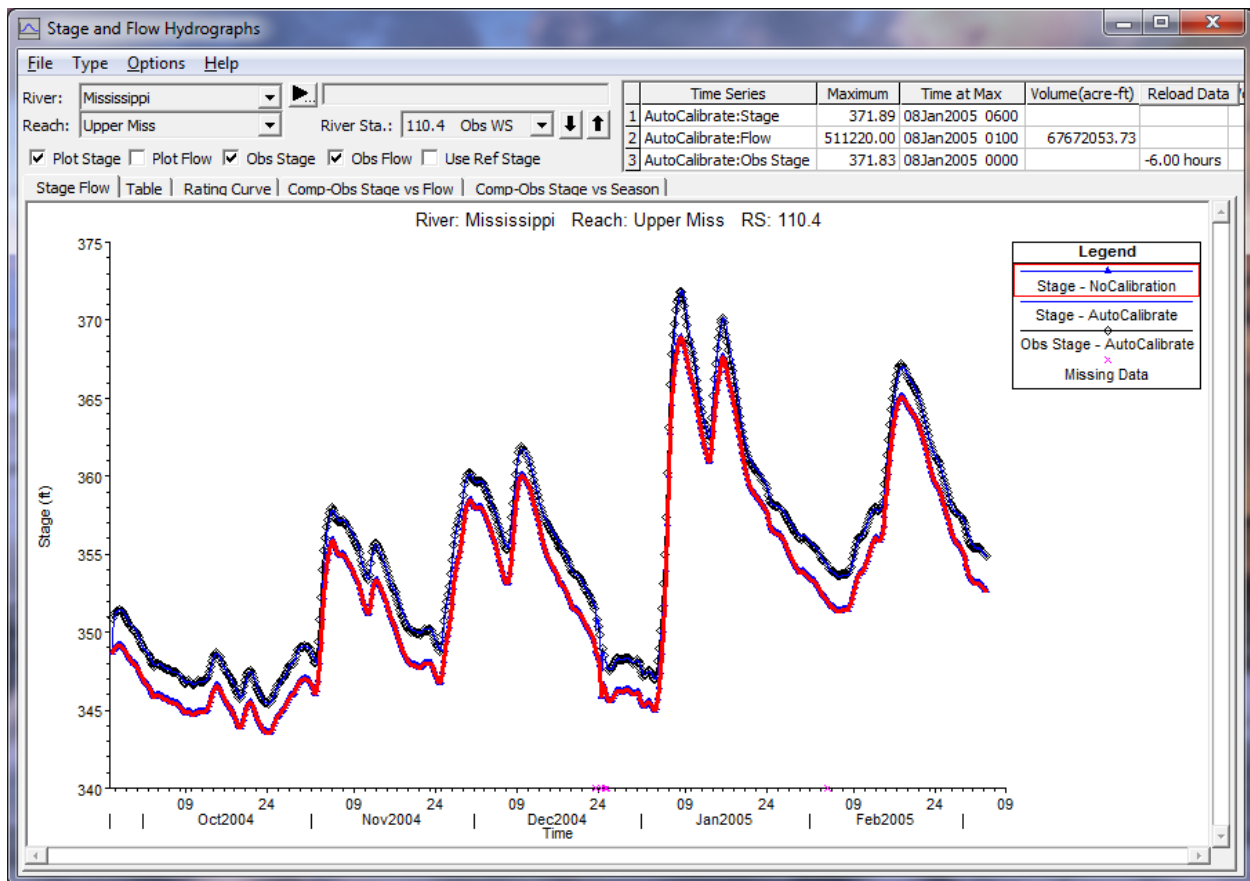

Figure 24-24. Stage and Flow Hydrographs for original uncalibrated run and final calibrated run.

## Summary

This example demonstrated how to set up a gaged unsteady flow model that was calibrated with HEC-RAS's *Automated Roughness Calibration* feature. The user was first shown how to set up the geometric data, unsteady flow data, and the unsteady flow analysis. The primary focus however was demonstrating how to use the *Flow Roughness Factors Editor* and the *Automated Roughness Calibration* feature. Once the model was calibrated, the results were found in a DSS plot from the *Automated Roughness Calibration Editor*. The output was then analyzed by comparing the observed, calibrated, and originally simulated stage hydrographs. The importance of calibrating a model should be made clear from this example. What also should be conveyed is that the *Automated Roughness Calibration* feature makes calibration much quicker and simpler.

## A P P E N D I X A

### References

Barkau, Robert L., 1992. UNET, One-Dimensional Unsteady Flow Through a Full Network of Open Channels, Computer Program, St. Louis, MO.

Federal Highway Administration, 1995. Evaluating Scour at Bridges, Hydraulic Engineering Circular No. 18, U.S. Department of Transportation, Washington D.C.

Federal Highway Administration, 1990. User's Manual for WSPRO - A computer model for water surface profile computations, Publication No. FHWA-IP-89-027, 177 p.

Federal Highway Administration, 1985. Hydraulic Design of Highway Culverts, Hydraulic Design Series No. 5, U.S. Department of Transportation, (September) Washington D.C.

Federal Emergency Management Agency, 1985. "Flood Insurance Study Guidelines and Specifications for Study Contractors," FEMA 37, Washington, D.C.

Hydrologic Engineering Center, 1995. Flow Transitions in Bridge Backwater Analysis, RD-42, U.S. Army Corps of Engineers, Davis, CA.

Hydrologic Engineering Center, 1996. HEC-RAS River Analysis System, Hydraulic Reference Manual, U.S. Army Corps of Engineers, Davis, CA.

Hydrologic Engineering Center, 1996. HEC-RAS River Analysis System, User's Manual, U.S. Army Corps of Engineers, Davis, CA.

Hydrologic Engineering Center, 1995. UNET, A One-Dimensional Unsteady Flow Through a Full Network of Open Channels, User's Manual, U.S. Army Corps of Engineers, Davis, CA.

King, H.W. and E.F. Brater, 1963. Handbook of Hydraulics, Fifth Edition, McGraw Hill Book Company, New York.

Shearman, J.O., 1990. User's Manual for WSPRO - A computer model for water surface profile computations, Federal Highway Administration, Publication No. FHWA-IP-89-027, 177 p.

United States Geological Survey, 1979. Backwater at Bridges and Densely Wooded Flood Plains, Beaver Creek Near Kentwood, Louisiana, Hydrologic Atlas No. HA-601.

Yarnell, D.L., 1934. Bridge Piers as Channel Obstructions, Technical Bulletin 442, U.S. Department of Agriculture, Washington, D.C.